

Strong Fix
System

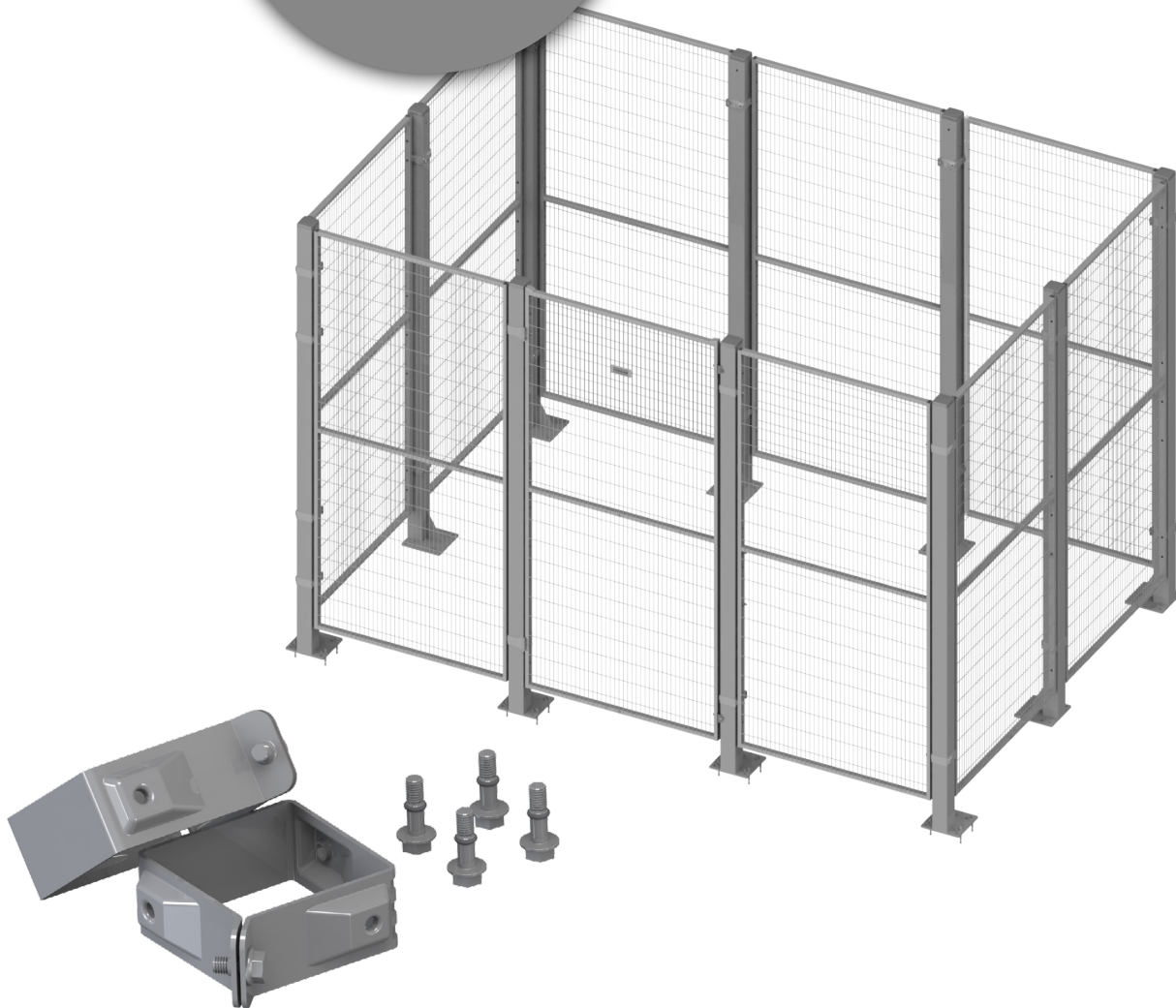

Art no: 88754534 Ver. 01
Print no: 201805-3494-EN

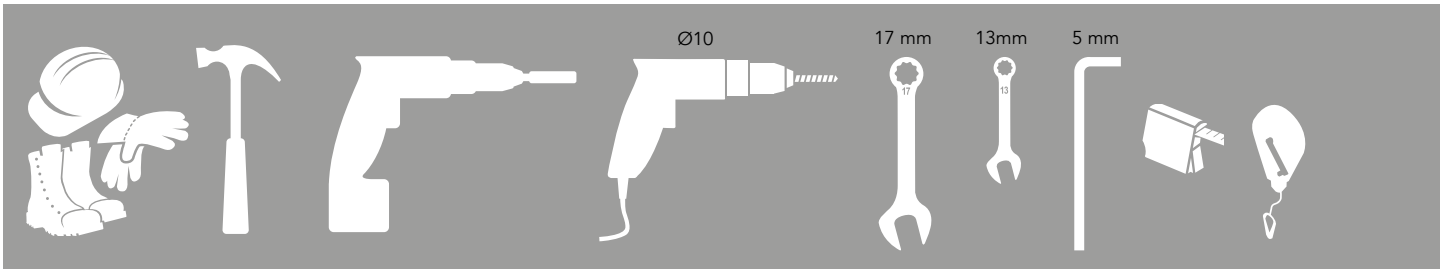

Strong Fix System

Kit Bracket Strong Fix 36700098

x2
80x80
x4
M8x28
x1
80x80
x2
20/30

Kit SMF T-Crossing 36908000

x2
M8x28

Kit Corner Bracket SMF 36700096

x2
x2
M8x28
x2
M8x12

Kit Corner Bracket Threaded 36700097

x2
x4
M8x28

Expander 89050090

M10x80

Adjustment Bolt 89050176

M10x20

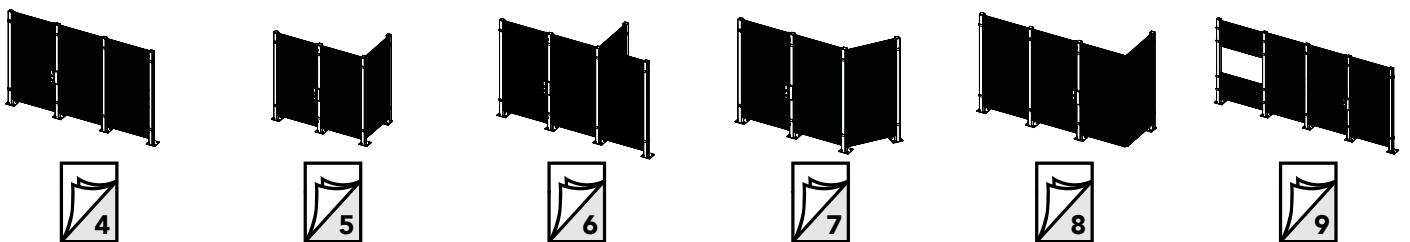
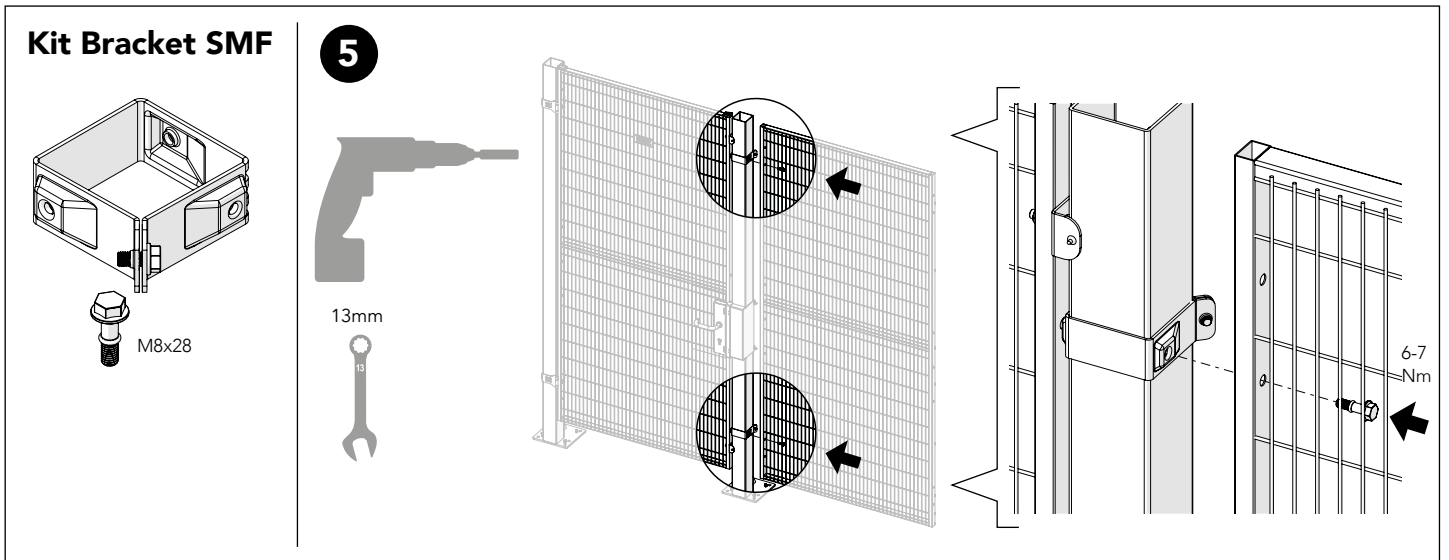
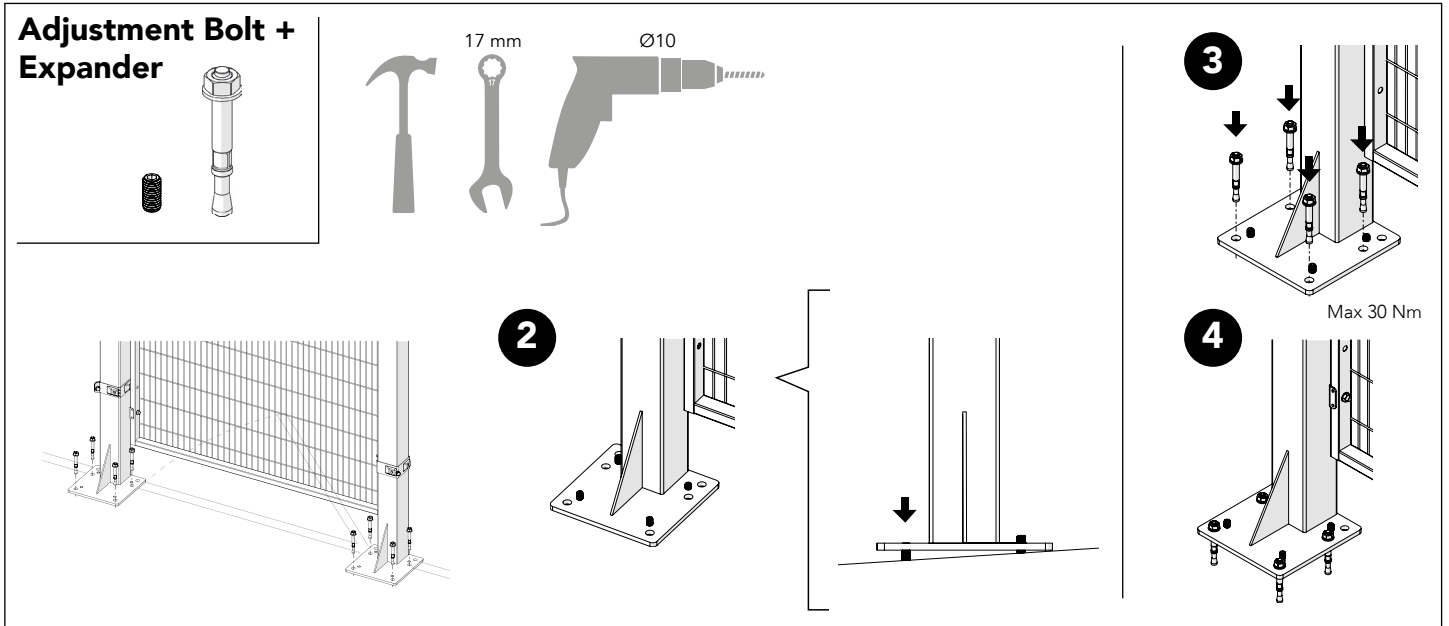
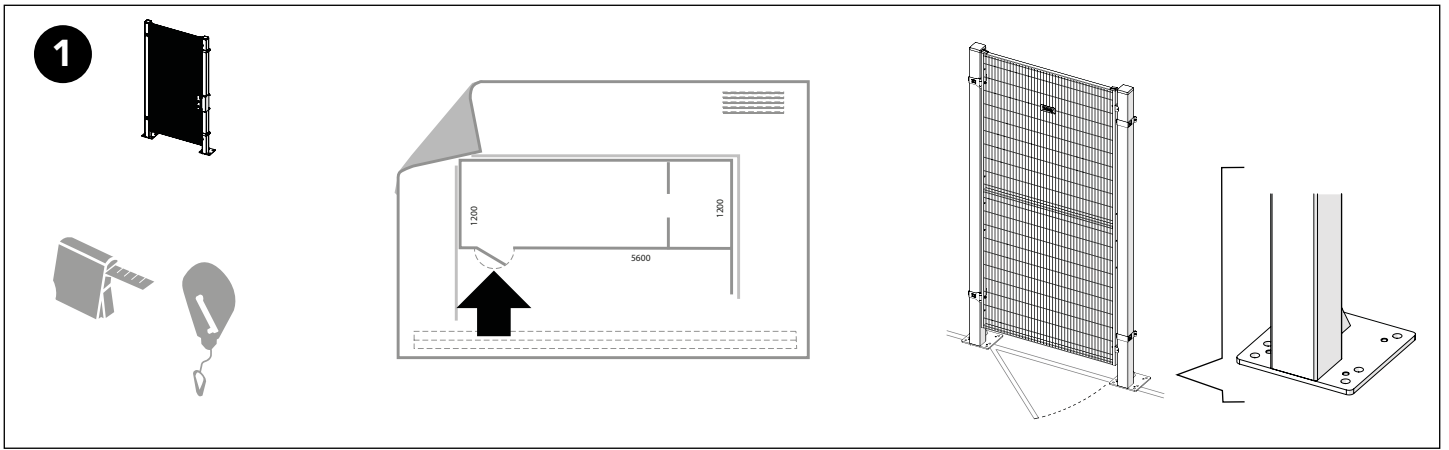

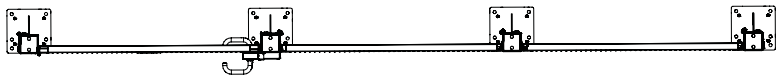
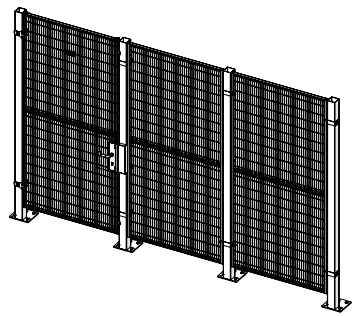

Kit Bracket Strong Fix

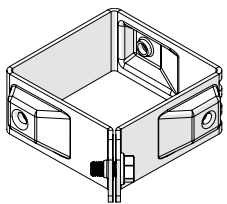

6

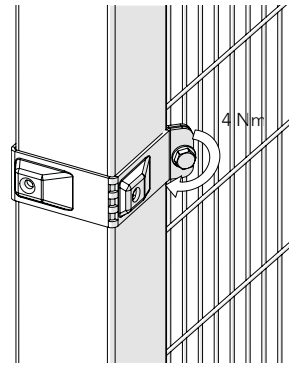
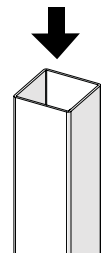
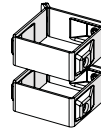
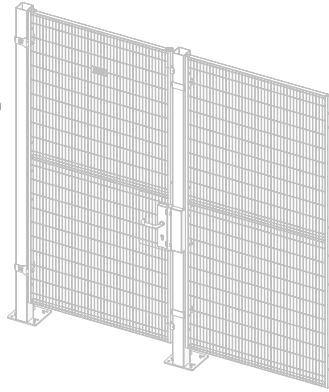
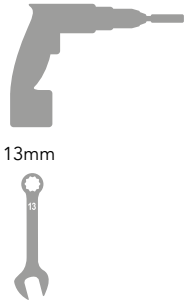

7

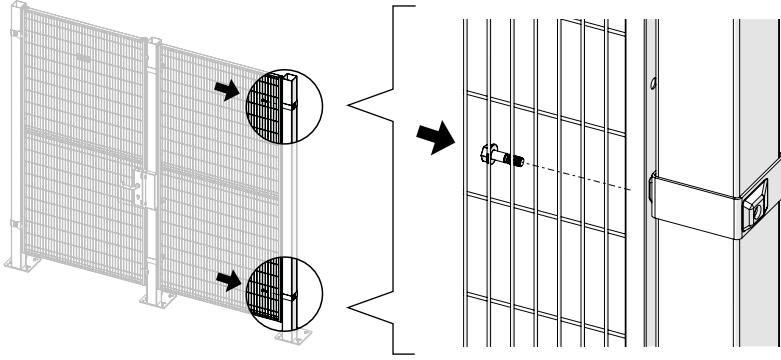

Kit Bracket Strong Fix

10

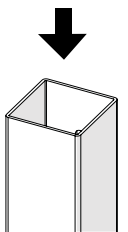
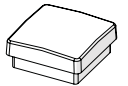
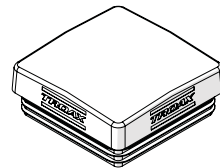

8

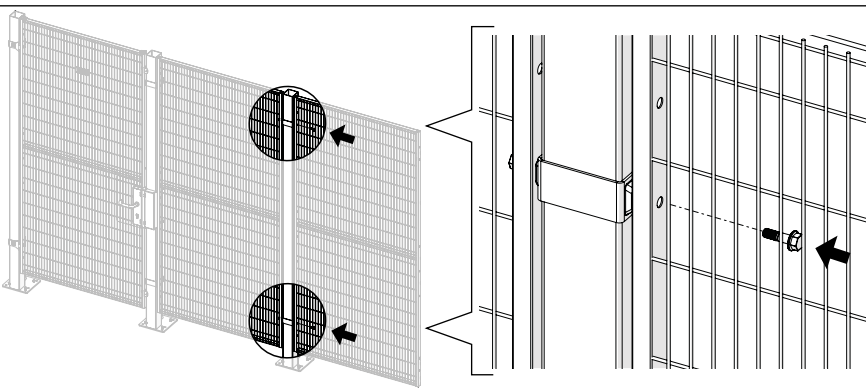

Kit Bracket SMF

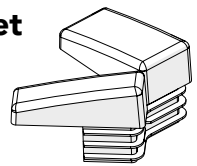

11

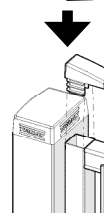
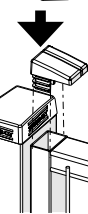
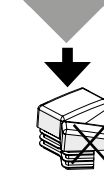
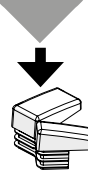

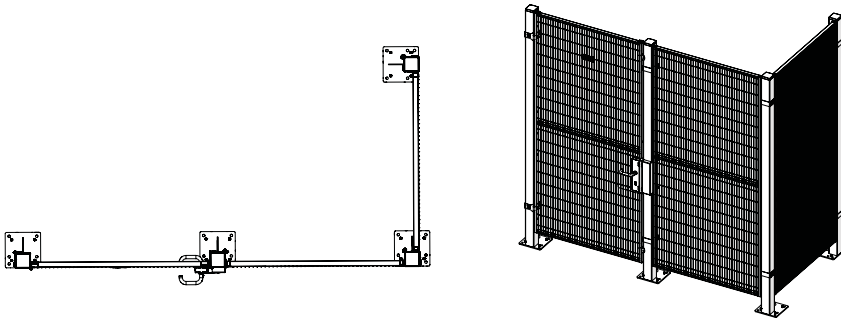

Kit Bracket Strong Fix

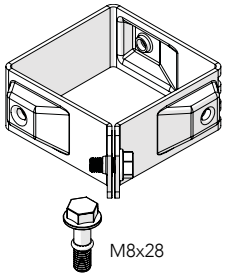

6

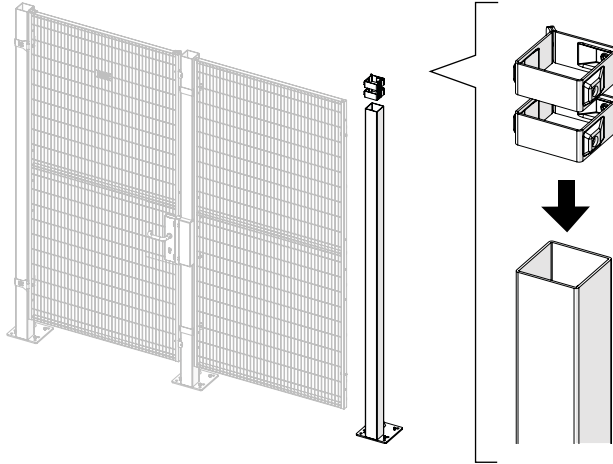
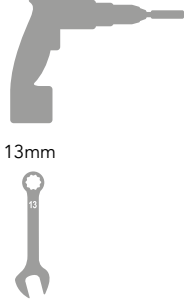

7

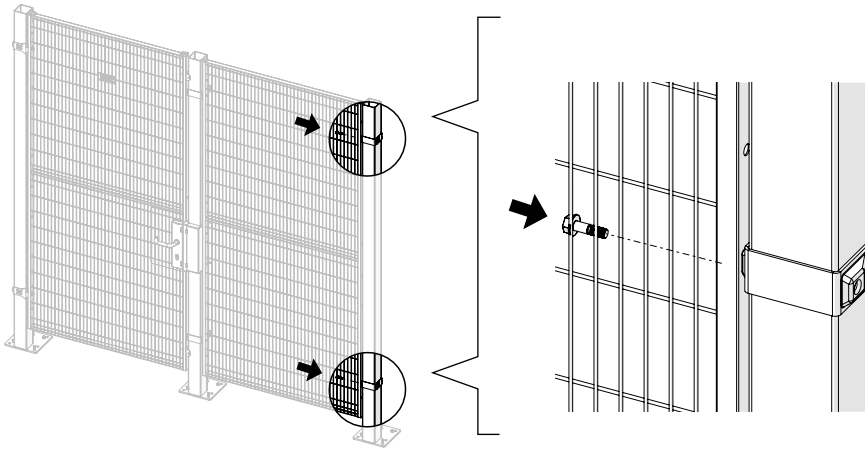

Art.no: 88754534 ver. 01

8

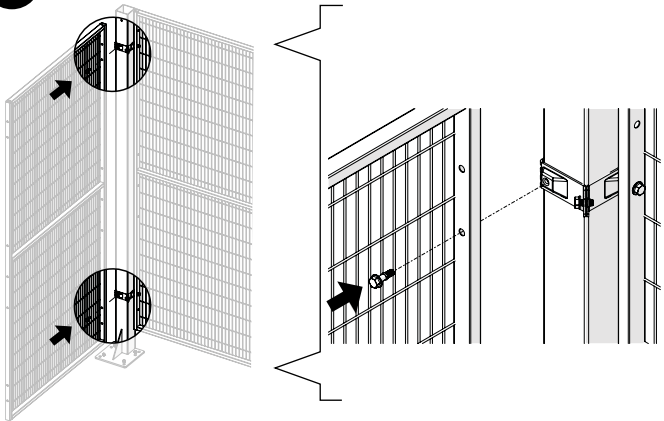

9

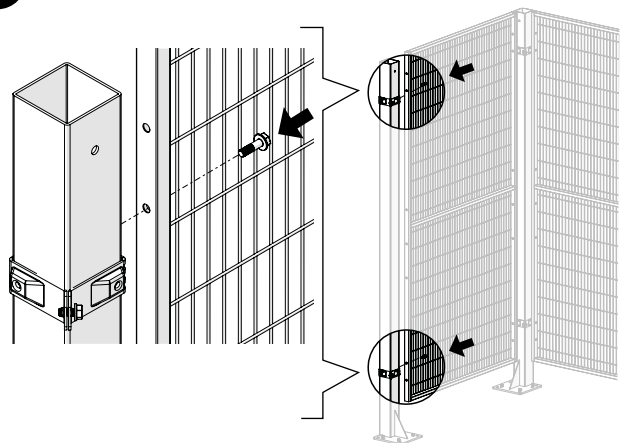

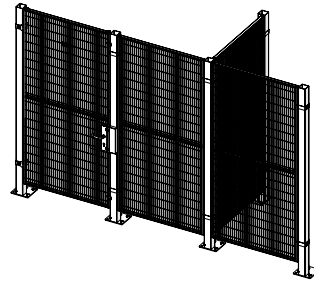
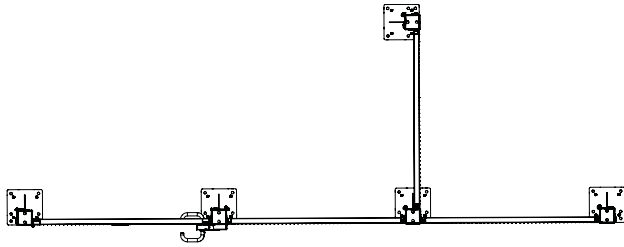

Kit Bracket Strong Fix

6

13mm

M8x28

7

8

9

10 Kit SMF T-crossing

M8x28

11

Art no: 88754534 ver.01

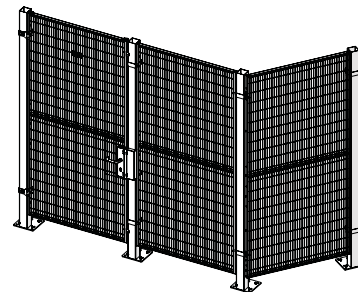
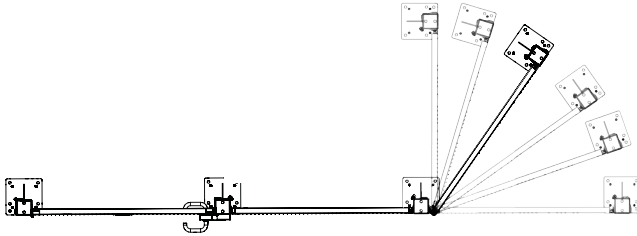

Kit Bracket Strong Fix

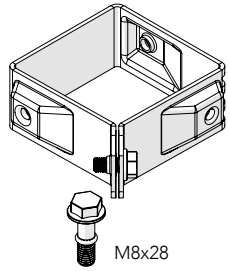

6

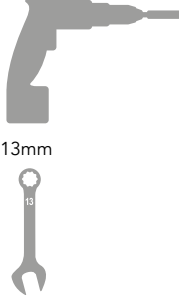

13mm

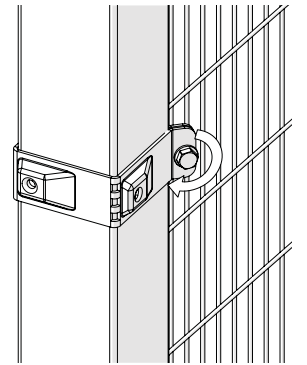
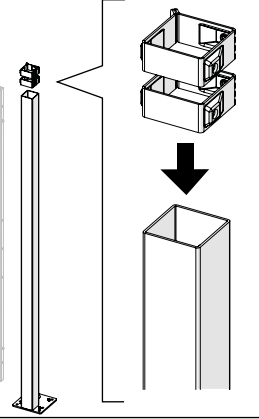
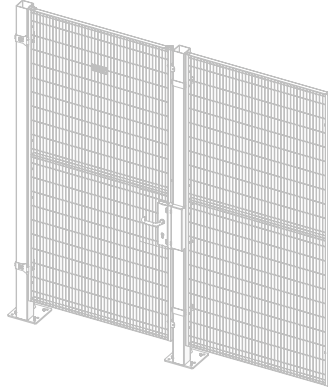

Kit Corner Bracket

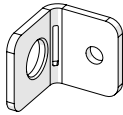

M8x28



M8x12

7

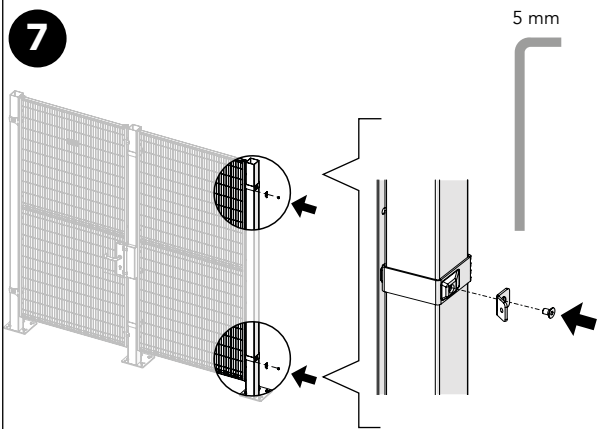

5 mm

8

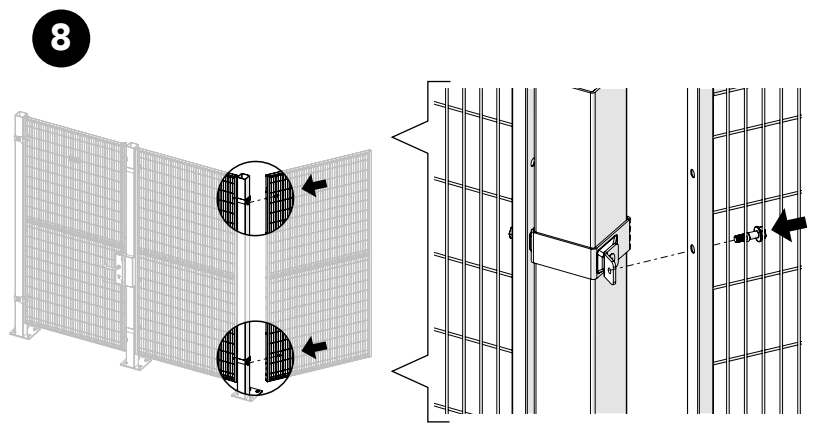

9

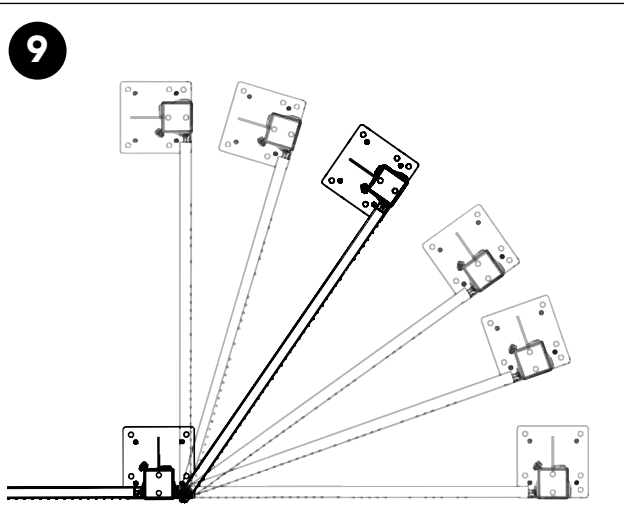

10

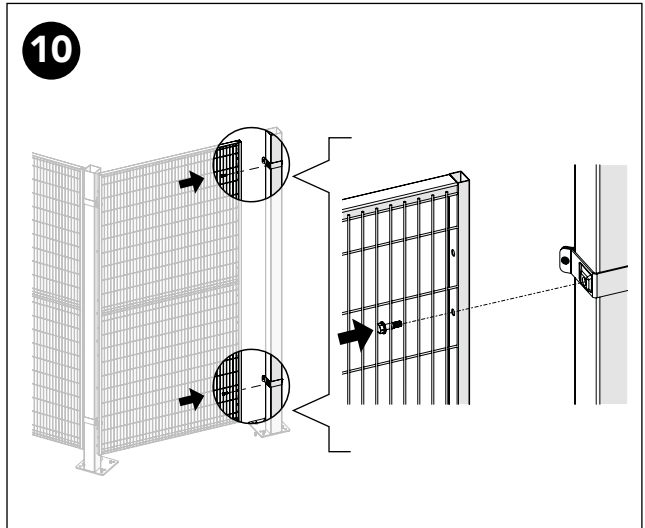

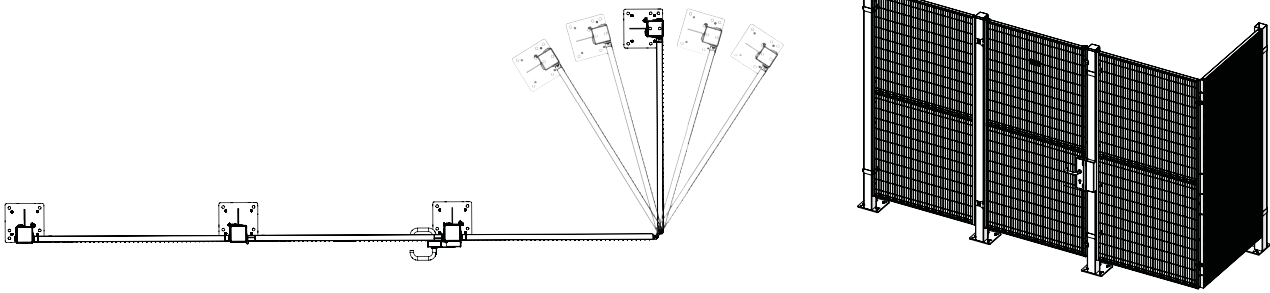

Kit Corner Bracket Threaded

6

M8x28

13mm

This section details the components and tools for step 6. It includes a corner bracket, an M8x28 bolt, and a 13mm wrench. The diagram shows a perspective view of the fence with circular callouts indicating the installation points on the mesh. A detailed inset shows the corner bracket being secured to the vertical post with the bolt and nut.

7

This diagram shows the installation of a vertical post into the mesh. A circular callout provides a close-up view of the post being inserted into the mesh structure. The diagram shows the post being secured to the mesh and the corner bracket.

8

This diagram illustrates the installation of corner brackets. It shows a perspective view of the fence with five brackets being attached to the corners. The diagram shows the brackets being secured to the vertical posts.

9

This diagram shows the installation of a vertical post into the mesh. A circular callout provides a close-up view of the post being inserted into the mesh structure. The diagram shows the post being secured to the mesh and the corner bracket.

Art no: 88754534 ver.01

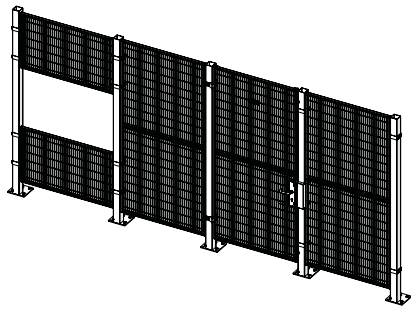

**Kit Bracket
Strong Fix**

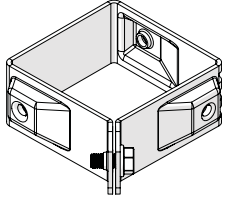

6



13mm

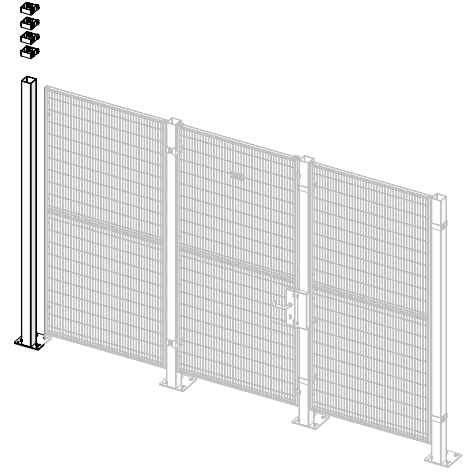
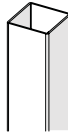
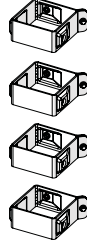

7

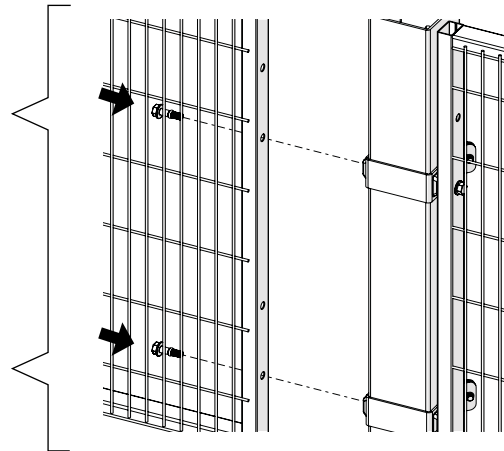
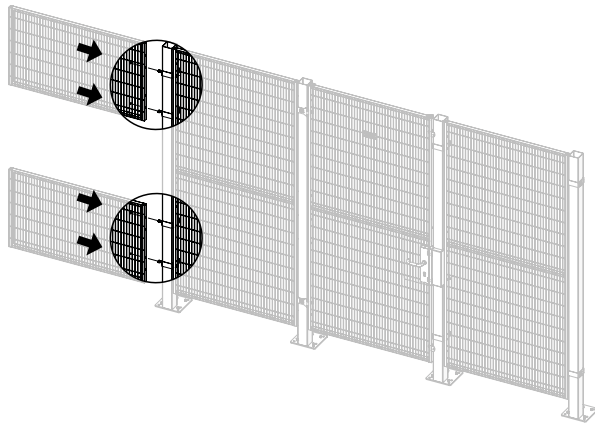

8

