



**TENAX**

**Orto, casa e giardino  
Garden & DIY  
Aménagement jardin  
Casa, huerto y jardín  
Garten & Heimwerker**

Catalogo/Listino prezzi - Catalogue/Price list - Catalogue/Tarif - Catálogo/Lista de precios - Katalog/Preisliste  
IN VIGORE DAL - IN EFFECT SINCE - EN VIGUEUR À COMPTER DE - EN VIGOR DESDE EL - GÜLTIG AB **01.01.2019**

## La filosofia TENAX

Tenax dal 1960 è azienda leader nelle reti in plastica, nei prodotti per il giardinaggio e l'outdoor improvement.

L'alta qualità dei suoi prodotti, l'innovazione continua e l'attenzione al cliente sono alla base della sua filosofia. Grazie all'utilizzo di polimeri di alta qualità e all'expertise nei processi produttivi, Tenax ha ampliato la garanzia sulle reti in plastica e su gran parte delle reti tessute a ben 10 anni. Questo perché siamo sicuri della nostra qualità unica sul mercato.

### DURABILITY



## The TENAX philosophy

Tenax has been a leading business in the field of plastic nets, gardening products and outdoor improvement since 1960.

The high-quality of our products, a continuous innovation and a customer focus are the foundations of our philosophy. Thanks to the use of high-quality polymers and to its expertise in the production processes, Tenax has extended the warranty on its plastic nets and on most of its woven nets to 10 years. Indeed, we are sure about our unique quality on the market.

## La philosophie TENAX

Depuis 1960, Tenax est une entreprise leader dans les filets en plastique, les produits destinés au jardinage et au soin et à l'amélioration extérieure.

La haute qualité de ses produits, l'innovation incessante et l'attention envers le client sont la base de sa philosophie. Grâce à l'utilisation de polymères de haute qualité et une expertise dans les processus de production, Tenax a étendu la garantie sur les filets en plastique ainsi que sur les filets tissés à 10 ans. En effet, nous sommes sûrs de notre qualité unique sur le marché.

## La filosofía TENAX

Tenax es la empresa líder en mallas de plástico, en productos para la jardinería y el outdoor improvement desde 1960.

La alta calidad de sus productos, la continua innovación y la atención al cliente, son la base de su filosofía. Gracias al uso de polímeros de alta calidad y a la experiencia en los procesos de fabricación, Tenax ha ampliado la garantía de las mallas de plástico y de gran parte de las mallas tejidas nada menos que a 10 años. Esto porque estamos seguros de nuestra calidad, única en el mercado.

## Die TENAX-Philosophie

Tenax ist seit 1960 führende Firma für Kunststoffnetze und Produkte für Gartenbau und Outdoor improvement.

Die hohe Qualität der Produkte, die ständige Neuentwicklung und die Aufmerksamkeit gegenüber dem Kunden sind die Grundlage ihrer Philosophie. Dank der Verwendung hochwertiger Polymere und der Expertise in den Herstellungsverfahren hat Tenax die Garantie auf Kunststoffnetze und auf einen Großteil der gewebten Netze auf 10 Jahre verlängert. Weil wir unserer einzigartigen Qualität auf dem Markt sicher sind.

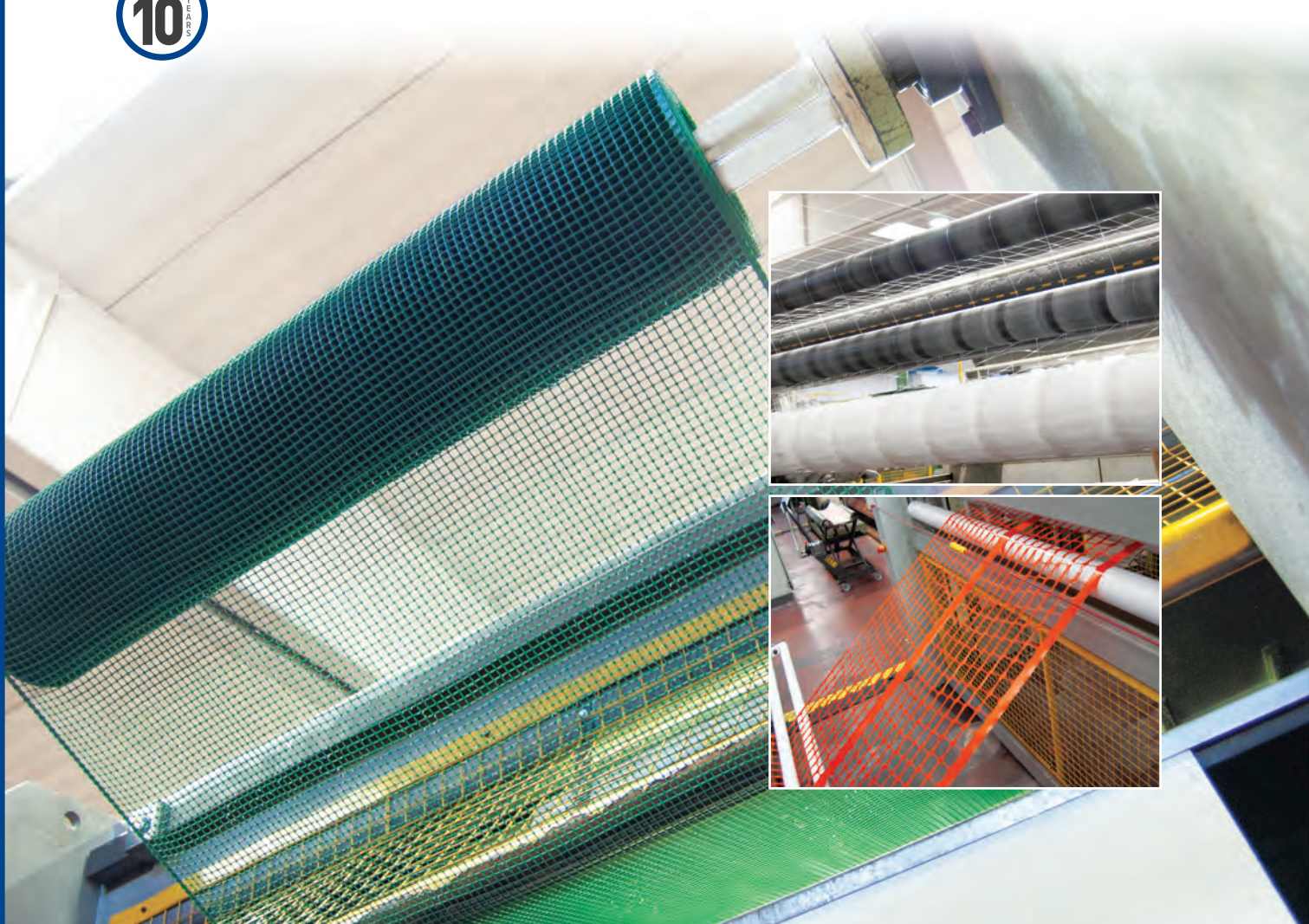



### Perché scegliere i prodotti TENAX

### Why to choose TENAX products

### Pourquoi choisir les produits TENAX

### Los motivos para elegir TENAX

### Gründe um TENAX zu wählen

MARCHIO LEADER	LEADING BRAND	MARQUE LEADER	MARCA LÍDER	FÜHRENDE MARKE
POLIMERI SELEZIONATI E DI QUALITÀ	SELECT AND QUALITY POLYMERS	POLYMÈRES SÉLECTIONNÉS ET DE QUALITÉ	POLÍMEROS SELECCIONADOS Y DE CALIDAD	AUSGEWÄHLTE UND QUALITÄT POLYMERE
PROCESSI DI PRODUZIONE ESCLUSIVI	EXCLUSIVE PRODUCTION PROCESSES	PROCESSUS DE PRODUCTION EXCLUSIFS	PROCESOS DE PRODUCCIÓN EXCLUSIVOS	EXKLUSIVE HERSTELLUNGSVERFAHREN
GARANZIA DI LUNGA DURATA FINO A 10 ANNI	UP TO 10 YEAR WARRANTY	GARANTIE À LONG TERME JUSQU'À 10 ANS	GARANTÍA DE LARGA DURABILIDAD, HASTA 10 AÑOS	BIS ZU 10 JAHRE LANG GARANTIE
RESISTENZA AD AGENTI CHIMICI E ATMOSFERICI	RESISTANCE TO CHEMICALS AND WEATHER ELEMENTS	RÉSISTANCE AUX AGENTS CHIMIQUES ET ATMOSPHÉRIQUES	RESISTENCIA A LOS AGENTES QUÍMICOS Y ATMOSFÉRICOS	CHEMISCHE- UND WITTERUNGSBESTÄNDIGKEIT
QUALITÀ CERTIFICATA	CERTIFIED QUALITY	QUALITÉ CERTIFIÉE	CALIDAD CERTIFICADA	ZERTIFIZIERTE QUALITÄT
CONFORMITÀ ALLE NORMATIVE	COMPLIANCE WITH REGULATIONS	CONFORMITÉ À LA RÉGLEMENTATION	CONFORMIDAD CON LAS NORMATIVAS	ERFÜLLUNG DER RECHTSVORSCHRIFTEN
ESPERIENZA	EXPERIENCE	EXPÉRIENCE	EXPERIENCIA	ERFAHRUNG
FACILITÀ DI INSTALLAZIONE E TUTORIALS	EASY INSTALLATION AND TUTORIALS	INSTALLATION FACILE ET TUTORIEL	FACILIDAD DE INSTALACIÓN Y TUTORIALES	EINFACHE INSTALLIERUNG UND TUTORIAL



## Come vendere meglio i prodotti TENAX

Essere visibili significa staccarsi dal contesto, ovvero entrare in un processo di competizione percettiva per riportare in superficie ciò che il prodotto nasconde. Gli espositori TENAX sono di grande impatto e aiutano nella messa in scena del prodotto e nella creazione di un "negoziò nel negoziò": un'isola verde brillante dove i prodotti TENAX sono i protagonisti assoluti.

## How to sell TENAX products better

Being visible means standing out from the context, that is entering a process of perceptual competition to bring what the product hides to the surface. The TENAX high impact display stands help to make the product stand out and create a "shop within a shop", a bright green island where TENAX products are the protagonists.

## Comment mieux vendre les produits TENAX

Être visible signifie être détaché du contexte, c'est-à-dire rentrer dans un processus de perception de la concurrence pour mettre en évidence ce que cache le produit. Les présentoirs TENAX sont d'un grand impact et aident dans l'introduction du produit et la création d'une «boutique dans un magasin»: une île verte où les produits TENAX se démarquent.

## Cómo vender mejor los productos TENAX

Ser visibles significa distinguirse, es decir, entrar en un proceso de competición percettiva para traer a la superficie lo que esconde el producto. Los expositores TENAX son de gran impacto y ayudan en la puesta en escena del producto y en la creación de una "tienda en la tienda": una isla verde brillante donde los productos TENAX son los protagonistas absolutos.

## Wie man die TENAX Produkte besser verkauft

Sichtbar sein heißt sich vom Umfeld zu lösen, d.h. in eine Wettkampfstimmung zu kommen um das an die Oberfläche zu bringen, was das Produkt versteckt. Die TENAX Aussteller sind von großer Wirkung und helfen dabei das Produkt in Szene zu setzen und ein „Geschäft im Geschäft“ zu schaffen: eine hellgrüne Insel auf der die TENAX Produkte die absoluten Protagonisten sind.





### Merchandising & packaging TENAX

Chiarezza espositiva ed immediata lettura delle categorie: grazie alla consulenza degli esperti Tenax i prodotti vengono suddivisi in cluster omogenei per applicazione e mondo di riferimento.

#### Sell out efficace

Un supporto per la vendita del prodotto, tutte le confezioni sono alla portata del cliente.

#### Valorizzazione

Una bella cornice valorizza ciò che si sta vendendo.

#### Percezione della gamma

La cromia e l'ordine aiutano a dare un colpo d'occhio importante all'interno del punto vendita.

#### Funzionalità

Gli espositori TENAX, oltre ad esser belli da vedere sono anche funzionali e facili da posizionare.

#### Le confezioni informano

Su ogni confezione il consumatore trova suggerimenti per l'utilizzo e indicazioni per l'applicazione.

### TENAX merchandising & packaging

A clear arrangement and an immediate understanding of the categories: thanks to Tenax experts' advice, products are divided in homogeneous clusters according to their application and field.

#### Effective sales

A support for product sales, all the packs are within the customer's reach.

#### Enhancement

A beautiful frame enhances what you are selling.

#### Perception of the range

The colours and arrangement help to give an important view within the point of sale.

#### Functionality

Besides being beautiful to look at, the TENAX display stands are also practical and easy to place.

#### Packs provide information

Consumers find recommendations for use and application guidelines.

### Merchandising et emballage TENAX

La clarté et la lecture immédiate des catégories: grâce aux conseils des experts Tenax, les produits sont divisés en groupes homogènes par application et gamme de référencement.

#### Vente efficace

Un soutien à la vente du produit, tous les paquets sont à la portée du client.

#### Valorisation

Un cadre magnifique améliore ce que vous vendez.

#### Perception de la gamme

Les couleurs et l'agencement aident à donner un aperçu important dans le point de vente.

#### Fonctionnalité

Outre l'impact visuel, les présentoirs TENAX sont également fonctionnels et faciles à localiser.

#### Les paquets informent

Sur le paquet, le consommateur trouve des suggestions pour les instructions d'utilisation et d'application.

### Merchandising & packaging TENAX

Claridad de exposición e inmediata lectura de las categorías: gracias al asesoramiento de los expertos Tenax, los productos se subdividen en grupos homogéneos por aplicación y ámbito de referencia.

#### Sell out eficiente

Un apoyo para la venta del producto, todo al alcance del consumidor.

#### Valorización

Un bonito marco valoriza lo que se está vendiendo.

#### Percepción de la gama

La tonalidad y el orden producen un impacto visual dentro del punto de venta.

#### Funcionalidad

Los expositores TENAX, además de ser decorativos, son también funcionales y fáciles de colocar.

#### Las unidades informan

En cada unidad el consumidor encuentra sugerencias para el uso e indicaciones para su empleo.

### TENAX Merchandising & Verpackung

Klarheit in der Ausstellung und sofortiges Erkennen der Kategorien: dank der Beratung der Tenax Experten werden die Produkte in homogene Cluster unterteilt, nach Anwendung und Bezugspunkt.

#### Effektiver Verkauf

Unterstützung beim Verkauf des Produkts, alle Packungen befinden sich in Reichweite des Kunden.

#### Aufwertung

Ein schöner Rahmen wertet das auf, was Sie verkaufen.

#### Die Wahrnehmung des Sortiments

Die Farben und die Anordnung ermöglichen einen guten Überblick innerhalb der Verkaufsstelle.

#### Funktionalität

Abgesehen von ihrem schönen Aussehen, sind die TENAX Aussteller auch funktional und einfach aufzustellen.

#### Die Verpackungen informieren

Auf jeder Verpackung findet der Verbraucher Ratschläge zur Verwendung und Anwendungshinweise.





### RETI PER CASA E GIARDINO

Reti in plastica  
Recinzioni in plastica  
Reti in metallo  
Bordure decorative

### HOME & GARDEN MESHERS

Plastic meshes  
Plastic fences  
Wire meshes  
Decorative lawn edging



### SCHEMATURE DECORATIVE

TexStyle schermatura di design  
Reti tessute  
Siepi sintetiche  
Cannicci sintetici

### DECORATIVE AND PRIVACY SCREENING

TexStyle stylish screen  
Woven nets  
Synthetic hedges  
Synthetic reeds



### PRATI SINTETICI, SALVAPRATO

Prati sintetici  
Salvaprato

### SYNTHETIC LAWNS, LAWN REINFORCEMENT

Synthetic lawns  
Lawn reinforcement



### COLTIVARE L'ORTO

Veli protettivi  
Tunnel e film  
Antierbacce e pacciamatura  
Reti per piante rampicanti e tutori  
Protezione colture

### CULTIVATE A VEGETABLE GARDEN

Protective fleeces  
Tunnels and plastic films  
Weed control and mulching  
Climbing plants nets and supports  
Crop protection



### MANUTENZIONE GIARDINO E CASA

Tralici e mini tutori  
Borsoni da giardino  
Reti per grondaie e tombini  
Teli e film protettivi  
Zanzariere

### GARDEN AND HOME CARE

Trellises and mini stakes  
Garden bags  
Meshes for gutters and manholes  
Protective films and covers  
Mosquito nets



### LINEA PET

### PET LINE



### ACCESSORI

### ACCESSORIES



### MERCHANDISING

### MERCHANDISING

<b>FILETS POUR MAISON ET JARDIN</b>	<b>MALLAS PARA LA CASA Y EL JARDÍN</b>	<b>NETZE FÜR HAUS UND GARTEN</b>	<b>7</b>	<b>1</b>
Filets en plastique	Mallas plásticas	Kunststoffnetze	8	
Clôtures en plastique	Cercas de plástico	Kunststoffumzäunungen	21	
Filets métalliques	Mallas metálicas	Drahtgitter	27	
Bordures décoratives	Borduras decorativas	Dekorative Rasenkanten	30	
<b>OCCULTATIONS DÉCORATIVES</b>	<b>OCULTACIÓN DECORATIVA</b>	<b>DEKORATIVER SICHTSCHUTZ</b>	<b>35</b>	<b>2</b>
TexStyle occultation design	TexStyle ocultación de diseño	TexStyle Designabschirmung	36	
Filets tissés	Mallas tejidas	Sichtschutzgewebe	44	
Haies synthétiques	Setos artificiales	Synthetische Hecken	56	
Cannes synthétiques	Cañizos artificiales	Synthetische Schilfe	70	
<b>GAZONS SYNTHÉTIQUES, GRILLES POUR SOLS</b>	<b>CÉSPEDES ARTIFICIALES, PROTECCIÓN DEL CÉSPED</b>	<b>KUNSTRASEN, RASENGITTER</b>	<b>73</b>	<b>3</b>
Gazons synthétiques	Céspedes artificiales	Kunstrasen	74	
Grilles pour sols	Protección del césped	Rasengitter	81	
<b>CULTIVER UN POTAGER</b>	<b>CULTIVAR UN HUERTO</b>	<b>DEN GARTEN BESTELLEN</b>	<b>83</b>	<b>4</b>
Toiles de protection	Velos protectores	Schutzvliese	86	
Mini serre et films	Túnel y film	Tunnel und Folie	91	
Anti-mauvaises herbes et paillage	Antihierbas y acolchamiento	Unkrautbekämpfung und Mulchen	96	
Filets et supports pour plantes grimpantes	Mallas para trepadoras y tutores	Netze für Kletterpflanzen und Stützen	102	
Protection culture	Protección para cultivos	Pflanzenschutz	108	
<b>ENTRETIEN MAISON ET JARDIN</b>	<b>MANTENIMIENTO DE LA CASA Y EL JARDÍN</b>	<b>INSTANDHALTUNG HAUS UND GARTEN</b>	<b>115</b>	<b>5</b>
Treillis et mini tuteurs	Enrejados y minitutores	Gitter und Mini-Stützen	116	
Sacs de jardin	Bolsas para jardín	Gartentaschen	119	
Filets pour gouttières et égouts	Mallas para canalones y alcantarillas	Gitter für Dachrinnen und Abflüsse	122	
Toiles et films de protection	Tejidos y films de protección	Abdeckungen und Schutzfolien	124	
Moustiquaires	Mosquiteras	Mückennetze	127	
<b>LIGNE ANIMAUX</b>	<b>LINEA PET</b>	<b>HAUSTIERREIHE</b>	<b>129</b>	<b>6</b>
<b>ACCESSOIRES</b>	<b>ACCESORIOS</b>	<b>ZUBEHÖR</b>	<b>133</b>	<b>7</b>
<b>MERCHANDISING</b>	<b>MERCHANDISING</b>	<b>MERCHANDISING</b>	<b>149</b>	<b>8</b>





**RETI PER CASA  
E GIARDINO**
**HOME & GARDEN  
MESHES**
**FILETS  
POUR MAISON  
ET JARDIN**
**MALLAS  
PARA LA CASA  
Y EL JARDÍN**
**NETZE  
FÜR HAUS  
UND GARTEN**

Reti in plastica	Plastic meshes	Filets en plastique	Mallas plásticas	Kunststoffnetze	8
Recinzioni in plastica	Plastic fences	Clôtures en plastique	Cercas de plástico	Kunststoffumzäunungen	21
Reti in metallo	Wire meshes	Filets métalliques	Mallas metálicas	Drahtgitter	27
Bordure decorative	Decorative lawn edging	Bordures décoratives	Borduras decorativas	Dekorative Rasenkanten	30

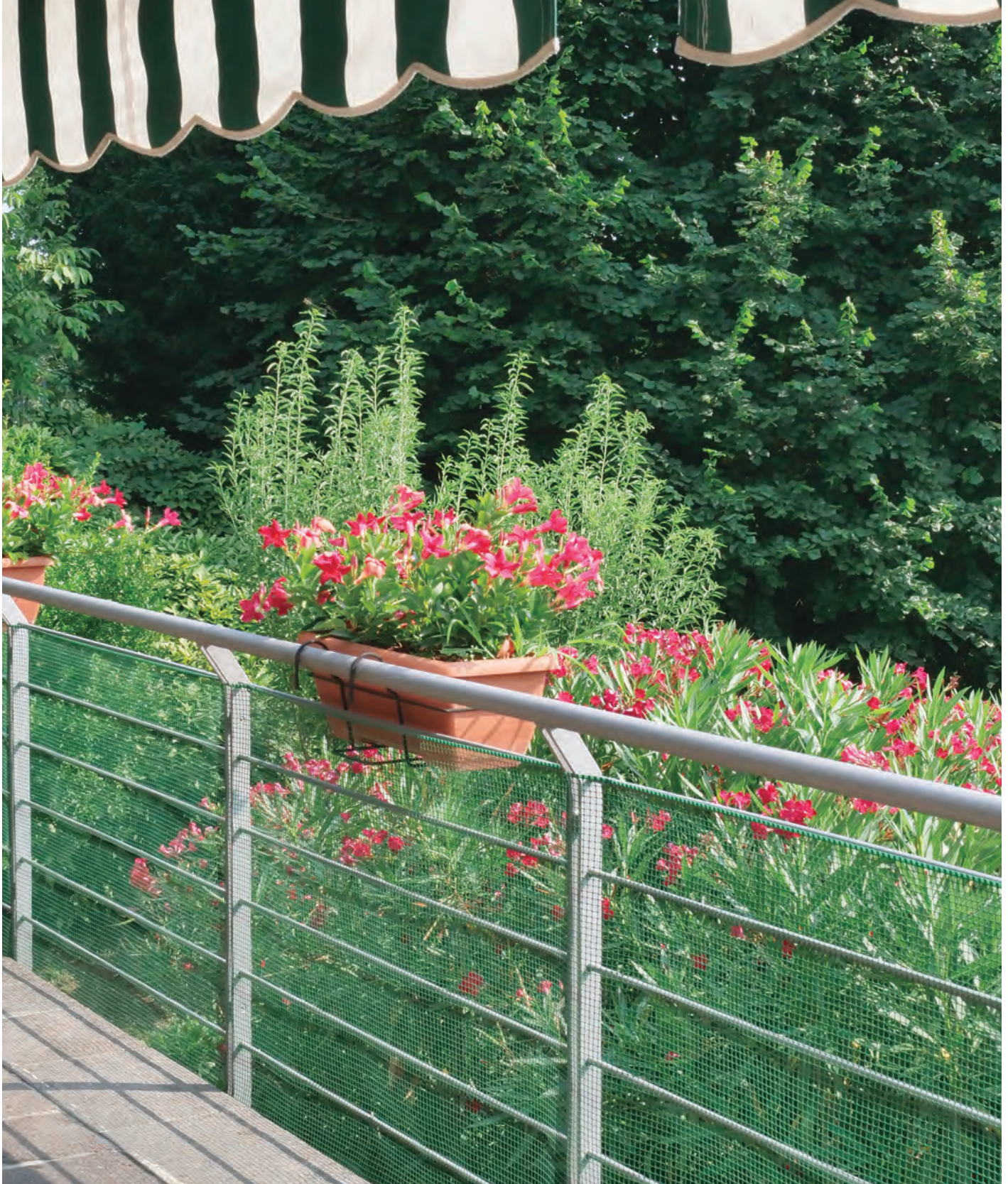

### Reti in plastica

Le reti in plastica TENAX rappresentano una soluzione semplice, versatile e colorata per molteplici applicazioni a seconda della maglia e del colore. Maneggevoli, facilmente sagomabili e semplici da installare, sono prodotte con polimeri completamente riciclabili, atossici e di prima qualità.

### Plastic meshes

TENAX plastic meshes provide a simple, versatile and colourful solution for a wide range of uses depending on the size and the colour of the mesh. They are easy to shape and install and are made from recyclable, non-toxic, high quality materials.

### Filets en plastique

Les filets plastiques TENAX, décoratifs, polyvalents et colorés, peuvent être utilisés dans de multiples applications selon la maille et les couleurs. Pratiques et faciles à installer, ils sont fabriqués avec des matériaux de qualité, recyclables et non toxiques.

### Mallas plásticas Kunststoffnetze

Las mallas de plástico TENAX son una solución sencilla, versátil y decorativa ideal para múltiples aplicaciones según el tipo de malla y el color. Manejables, fáciles de cortar e instalar, están fabricadas con polímeros completamente reciclables, atóxicos y de primera calidad.

TENAX Kunststoff-Schutzgitter bieten einfache und vielseitige Lösungen in verschiedensten Farben und für eine Vielzahl von Anwendungen. Abhängig von der Größe und der Farbe. Sie sind leicht zu formen und anzubringen und sind aus wieder verwertbaren, ungiftigen, hochqualitativen Materialien.

## TENAX QUADRA: L'Originale dal 1968

TENAX QUADRA, in occasione dei suoi 50 anni, è orgogliosa di estendere la sua **garanzia a 10 anni** grazie all'uso esclusivo di polimeri vergini di prima qualità e all'altissima expertise produttiva.

TENAX QUADRA:

- Supera brillantemente la "prova strappo";
- Ha una cimosa spessa e regolare;
- Unica sul mercato ad essere realizzata anche in altezza 1,5 m;
- Ha colori brillanti ed inimitabili come il verde e l'argento.

## TENAX QUADRA: The original since 1968

TENAX QUADRA, on the occasion of its 50th anniversary, is proud to extend its **warranty to 10 years** thanks to the exclusive use of top-quality virgin polymers and to a high productive expertise.

TENAX QUADRA:

- Is highly tear-resistant;
- Has a thick and regular selvedge;
- Is the only one on the market produced also with a height of 1.5 m;
- Has bright and inimitable colours like green and silver.

## TENAX QUADRA: L'original depuis 1968

TENAX QUADRA, à l'occasion de ses 50 ans, est fière d'étendre sa garantie à 10 ans grâce à l'usage exclusif de polymères vierges de première qualité et une grande expertise en matière de production.

TENAX QUADRA:

- Surmonte brillamment le «test de déchirure»;
- Possède une lisière épaisse et régulière;
- Unique sur le marché à être réalisé également en 1,5 m de hauteur;
- Couleurs vives et inimitables comme le vert et l'argent.

## TENAX QUADRA: La Original desde 1968

TENAX QUADRA, con ocasión de sus 50 años, se siente orgullosa de extender su garantía a 10 años gracias al uso exclusivo de polímeros vírgenes de primera calidad y a la altísima experiencia productiva.

TENAX QUADRA:

- Supera brillantemente la "prueba de resistencia a la rotura";
- Tiene un borde reforzado grueso y regular;
- Única en el mercado también con una altura de 1,5 m;
- Tiene colores brillantes e inimitables como el verde y el plata.

## TENAX QUADRA: Das Original seit 1968

Zur Gelegenheit seiner 50 Jahre ist TENAX QUADRA stolz seine Garantie auf 10 Jahre zu verlängern, dank der exklusiven Verwendung von hochwertigen reinen Polymeren und der hohen Produktions-Expertise.

TENAX QUADRA:

- Besteht den "Reisstest" glänzend;
- Hat eine dicke und regelmäßige Webkante;
- Das einzige auf dem Markt, das auch in der Höhe 1,5 m hergestellt wird;
- Hat leuchtende und unnachahmbare Farben wie grün und silber.

DURABILITY



## Durability 10 years

TENAX ha esteso la Garanzia a 10 anni sulla maggior parte delle reti in plastica che produce.

TENAX has extended the warranty on its plastic nets and on most of its woven nets to 10 years.

TENAX a étendu la garantie sur les filets en plastique ainsi que sur les filets tissés à 10 ans.

TENAX ha ampliado la garantía de las mallas de plástico y de gran parte de las mallas tejidas nada menos que a 10 años.

TENAX hat die Garantie auf Kunststoffnetze und auf einen Großteil der gewebten Netze auf 10 Jahre verlängert.



TENAX QUADRA  
The Original





1

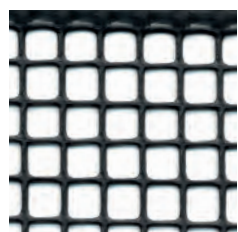

10x10 mm



**Multiuso ecologica.**  
La maglia tradizionale Quadra 10 diventa Eco, prodotta con plastica 100% riciclata per un basso impatto ambientale. Ideale come protezione aggiuntiva su recinzioni e cancellate e rifinita con bordi non taglienti su entrambi i lati.

**The ECO mesh.**  
The traditional Quadra 10 mesh goes Eco! Produced from 100% recycled plastic is now fully environmentally friendly. Recommended for protection on fences and gates, finished off with smooth edges on both sides.

**Grillage en plastique écologique réutilisable.**  
La maille traditionnelle Quadra 10 devient Eco! Produit avec 100% de plastique recyclé pour un faible impact environnemental. Idéal comme protection supplémentaire sur les clôtures et les portails, avec finitions sans bords vifs des deux cotés.

**Malla plástica multiuso ecológica.**  
La malla cuadrada tradicional pero fabricada con plástico 100% reciclado y completamente reciclable, para un menor impacto ambiental. Ideal como protección para balcones y terrazas. Está protegida con bordes no cortantes en los extremos.

**Das Öko-Mehrweck Netz.**  
Das bekannte Quadra 10 Netz wird Ökologisch! Für eine geringe Umweltbelastung wird dieses Netz aus 100% recyceltem Kunststoff hergestellt. Ideal als zusätzlicher Schutz für Zäune und Tore, abgeschlossen mit glatten Kanten auf beiden Seiten.

Cod.	m	-	EAN	N° x	x	x	€ m²	€ m	€	€
1A140230	1.00x5	■	8002929113030	6	24	-	-	-	12,10	72,60
1A140231	1.00x10	■	8002929113047	6	14	-	-	-	21,60	129,60
1A140389	1.00x50	■	8002929114327	-	-	24	1,18	1,18	-	59,00
1A140399	1.00x50	■	8002929114433	-	-	24	1,18	1,18	-	59,00
1A170372	1.00x50	■	8002929124364	-	-	24	1,18	1,18	-	59,00
1A170373	1.00x50	□	8002929124371	-	-	24	1,18	1,18	-	59,00

QUADRA 05



**QUADRA 05**

UV TREATED

REINFORCED

DURABILITY

TOP QUALITY  
MATERIAL

Since 1968 - The original

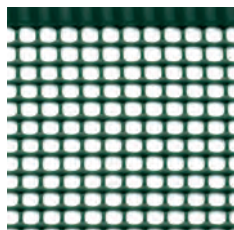

5x5 mm

**La più venduta  
per i balconi.**

Rifinita con bordi non taglienti su entrambi i lati, si installa sulle ringhiere dei balconi per evitare la caduta di oggetti anche molto piccoli.

**The bestseller  
for balconies.**

Smallest mesh size and unsharp edging on both sides making it the best solution for balconies and terraces.

**Le plus vendu  
pour les balcons.**

Arasée sur les deux cotés, peut être installée sur les balustrades des balcons ou comme protection supplémentaire à maille serrée pour portails et clôtures.

**La más vendida  
para balcones.**

Malla con refuerzos no cortantes en los bordes de ambos lados, usada en balcones y terrazas para evitar la caída de objetos, incluso muy pequeños.

**Das meistverkaufte  
für Balkone.**

Mit weichen Kanten auf beiden Längsseiten kann er an Balkongeländern angebracht werden, um zu vermeiden, dass selbst kleinste Objekte herunterfallen.

Cod.	m	-	EAN	N° x	x	x	€ m <sup>2</sup>	€ m	€	€
1A030230	0.50x5		8002929064165	12	24	-	-	-	8,55	102,60
72160118	1.00x5		8002929035646	6	24	-	-	-	13,52	81,12
1A140409	1.00x5		8002929114495	6	24	-	-	-	13,79	82,74
1A140410	1.00x5		8002929114501	6	24	-	-	-	13,52	81,12
1A080275	1.50x5		8002929085795	6	12	-	-	-	20,77	124,62
1A100321	1.50x5		8002929093608	6	15	-	-	-	21,19	127,14
1A100323	1.50x5		8002929093615	6	15	-	-	-	20,77	124,62



	1A030189	0.50x30		8002929063748	-	-	50	1,60	0,80	-	24,00
	62610308	1.00x30		8002929041456	-	-	50	1,52	1,52	-	45,60
	62610301	1.00x30		8002929059406	-	-	25	1,52	1,52	-	45,60
	62610508	1.00x50		8002929034953	-	-	32	1,45	1,45	-	72,50
	62610501	1.00x50		8002929034403	-	-	32	1,45	1,45	-	72,50



Con contametri  
With meter counter  
Avec compteurs métriques  
Con cinta métrica  
Mit Meterzähler

QUADRA 05

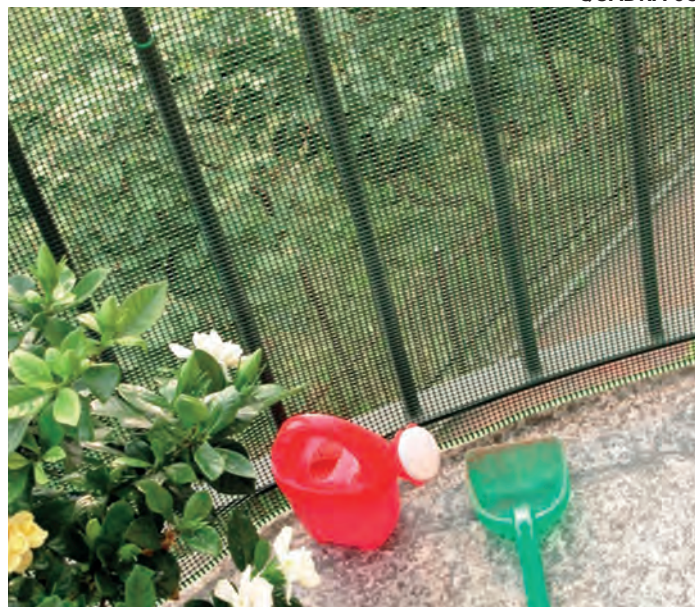

**QUADRA 10**



Since 1968 - The original

1

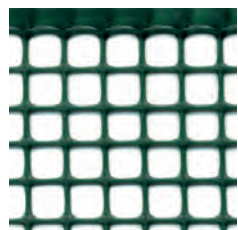

10x10 mm



**Multiuoso.**

È la maglia più venduta ed utilizzata, proposta in un'ampia gamma di formati e colori. Perfetta anche per i balconi perché rifinita con bordi non taglianti sui due lati.

**Multi-purpose.**

The best selling and versatile mesh, in a wide range of colours, to fit to railings. Safe and user-friendly solution everywhere, in house and garden.

**Multi-usage.**

Proposée dans une vaste gamme de formats et de couleurs, à associer à n'importe quelle clôture ou barrière. Parfaite pour les balcons grâce à ses bords arasés des deux côtés.

**Malla plástica multiuso.**

Disponible en una amplia gama de formatos y colores, para combinar con cualquier cerca o valla. Perfecta incluso para barandillas pues está acabada con bordes no cortantes.

**Multifunktions-Zaun.**

Der meist verkaufte und verwendete Zaun aus Kunststoff mit einer Vielzahl an Abmessungen und Farben, um sich an alle Zäune oder Tore anzupassen. Ideal auch für Balkone, da die Kanten keine scharfen Ränder haben.

Cod.	m	-	EAN	N° x	x	x	€ m <sup>2</sup>	€ m	€	€
------	---	---	-----	------	---	---	------------------	-----	---	---

1A100300	0.50x3	■	8002929093431	12	24	-	-	-	6,06	72,72
72020218	0.50x5	■	8002929000408	12	24	-	-	-	8,55	102,60
72020212	0.50x5	■	8002929050601	12	24	-	-	-	8,72	104,64
1A030218	0.50x5	■	8002929064073	12	24	-	-	-	8,55	102,60
1A100307	1.00x3	■	8002929093509	6	24	-	-	-	9,15	54,90
1A100304	1.00x3	■	8002929093479	6	24	-	-	-	9,33	55,98
1A100306	1.00x3	■	8002929093493	6	24	-	-	-	9,15	54,90
1A100305	1.00x3	□	8002929093486	6	24	-	-	-	9,15	54,90
72020118	1.00x5	■	8002929000453	6	24	-	-	-	13,52	81,12
72020112	1.00x5	■	8002929047762	6	24	-	-	-	13,79	82,74
72020117	1.00x5	■	8002929000347	6	24	-	-	-	13,52	81,12
72020111	1.00x5	□	8002929000682	6	24	-	-	-	13,52	81,12
1A050288	1.00x5	■	8002929072924	6	24	-	-	-	13,52	81,12
1A100301	1.00x10	■	8002929093448	6	14	-	-	-	24,00	144,00
1A100302	1.00x10	■	8002929093455	6	14	-	-	-	24,48	146,88
1A100303	1.00x10	■	8002929093462	6	14	-	-	-	24,00	144,00
1A170238	1.50x5	■	8002929123381	6	12	-	-	-	20,77	124,62
1A170240	1.50x5	■	8002929123404	6	12	-	-	-	21,19	127,14
1A170239	1.50x5	■	8002929123398	6	12	-	-	-	20,77	124,62

Up to 1.50 m TENAX exclusive!



62333308	0.50x30	■	8002929036803	-	-	40	1,42	0,71	-	21,30
1A160356	0.50x30	■	8002929121585	-	-	40	1,44	0,72	-	21,60
1A030190	0.50x30	■	8002929063755	-	-	40	1,42	0,71	-	21,30
62333508	0.50x50	■	8002929011213	-	-	48	1,35	0,68	-	33,75
62335507	0.80x50	■	8002929011220	-	-	28	1,35	1,08	-	54,00
62345308	1.00x30	■	8002929036872	-	-	40	1,42	1,42	-	42,60
62345302	1.00x30	■	8002929047793	-	-	40	1,44	1,44	-	43,20
62451305	1.00x30	■	8002929041401	-	-	40	1,42	1,42	-	42,60
62345301	1.00x30	□	8002929036902	-	-	40	1,42	1,42	-	42,60
1A050287	1.00x30	■	8002929072917	-	-	40	1,42	1,42	-	42,60
62345508	1.00x50	■	8002929011251	-	-	24	1,35	1,35	-	67,50
62345502	1.00x50	■	8002929054975	-	-	24	1,37	1,37	-	68,50
62345505	1.00x50	■	8002929011244	-	-	24	1,35	1,35	-	67,50
62345501	1.00x50	□	8002929011237	-	-	24	1,35	1,35	-	67,50
62352507	1.20x50	■	8002929011282	-	-	12	1,35	1,62	-	81,00
1A170232	1.50x50	■	8002929123350	-	-	12	1,35	2,03	-	101,25
1A170233	1.50x50	■	8002929123367	-	-	12	1,37	2,06	-	102,75
1A170234	1.50x50	■	8002929123374	-	-	12	1,35	2,03	-	101,25

Up to 1.50 m TENAX exclusive!



Con contimetri  
With meter counter  
Avec compteurs métriques  
Con cinta métrica  
Mit Meterzähler

 **QUADRA 20**

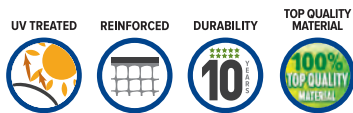

Since 1968 - The original

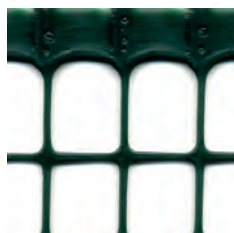

20x20 mm



**Ideale per cancelli.**

A maglia ampia, è ideale come protezione aggiuntiva su cancelli e recinzioni. Rifinita con cimosa da entrambi i lati.

**Ideal for gates.**

The larger mesh size is ideal as additional protection on gates or as a border fence for flowerbeds, ponds, playground areas. With a selvage finish on both sides.

**Idéal pour les grilles.**

















À maille ample, il est idéal comme grillage de protection additionnel sur portails et clôtures. Fini avec lisière des deux côtés.

**Ideal para vallas.**

Malla de luz amplia ideal como protección para cercados y vallas. Acabada con bordes no cortantes en ambos lados.

**Ideal für Tore.**

Die größere Maschenweite ist ideal als zusätzlicher Schutz an Toren und Zäunen. Mit einem Saum an beiden Seiten.

Cod.	m	-	EAN	N° x 	 x 	 x 	€ m <sup>2</sup>	€ m	€  	€  
72170218	0.50x5		8002929035660	12	24	-	-	-	8,55	102,60
1A100315	1.00x3		8002929093554	6	24	-	-	-	9,15	54,90
72170118	1.00x5		8002929035653	6	24	-	-	-	13,52	81,12
1A100316	1.00x5		8002929093561	6	24	-	-	-	13,79	82,74
1A140411	1.00x5		8002929114518	6	24	-	-	-	13,52	81,12
										
62451307	1.00x30		8002929041395	-	-	16	1,52	1,52	-	45,60
62351507	1.00x50		8002929011275	-	-	20	1,45	1,45	-	72,50



Con contametri  
With meter counter  
Avec compteurs métriques  
Con cinta métrica  
Mit Meterzähler

QUADRA 10



QUADRA 20



# CUADRADA 05



1

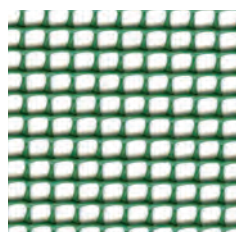

6x5 mm



**Perfetta per terrazze e balconi.**

Rete a maglia quadrata a fili sovrapposti, per un effetto estetico differente. Non presenta rinforzo lungo i bordi. Si può tagliare a misura e si installa facilmente.

**Perfect for terraces and balconies.**

Square mesh made up with overlapping filaments to create a wavy decorative effect. It has not reinforced edges. Easy to cut to size and install.

**Parfait pour les terrasses et les balcon.**

Maille carrée aux fils superposés pour un effet esthétique différent. Il ne possède pas de renforcement le long des bords. Facile à installer. Peut être aisément coupée selon les besoins.

**Perfecta para terrazas y balcones.**

Malla cuadrada con hilos superpuestos que crean un efecto estético diferente. No presenta refuerzo a lo largo de los bordes. Se puede cortar a medida y se instala fácilmente.

**Perfekt für Terrassen und Balkone.**

Viereckige Gitternetze hergestellt aus überlappenden Fäden, die eine besondere ästhetische Wirkung erzeugen. Verfügt über keine Verstärkung entlang der Ränder und können daher auf die Bedürfnisse des Benutzers zugeschnitten und einfach eingebaut werden.

Cod.	m	-	EAN	N° x	x	x	€ m²	€ m	€	€
1A120332	1.00x5		8002929104595	6	24	-	-	-	14,45	86,70
1A150429	1.00x5		8002929118080	6	24	-	-	-	14,74	88,44
1A150431	1.00x5		8002929118097	6	24	-	-	-	14,45	86,70
1A120333	1.00x5		8002929104601	6	24	-	-	-	14,45	86,70
● 1A040033	1.00x25		8002929090522	-	-	18	1,81	1,81	-	45,25
● 1A150425	1.00x25		8002929118042	-	-	18	1,83	1,83	-	45,75
● 1A150426	1.00x25		8002929118059	-	-	18	1,81	1,81	-	45,25
● 1A040032	1.00x25		8002929090515	-	-	18	1,81	1,81	-	45,25



Con contometri  
With meter counter  
Avec compteurs métriques  
Con cinta métrica  
Mit Meterzähler



Fascette in plastica incluse.  
Plastic ties included.  
Liens en plastique inclus.  
Incluye bridas.  
Inklusive Kabelbinder.





# CUADRADA 10

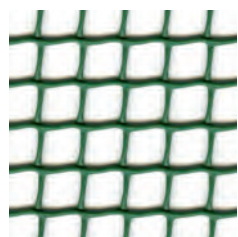

11x10 mm



## Rete decorativa a maglia intermedia.

La maglia di ampiezza 10 mm è la più diffusa ed utilizzata: su balconi, su ringhiere o su recinzioni.

## Decorative net with intermediate mesh.

With mesh sizing 11x10 mm it is the most popular and widely-used. Suitable for use on balconies, on railings and on fences.

## Filet décoratif à maille intermédiaire.

Maille traditionnelle 11x10 mm, elle est la plus vendue et la plus utilisée sur les balcons, les clôtures ou les rampes.

## Malla decorativa con luz de malla intermedia.

La malla decorativa de más venta, utilizada en balcones, cercados y barandillas.

## Dekoratives Gitter mit mittelgroßen Maschen.

Das sehr beliebte und am meisten benutzte Gitter mit 10 mm Maschenweite. Geeignet für Balkone, Zäunen und an Geländern.

Cod.	m	-	EAN	N° x	x	x	€ m <sup>2</sup>	€ m	€	€
1A120334	1.00x5		8002929104618	6	14	-	-	-	14,45	86,70
1A150433	1.00x5		8002929118103	6	14	-	-	-	14,74	88,44
1A150435	1.00x5		8002929118110	6	14	-	-	-	14,45	86,70
1A120335	1.00x5		8002929104625	6	14	-	-	-	14,45	86,70



	1A040035	1.00x25		8002929090539	-	-	14	1,81	1,81	-	45,25
	1A150427	1.00x25		8002929118066	-	-	14	1,83	1,83	-	45,75
	1A150428	1.00x25		8002929118073	-	-	14	1,81	1,81	-	45,25
	1A040034	1.00x25		8002929090560	-	-	14	1,81	1,81	-	45,25



Con contametri  
With meter counter  
Avec compteurs métriques  
Con cinta métrica  
Mit Meterzähler



Fascette in plastica incluse.  
Plastic ties included.  
Liens en plastique inclus.  
Incluye bridas.  
Inklusive Kabelbinder.

# CUADRADA 20

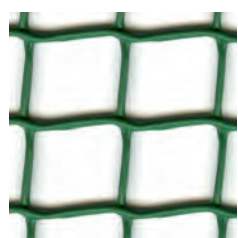

25x20 mm



## Protezione aggiuntiva a maglia larga.

Utilizzata anche in giardino, quale protezione aggiuntiva su recinzioni esistenti.

## Additional protection with wide mesh.

Cuadrada 20 can also be used in the garden as additional protection to existing fences.

## Protection supplémentaire à maille large.

Cette maille peut être utilisée dans le jardin comme protection supplémentaire sur les clôtures existantes.

## Protección adicional con luz de malla amplia.

Se puede emplear también en el jardín como protección adicional para cercados.

## Zusätzlicher Schutz mit breiten Maschen.

Cuadrada 20 kann auch im Garten verwendet werden. Dies bietet einen zusätzlichen Schutz für bestehende Zäune.

Cod.	m	-	EAN	N° x	x	x	€ m <sup>2</sup>	€ m	€	€
1A120336	1.00x5		8002929104632	6	14	-	-	-	14,45	86,70
1A120337	1.00x5		8002929104649	6	14	-	-	-	14,45	86,70



	1A040037	1.00x25		8002929090553	-	-	24	1,81	1,81	-	45,25
	1A040036	1.00x25		8002929090546	-	-	24	1,81	1,81	-	45,25



Con contametri  
With meter counter  
Avec compteurs métriques  
Con cinta métrica  
Mit Meterzähler



Fascette in plastica incluse.  
Plastic ties included.  
Liens en plastique inclus.  
Incluye bridas.  
Inklusive Kabelbinder.

**EXAGON**

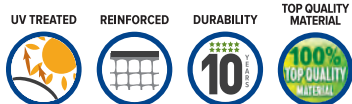

1



30x30 mm



**La maglia esagonale.**

Con bordi rinforzati e non taglianti, Exagon viene applicata su balconi, recinzioni o cancellate come rete protettiva.

**The hexagonal mesh.**

With its reinforced and unsharp edges, Exagon is used on fences and gates also as a protective mesh.

**La maille hexagonale.**

Aux bords renforcés et arasés, peut être appliquée sur les balcons, les clôtures et les portails comme filet de protection.

**Malla hexagonal.**

Con refuerzos no cortantes en los bordes, Exagon se instala en vallados o cercados como malla de protección.

**Das sechseckige Gitter.**

Mit den verstärkten und glatten Kanten wird Exagon auch an Zäunen und Toren als Schutzgitter verwendet.

Cod.	m	-	EAN	N° x	x	x	€ m <sup>2</sup>	€ m	€	€
72040218	0.50x5		8002929000491	12	24	-	-	-	8,55	102,60
1A100285	0.50x5		8002929093349	12	24	-	-	-	8,72	104,64
72040118	1.00x5		8002929000385	6	24	-	-	-	13,52	81,12
72040112	1.00x5		8002929047779	6	24	-	-	-	13,79	82,74



	61005308	0.50x30		8002929037091	-	-	64	1,60	0,80	-	24,00
	61405508	0.50x50		8002929010698	-	-	40	1,52	0,76	-	38,00
	61406508	0.60x50		8002929010728	-	-	30	1,52	0,91	-	45,60
	61408508	0.80x50		8002929010735	-	-	23	1,52	1,22	-	60,80
	61010308	1.00x30		8002929037107	-	-	16	1,60	1,60	-	48,00
	61010302	1.00x30		8002929047786	-	-	32	1,62	1,62	-	48,60
	61410508	1.00x50		8002929010766	-	-	20	1,52	1,52	-	76,00
	61412508	1.20x50		8002929010797	-	-	15	1,52	1,82	-	91,20



Con contametri  
With meter counter  
Avec compteurs métriques  
Con cinta métrica  
Mit Meterzähler

**EXAGON**



**MISTRAL**

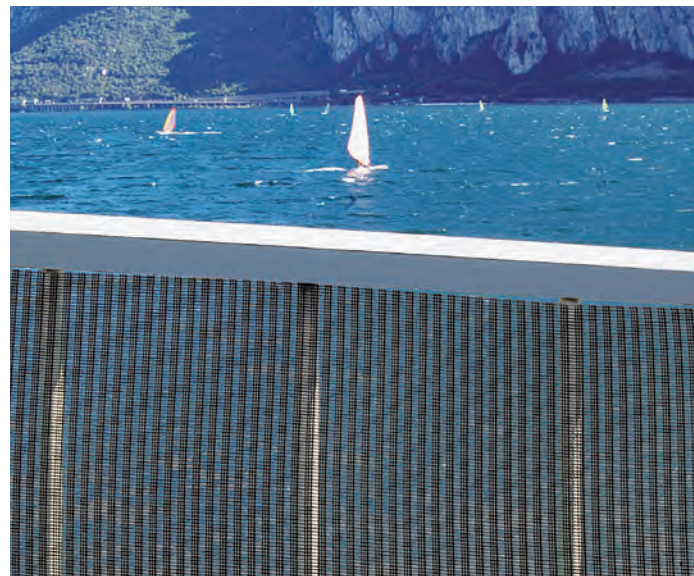

IR AIRY

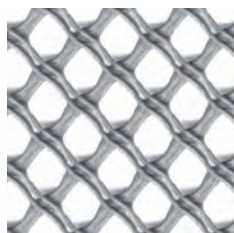

13x12 mm



**Decorativa e frangivista.**

A maglia romboidale piccola e arrotondata, abbellisce terrazze e giardini, schermandoli alla vista e dal vento.

**Decorative windbreak.**

Designed with a small rounded mesh, recommended on balconies, patios and terraces to protect from wind as well as decorate by giving a uniform look to spaces.

**Le filet décoratif contre le vent.**

Une maille de petite taille, arrondie et rhomboïdale qui embellit les terrasses et les jardins, tout en les protégeant du vent et de la vue.

**La malla decorativa cortaviento.**

Malla romboidal pequeña y redondeada para decorar terrazas y jardines, a la vez que oculta y protege del viento.

**Das dekorative Netz als Windschutz.**

Mit kleinen runden Öffnungen, wurde Airy entworfen, um einen dekorativen Windschutz an Balkonen, in Vorgärten und Terrassen zu bieten.

Cod.	m	-	EAN	N° x	x	x	€ m <sup>2</sup>	€ m	€	€
72500116	1.00x5		8002929059550	6	24	-	-	-	15,55	93,30
1A100283	1.00x5		8002929093332	6	24	-	-	-	15,86	95,16
59091308	1.00x30		8002929059659	-	-	12	2,78	2,78	-	83,40
1A150278	1.00x30		8002929116918	-	-	12	2,80	2,80	-	84,00



Con contametri  
With meter counter  
Avec compteurs métriques  
Con cinta métrica  
Mit Meterzähler

IR MISTRAL

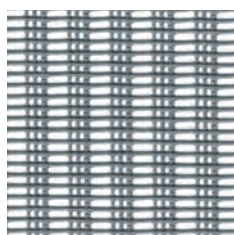

11x3 mm



**Rete decorativa frangivento.**

La particolare struttura della rete, che alterna due differenti maglie rettangolari, crea un disegno originale, particolarmente indicato per schermare dal vento.

**Decorative windbreak.**

The structure of the net, that combines two different rectangular meshes, creates an original pattern which offers resistance to wind, when used on gates and railings.

**La délimitation décoratif brise vent.**

La structure unique de ce filet combine deux mailles rectangulaires différentes. Ce design original est particulièrement adapté pour atténuer l'intensité du vent.

**La ocultación decorativa cortaviento.**

Su especial estructura, que combina dos mallas rectangulares diferentes, crea un dibujo original que filtra y atenúa la intensidad del viento.

**Der dekorative Windschutznetz.**

Dieses Produkt wurde speziell aus zwei verschiedenen rechteckige Maschen entworfen um so ein engmaschiges Gitter gegen starke Winde zu erhalten.

Cod.	m	-	EAN	N° x	x	x	€ m <sup>2</sup>	€ m	€	€
72130118	1.00x5		8002929000576	6	24	-	-	-	16,58	99,48
1A100297	1.00x5		8002929093417	6	24	-	-	-	16,91	101,46
63610308	1.00x30		8002929038166	-	-	20	3,00	3,00	-	90,00
1A150279	1.00x30		8002929116925	-	-	20	3,02	3,02	-	90,60



Con contametri  
With meter counter  
Avec compteurs métriques  
Con cinta métrica  
Mit Meterzähler

 **TRIPLET**



1

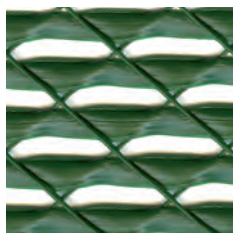

**Nuovo disegno a tre fili.**

Una rete dalla struttura originale, composta da tre fili di diversa forma. Resistente e schermante, ideale per mitigare il vento e proteggere dalla vista.

**New mesh design with three threads.**

Highly decorative mesh thanks to its structure, made up of three filaments of different shapes and sizes. Highly resistant and screening, it mitigates the effect of the wind. It screens also from view.

**Nouveau design à trois fils.**











Filet plastique très décoratif grâce à sa structure originale, composé de trois fils de formes et de tailles différentes. Très résistant et occultant, il atténue l'effet du vent et il protège également de la vue.

**Nuevo diseño con tres hilos.**

Malla plástica muy decorativa gracias a su original diseño, compuesta por tres hilos de diferente forma. Resistente y de ocultación media, ideal para proteger del viento balcones y terrazas.

**Dreisträngiges Gitter.**

Ein sehr dekoratives Kunststoffnetz mit einer ursprünglichen Struktur, hergestellt aus drei Strängen. Beständig und bietet Standardschutz. Ideal um die Wirkung von Wind auf Balkonen und Terrassen abzumildern.

Cod.	m	-	EAN	N° x 	 x 	 x 	€ m <sup>2</sup>	€ m	€ 	€ 	€ 
1A120338	1.00x3		8002929104656	6	24	-	-	-	16,38	98,28	
											
1A120339	1.00x25		8002929104663	-	-	24	3,72	3,72	-	93,00	

**TRIPLET**



**HOBBY 30**

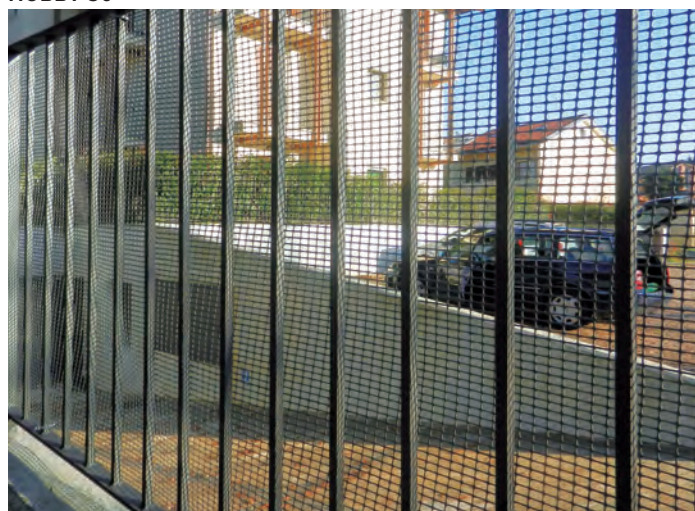

**HOBBY 10**

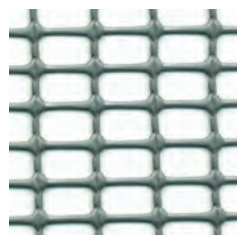

15x10 mm



**La recinzione a maglia stretta.**

Particolarmente resistente, grazie al processo di orientamento dei fili longitudinali, è ideale come protezione aggiuntiva su recinzioni e cancellate.

**The fence with tight mesh.**

Highly resistant, thanks to the special process orientation of the threads during production. Recommended use in combination with existing railings and gates for additional protection.

**La clôture à maille étroite.**

Particulièrement résistante, grâce au processus d'orientation des fils longitudinaux, elle est idéale comme protection supplémentaire sur les clôtures et les portails.

**El cercado con luz de malla reducida.**

Especialmente resistente gracias al proceso de orientación de los hilos longitudinales, es ideal como protección adicional en cercas y vallas.

**Die Umzäunung mit engen Maschen.**

Dank des Orientierungsprozesses der Längsfäden besonders widerstandsfähiges Netz, ideal als zusätzlicher Schutz an Zäunen und Toren.

Cod.	m	-	EAN	N° x	x	x	€ m <sup>2</sup>	€ m	€	€
72110118	1.00x5		8002929035714	6	24	-	-	-	13,52	81,12
72110116	1.00x5		8002929050250	6	24	-	-	-	13,79	82,74
63410506	1.00x50		8002929011367	-	-	24	1,74	1,74	-	87,00

Resistente grazie al processo di stiro – Resistant thanks to the stretching process – Résistants grâce au processus d'étirage – Resistente gracias al proceso de estirado – Widerstandsfähig dank des Dehnprozesses

**HOBBY 30**

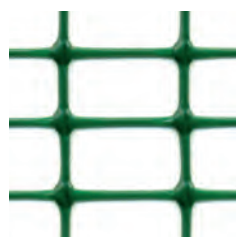

32x20 mm



**Extra resistente.**

È disponibile anche in altezza 50 cm, come bordura o delimitazione per giardino e orto.

**Extra resistant.**

Also available in rolls 50 cm high, as a boundary or to fence off a garden or a vegetable plot.

**Extra résistant.**

Elle est également disponible en hauteur de 50 cm, comme bordure ou délimitation du jardin et du potager.

**Extra resistente.**

Disponibile también en altura 50 cm como bordura o delimitador en el jardín o el huerto.

**Besonders widerstandsfähig.**

Auch verfügbar in 50 cm Höhe, als Abgrenzung oder um einen Garten oder ein Gemüsebeet zu umzäunen.

Cod.	m	-	EAN	N° x	x	x	€ m <sup>2</sup>	€ m	€	€
72060218	0.50x5		8002929000484	12	24	-	-	-	8,55	102,60
72060118	1.00x5		8002929000422	6	24	-	-	-	13,52	81,12
63510506	1.00x50		8002929011381	-	-	24	1,74	1,74	-	87,00

Resistente grazie al processo di stiro – Resistant thanks to the stretching process – Résistants grâce au processus d'étirage – Resistente gracias al proceso de estirado – Widerstandsfähig dank des Dehnprozesses

**L'esclusivo processo di biorientamento molecolare ("stiro") TENAX**

Frutto dell'expertise Tenax nella realizzazione delle reti in plastica, l'esclusivo processo di biorientamento molecolare nelle due direzioni permette di conferire alle reti Tenax caratteristiche di resistenza alla trazione, allo sfondamento ed allo strappo davvero uniche.

**MILLENNIUM, RANCH** ma anche le più leggere **CINTOFLEX, AVIARY** e **S38** hanno delle caratteristiche meccaniche eccezionali che le avvicinano alle performance delle reti in metallo ma con tutti i vantaggi della plastica (leggerezza, resistenza alla ruggine ed a qualsiasi condizione atmosferica, facilità d'installazione). Per **MILLENNIUM** e **RANCH** sono disponibili tutorial dedicati che spiegano come realizzare al meglio le recinzioni.

**The exclusive process of molecular bi-orientation ("stretching") by TENAX**

The result of Tenax expertise in plastic nets is the exclusive process of molecular bi-orientation in both directions that provides Tenax nets with unique tensile strength, break-through and tear resistance.

**MILLENNIUM, RANCH** as well as the lighter **CINTOFLEX, AVIARY** and **S38** have exceptional mechanical characteristics with performance similar to metal nets, but with all the advantages of plastic (they are light, resistant to rust and weather elements, and easy to install). There are also very interesting tutorials which explain how to build private fences with **MILLENNIUM** and **RANCH**.

**Le processus exclusif de bi-orientation moléculaire ("étirage") TENAX**

Fruit de l'expertise de Tenax dans la production de filets en plastique, le processus exclusif de Bi-Orientation moléculaire dans les deux sens permet de donner aux filets Tenax des caractéristiques de résistance à la traction, à la perforation et au déchirement vraiment uniques.

**MILLENNIUM, RANCH**, mais aussi les plus légères **CINTOFLEX, AVIARY** et **S38** ont des caractéristiques mécaniques exceptionnelles qui les rapprochent aux performances des filets métalliques mais avec tous les avantages du plastique (légèreté, résistance à la rouille et aux conditions climatiques, facilité d'installation). **MILLENNIUM** et **RANCH** ont aussi des tutoriels intéressants expliquant comment réaliser des clôtures privées.

**El exclusivo proceso de biorientación molecular ("stiro") TENAX**

Fruto de la competencia Tenax en la realización de mallas de plástico, el exclusivo proceso de biorientación molecular en las dos direcciones permite atribuir a las mallas Tenax características de resistencia a la tracción, al hundimiento y a la rotura realmente únicas.

**MILLENNIUM, RANCH** y también las más ligeras **CINTOFLEX, AVIARY** y **S38** poseen características mecánicas excepcionales que las acercan a la función de las mallas de metal pero con todas las ventajas del plástico (ligereza, resistencia a la corrosión y a cualquier condición atmosférica, facilidad de instalación). **MILLENNIUM** y **RANCH** tienen también interesantísimos tutoriales que explican cómo realizar cercados privados.

**Das exklusive Verfahren der molekularen Biorientierung ("Streckung") TENAX**

Das exklusive Verfahren der molekularen Biorientierung in beide Richtungen, Ergebnis der Tenax Expertise in der Erstellung der Kunststoffnetze, erlaubt es den Tenax Netzen wirklich einmalige Eigenschaften von Zug-, Durchbruch und Reißfestigkeit zu verleihen.

**MILLENNIUM, RANCH** aber auch die leichteren **CINTOFLEX, AVIARY** und **S38** haben außerordentliche mechanische Eigenschaften die sich den Leistungen von Metallnetzen nähern, allerdings mit allen Vorteilen des Kunststoffs (Leichtigkeit, Beständigkeit gegen Rost und jeglichen Witterungseinfluss, einfache Anbringung). **MILLENNIUM** und **RANCH** haben auch sehr interessante Tutorials die erklären wie man private Einzäunungen verwirklichen kann.

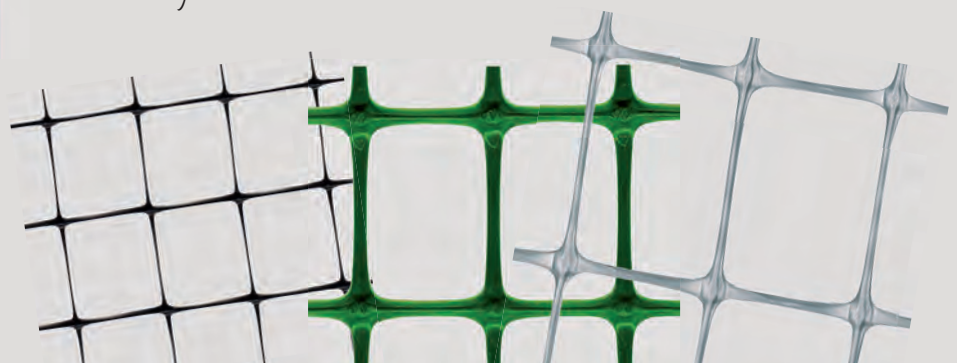
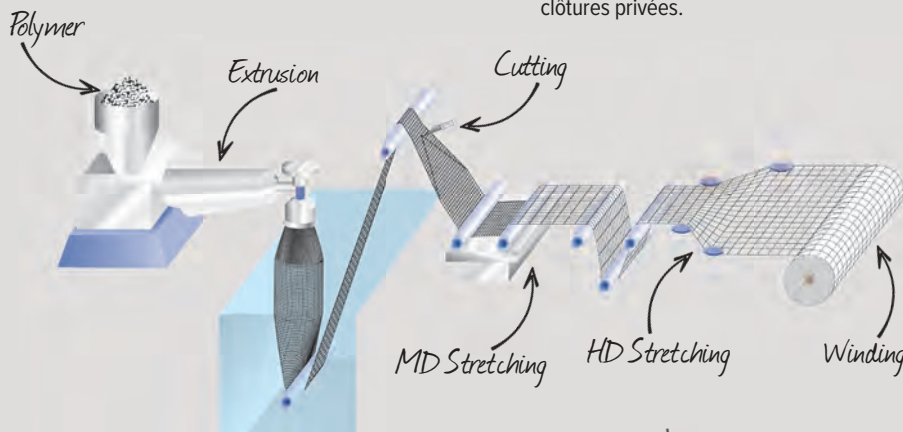



### Recinzioni in plastica

Facilità di posa in opera, leggerezza di trasporto, inalterabilità agli agenti atmosferici, le rendono perfette come recinzioni permanenti. Una vasta gamma di accessori, i video tutorial e le istruzioni sulla confezione, guidano il consumatore in una perfetta installazione.

### Plastic fences

TENAX bioriented meshes are cost effective, easy to handle and use, durable and perfect for permanent fencing. A wide range of accessories combined with tutorials and label instructions will guide the user during installation.

### Clôtures en plastique

Filets en plastique extrêmement résistants, recommandés pour les clôtures permanentes. Disponibles avec des fils plus lourds pour les clôtures résidentielles ou des fils plus légers pour créer des volières et des enclos pour les animaux de basse-cour.

### Cercas de plástico

Mallas de plástico particularmente resistentes para cercados permanentes. Disponibles con hilos más gruesos para cercados residenciales o con hilos más ligeros para la creación de recintos para animales de corral.

### Kunststoff-umzäunungen

Die TENAX Kunststoffzäune aus Polypropylen durchlaufen ein spezielles Verfahren der molekularen Orientierung der Fäden in zwei Richtungen, um die Weiterreißkraft und die Zugfestigkeit weiter zu erhöhen.

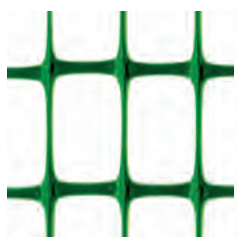

30x45 mm



#### La recinzione forte e pratica.

La maglia presenta fili piatti e leggeri, ma con elevata resistenza. Ideale come delimitazione di recinti per animali e come recinzione permanente di aree verdi, giardini e impianti sportivi.

#### The strong and practical fence.

The mesh has flat and light threads, though maintaining its high strength. Ideal to fence courtyard animals and as a permanent fence in green areas, gardens and sports facilities.

#### La clôture solide et pratique.

La maille composée de fils plats et légers assure malgré tout une très haute résistance. Idéale comme délimitation pour les enclos des animaux et comme clôture permanente pour les espaces verts, les jardins et les terrains de sport.

#### El cercado fuerte y práctico.

La malla presenta hilos planos y ligeros, aunque mantiene una elevada resistencia. Se utiliza para cercar recintos para animales o como cercado permanente de jardines, instalaciones deportivas y zonas verdes en general.

#### Die starke und praktische Umzäunung.

Netz mit flacheren und leichteren Fäden, obwohl seine hohe Festigkeit beibehalten wird. Ideal für die Umzäunung von Hofftieren und als permanenter Zaun in Grünflächen, Gärten und Sportanlagen.

Cod.	m	-	EAN	N° x	x	x	€ m <sup>2</sup>	€ m	€	€
1A130305	1.00x10		8002929109859	6	24	-	-	-	18,25	109,50
1A130306	1.50x10		8002929109866	6	12	-	-	-	27,49	164,94
93080806	1.00x50		8002929034816	-	-	50	1,61	1,61	-	80,50
93081506	1.50x50		8002929034809	-	-	30	1,61	2,42	-	120,75
93082006	2.00x50		8002929034830	-	-	30	1,61	3,22	-	161,00
93088006	4.00x50		8002929034854	-	-	-	1,61	6,44	-	322,00

**MILLENNIUM**



1



35x48 mm



**Resistente come il metallo.**  
Ideale come recinzione residenziale permanente, soprattutto nelle zone di mare, poiché inerte alla corrosione salina.

**As strong as metal.**  
Ideal for permanent residential fencing, especially recommended in seaside areas because it is not affected by saline corrosion.

**Résistant comme le métal.**  
Idéal comme clôture résidentielle permanente, en particulier dans les lieux maritimes, puisqu'il est inerte à la corrosion saline.

**Resistente como el metal.**  
Es ideal para instalarla en cercados residenciales permanentes, sobre todo en las zonas de mar, puesto que es resistente a la corrosión salina.

**So beständig wie Metall.**  
Ideal als permanente Einzäunung für Häuser, insbesondere in Küstengebieten: Er wird nicht durch Salz-Korrosion beeinträchtigt.

Cod.	m	-	EAN	N° x	x	x	€ m <sup>2</sup>	€ m	€	€
------	---	---	-----	------	---	---	------------------	-----	---	---

1A140412	1.00x10	■	8002929114525	4	9	-	-	-	23,12	92,48
72250132	1.00x10	■	8002929054692	4	9	-	-	-	23,12	92,48
1A150013	1.00x10	■	8002929114662	4	9	-	-	-	23,12	92,48
1A130469	1.00x25	■	8002929111180	-	-	13	2,13	2,13	-	53,25
1A130229	1.00x25	■	8002929109200	-	-	13	2,13	2,13	-	53,25
1A150010	1.00x25	■	8002929114648	-	-	13	2,13	2,13	-	53,25
1A130363	1.20x10	■	8002929110404	4	6	-	-	-	27,46	109,84
1A130468	1.20x25	■	8002929111173	-	-	13	2,13	2,56	-	63,90
1A150009	1.50x10	■	8002929114631	4	9	-	-	-	34,65	138,60
1A130307	1.50x10	■	8002929109873	4	9	-	-	-	34,65	138,60
1A150014	1.50x10	■	8002929114679	4	9	-	-	-	34,65	138,60
1A150008	1.50x25	■	8002929114624	-	-	13	2,13	3,20	-	79,88
1A130235	1.50x25	■	8002929109262	-	-	16	2,13	3,20	-	79,88
1A150011	1.50x25	■	8002929114655	-	-	16	2,13	3,20	-	79,88



60910252	1.00x50	■	8002929046840	-	-	20	2,03	2,03	-	101,50
60920252	2.00x50	■	8002929046857	-	-	10	2,03	4,06	-	203,00
60940252	4.00x50	■	8002929046864	-	-	-	2,03	8,12	-	406,00



PLASTIC FENCES  
Tutorial for  
PROFESSIONAL



PLASTIC FENCES  
Tutorial for DIY

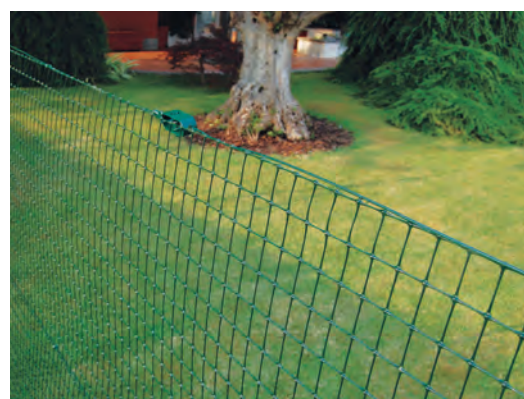
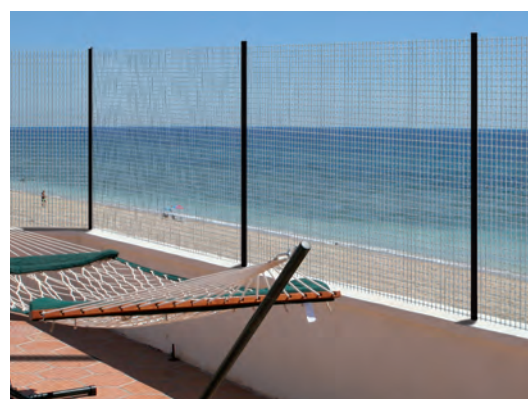



# ITALY C-FLEX



45x50 mm

**La rete anti-cervo più venduta in US.**  
Rete da recinzione per proteggere con grande efficacia, dai danni causati dai cervi, senza nuocere agli animali. Il trattamento anti-UV permette di mantenere il colore e le caratteristiche inalterate nel tempo. La struttura a filo tondo è l'originale caratteristica di TENAX C-FLEX. Risulta invisibile nelle aree ombreggiate o boscoso.

**The best-selling deer fence in the USA.**  
A permanent barrier for enclosing areas which need protection from deer damages. It is UV treated, so it keeps colour and features unaltered over time. Its round thread structure is an original feature of TENAX C-FLEX. It is virtually invisible in shady areas or woods.

**Le filet anti-cerf le plus vendu aux USA.**  
Une barrière permanente pour délimiter les zones qui ont besoin de protection contre les dommages causés par les cerfs. Le traitement anti UV maintient la couleur et la stabilité au fil du temps. La structure à fil rond est la caractéristique originale de TENAX C-FLEX. Il apparaît invisible dans les zones ombragées ou boisées.

**La malla anticiervos más vendida en EE.UU.**  
Mallas para cercados extremadamente fuertes y resistentes. Protegen con gran eficacia contra los daños causados por los ciervos sin ser nocivas para estos animales. El tratamiento anti-UV permite mantener el color y las características inalteradas en el tiempo. La estructura con hilo redondo es la original característica de TENAX C-FLEX. Resulta invisible en las zonas de sombra o boscosas.

**Das meistverkaufte Anti-Wild Gitter in den USA.**  
Eine dauerhafte Einzäunung um entsprechende Bereiche gegen Wildschäden zu schützen. Dank der Anti-UV Behandlung bleiben die Farbe und die Eigenschaften mit der Zeit unverändert. Die Struktur mit rundem Faden ist die originale Eigenschaft von TENAX C-FLEX. Unsichtbar in schattigen oder waldigen Bereichen.

Cod.	m	-	EAN	N° x	x	x	€ m <sup>2</sup>	€ m	€	€
60097409	1.80x100	■	8002929010094	-	-	16	1,12	2,02	-	201,60
60098409	2.30x100	■	8002929010100	-	-	-	1,12	2,58	-	257,60
60099409	3.00x100	■	8002929010117	-	-	-	1,12	3,36	-	336,00

# ITALY CINTOFLEX C

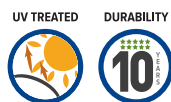

45x50 mm

**Flessibile ma resistente.**  
Si utilizza negli impianti sportivi.

**Flexible but strong.**  
It is perfect for playing fields.

**Flexible et résistante.**  
Pour les installations sportives.

**Flexible y resistente.**  
Se utiliza para instalaciones deportivas.

**Flexibel, aber stark.**  
Es perfekt für Spiel- und Sportflächen.

Cod.	m	-	EAN	N° x	x	x	€ m <sup>2</sup>	€ m	€	€
60008409	3.00x100	■	8002929009739	-	-	-	1,02	3,06	-	306,00
60009409	4.60x100	■	8002929009746	-	-	-	1,02	4,69	-	469,20

## C-FLEX

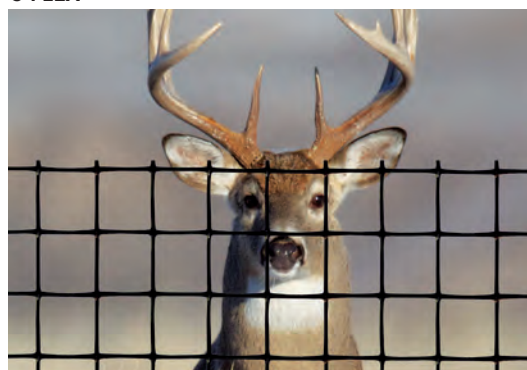

## CINTOFLEX C



## 1 CINTOFLEX D



22x35 mm

**Per gli animali da cortile.**  
Maglia ampia per recinti di animali domestici e da cortile.

**For courtyard animals.**  
A wide mesh to create fences for small domestic and courtyard animals.

**Pour les animaux de ferme.**  
Maille large pour la création de barrières ou d'enclos pour les petits animaux et les volailles.

**Para animales de corral.**  
Malla de luz amplia ideal para construir recintos para animales domésticos y de corral.

**Für Kleintiere.**  
Mit seiner großen Masche wird hauptsächlich zum Bauen von Zäune für kleine Haustiere und Hoftiere verwendet.

Cod.	m	-	EAN	N° x	x	x	€ m <sup>2</sup>	€ m	€	€
60010409	1.00x100	■	8002929009760	-	-	28	1,02	1,02	-	102,00
60015409	1.50x100	■	8002929009784	-	-	-	1,02	1,53	-	153,00
60020409	2.00x100	■	8002929009791	-	-	-	1,02	2,04	-	204,00
60025409	3.00x100	■	8002929009807	-	-	-	1,02	3,06	-	306,00
60030409	4.60x100	■	8002929009814	-	-	-	1,02	4,69	-	469,20

## 1 CINTOFLEX M



18x25 mm



**Best seller nelle recinzioni avicole.**  
È utilizzata principalmente per costruire gabbie per uccellini e per recinti di pollame.

**Best seller for bird fencing.**  
It is mainly used to build small bird cages and chicken runs.

**Meilleures ventes dans les clôtures pour volailles.**  
Elle est utilisée pour la construction de cages pour petits oiseaux et pour les enclos à volailles.

**Best seller de los cercados avícolas.**  
Se utiliza principalmente para construir jaulas para aves y para gallineros.

**Bestseller bei Umzäunungen zur Geflügelzucht.**  
Es wird hauptsächlich benutzt um kleine Vogelkäfige und Ausläufe für Hühner zu bauen.

Cod.	m	-	EAN	N° x	x	x	€ m <sup>2</sup>	€ m	€	€
72100149	1.00x10	■	8002929000361	6	24	-	-	-	12,88	77,28
60040409	1.00x100	■	8002929009869	-	-	28	1,02	1,02	-	102,00
60045409	1.50x100	■	8002929009982	-	-	16	1,02	1,53	-	153,00
60050409	2.00x100	■	8002929010001	-	-	-	1,02	2,04	-	204,00
60065409	4.60x100	■	8002929010018	-	-	-	1,02	4,69	-	469,20



# INTOFLEX E



13x15 mm

**Perfetta per le voliere.**  
La maglia di ampiezza ridotta è indicata per la creazione di voliere per piccoli uccelli e per molte altre applicazioni.

**Perfect for aviaries.**  
With its smaller mesh, it can be used to create aviaries for small birds and for many other applications.

**Parfait pour les volières.**  
Ce filet à maille réduite est indiqué pour la création de volières pour petits oiseaux mais trouve également son emploi dans de nombreuses autres applications.

**Perfecta para pajareras.**  
Malla de luz reducida, indicada para construir jaulas para pequeños pájaros y para otras muchas aplicaciones.

**Perfekt für Volieren.**  
Mit den kleineren Maschen kann es für den Bau von Käfigen für kleinere Vögel verwendet werden und für viele weitere Anwendungen.

Cod.	m	-	EAN	N° x	x	x	€ m <sup>2</sup>	€ m	€	€
60031409	1.00x100	■	8002929009821	-	-	28	1,02	1,02	-	102,00
60032409	2.00x100	■	8002929009838	-	-	-	1,02	2,04	-	204,00
60038409	4.00x100	■	8002929009852	-	-	-	1,02	4,08	-	408,00

# AVIARY



16x19 mm

**Per coperture avicole e di laghetti.**  
Leggera e flessibile, è specifica per uso in orizzontale in molteplici applicazioni, dalla chiusura di gabbie e pollai (per impedire l'intrusione di altri volatili) alla copertura di laghetti in giardino, per proteggere i pesci dai predatori.

**For covering bird cages and small ponds.**  
Plastic grid mesh, light and flexible, specifically for horizontal use in many applications, from closing cages and chicken runs (to prevent intrusion of other birds or farmed birds escaping) to covering garden ponds, to protect them from leaves in autumn.

**Pour la fermeture des cages pour volailles ou la couverture des étangs.**  
À maille léger et souple il est spécifique pour une utilisation en horizontale dans de multiples applications pouvant aller de la fermeture des cages pour volailles (afin d'empêcher l'intrusion de volailles externes ou la fugue de celles en élevage) à la couverture de bassins de jardin, en guise de protection pour les feuilles d'automne.

**Para protecciones avícolas y de estanques.**  
Malla de plástico, ligera y flexible, es específica para uso horizontal en múltiples aplicaciones: desde el uso en jaulas para aves (para impedir la intrusión de otro pájaros o para evitar que los de crianza escapen), hasta la protección de estanques de jardín, para proteger de las hojas durante el otoño.

**Zur Abdeckung von Geflügel und kleinen Seen.**  
Ein Kunststoffgitter mit einer mittleren Maschengröße, leicht, flexibel und speziell für den horizontalen Einsatz in vielen Anwendungen um Käfige und Ausläufe für Hühner zu schließen (um zu verhindern, dass andere Vögel eindringen oder Zuchtvögel fliehen können). Oder um Gartenteiche zu überspannen und sie im Herbst vor Blättern zu schützen.

Cod.	m	-	EAN	N° x	x	x	€ m <sup>2</sup>	€ m	€	€
1A100064	1.00x10	■	8002929091703	6	24	-	-	-	11,92	71,52
1A160216	2.00x10	■	8002929120472	6	14	-	-	-	18,69	112,14
1A030252	1.00x200	■	8002929064554	-	-	28	0,71	0,71	-	142,00
1A070613	1.50x200	■	8002929083296	-	-	14	0,71	1,07	-	213,00
1A030355	2.00x200	■	8002929065650	-	-	14	0,71	1,42	-	284,00
1A070532	4.00x200	■	8002929082787	-	-	-	0,71	2,84	-	568,00

# LIMIT GARDEN



1



33x65 mm

## Transenna modulare.

Composta da una struttura in ferro zincato e da una rete in plastica. Ideale per recintare temporaneamente aree in sistemazione, spazi di gioco ed eventi. Autoportante e di posa immediata, è lavabile e riutilizzabile infinite volte.

## Modular barrier.

Made of metal and plastic, used in the temporary delimitation of seeded areas, playgrounds or working areas. Self-supporting and very easy to install, washable and reusable. Complementary fixing elements available on demand.

## Barrière modulaire.

Composée d'une structure en fer, couplée à un filet en plastique. Idéale pour les clôtures provisoires de semis, les cours de récréation ou les chantiers. Cette barrière est autoportante, facile à installer, lavable et réutilisable.

## Valla modular.

Compuesta por una estructura de hierro y una malla de plástico. Ideal para cercar de forma temporal áreas sembradas, zonas de obras y espacios para el juego de los niños. Auto sostenible, fácil y rápida de instalar, puede lavarse y reutilizarse.

## Modulare Barriere.

Aus Metall und Kunststoff für die temporäre Abgrenzung von Saatflächen, Spielplätzen oder Arbeitsbereichen. Selbsttragend und sehr einfach aufzustellen, waschbar und wiederverwendbar. Komplementäre Befestigungselemente sind auf Anfrage erhältlich.

Cod.	m	-	EAN	N° x	x	x	€ m²	€ m	€	€
1A080134	1.00x4	■	8002929084521	-	16	-	-	-	-	113,08



## Accessori Accessories Accessoires Accesorios Zubehör

Cod.	m	-	EAN	N° x	x	x	€ m²	€ m	€	€
------	---	---	-----	------	---	---	------	-----	---	---

## PICCHETTO – PICKET – PIQUET – PIQUETE – ERDSPIESS



34926001	0.60	■	8002929040435	-	-	-	-	-	-	4,82
----------	------	---	---------------	---	---	---	---	---	---	------

In ferro verniciato – Made of black painted iron – En fer peint de couleur noir – En hierro barnizado de color negro – Hergestellt aus schwarz lackiertem Eisen

## PIEDINO PIATTO – FLAT FOOT – PLAQUE DE PIED – PIE PLANO – FUSS



34940100	0.17x0.48	■	8002929039668	-	-	-	-	-	-	7,64
----------	-----------	---	---------------	---	---	---	---	---	---	------

In ferro verniciato – Made of black painted iron – En fer peint de couleur noir – En hierro barnizado de color negro – Hergestellt aus schwarz lackiertem Eisen



## Reti in metallo

Comprendono **recinzioni protettive e decorative per i giardini, reti per la costruzione di gabbie, pollai e piccoli recinti nei cortili**. In filo di ferro o di acciaio zincato, vengono plastificate per i prodotti con funzione ornamentale e/o elettrosaldate per le recinzioni più rigide e robuste. Sono invece lavorate a triplice torsione dove è necessaria una maggiore flessibilità della rete.

## Wire meshes

Fences range from **protective and decorative fences for the garden, to the more traditional wire nets for the construction of cages, hen-pens and small enclosures in courtyards**. Made of iron or steel, the thread is coated with plastic for the most decorative products, galvanized for rigid and strong meshes, or worked in triple torsion when greater flexibility is required.

## Filets métalliques

Vaste gamme de mailles métalliques: des **clôtures plus résistantes et décoratives pour les jardins** ou des filets plus traditionnels pour les **cages ou les poulaillers**. En fil de fer galvanisé ou en acier, ils peuvent être recouverts de plastique, soudés électriquement ou à triple torsion. Ces différentes caractéristiques rendent les filets plus décoratifs, plus rigides et résistants ou plus flexibles.

## Mallas metálicas

Mallas más resistentes para **proteger y decorar jardines**, mallas tradicionales para construir **jaulas, gallineros y pequeños cercados en patios y corrales**. El alambre de hierro o acero galvanizado, se plastifica en los productos para decoración; se electro-solda en las vallas más rígidas y resistentes; o se somete a una triple torsión cuando es necesaria una mayor flexibilidad de la malla.

## Drahtgitter

TENAX Metallzäune reichen von schützenden und **dekorativen Zäunen für den Garten** bis zu den traditionellen **Drahtnetzen für den Bau von Käfigen, Hühnerställen und kleinen Boxen in Höfen**. Hergestellt aus Eisen oder Stahl wird der Draht für die meisten dekorative Produkte mit Kunststoff überzogen, verzinkt für steife und starke Gitter oder in Dreifach-Verdrillung für eine größere Flexibilität.

PLASTIC COATED

## PLAMET 10

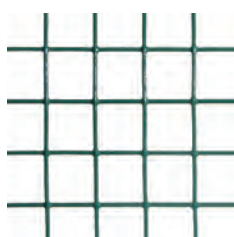

14x14 mm – ø 0.9 mm



### La maglia quadrata plastificata.

In filo di ferro zincato e plastificato, è una rete rigida e può essere applicata su cancellate e recinzioni esistenti quale protezione aggiuntiva.

### Square coated wire mesh.

Galvanized welded wire mesh, finished with plastic coating. It can be installed on existing fencing for additional protection.

### Maille carrée plastifiée.

En fil de fer galvanisé plastifié, c'est un filet solide qui peut être installé sur des clôtures existantes pour plus de protection.

### Malla cuadrada plastificada.

En alambre de hierro galvanizado y plastificado, es una malla resistente que puede aplicarse sobre vallas ya existentes como protección adicional.

### Quadratisches, beschichtetes Drahtgitter.

Verzinktes geschweißtes Drahtgitter mit Kunststoffbeschichtung. Es kann an bestehenden Umzäunungen als zusätzlichen Schutz installiert werden.

Cod.	m	-	EAN	N° x	x	x	€ m <sup>2</sup>	€ m	€	€	
74050400	0.50x5		8002929033857	8	20	-	-	-	13,90	111,20	
74050500	1.00x5		8002929033864	4	20	-	-	-	25,49	101,96	
1A070487	1.00x25		8002929082299	-	-	25	4,20	4,20	-	105,06	

# PLAMET 20

PLASTIC COATED



1



20x20 mm – ø 1.1 mm



## La rete plastificata a maglia ampia.

La maglia più ampia è indicata per costruire piccole recinzioni per animali.

## The plastic-coated, wide mesh net.

Ideal for making small enclosures for animals or to delimit vegetable patches and garden areas.

## Le filet plastifié à maille large.

La maille plus large rend ce filet parfait pour la construction de petits enclos pour les animaux ou pour délimiter le potager du jardin d'agrément.

## La malla plastificada con luz amplia.

Malla de luz más amplia, perfecta para la construcción de pequeños recintos para animales o para delimitar huertos y jardines.

## Das kunststoffbeschichtete Gitter mit breiten Maschen.

Ideal für die Herstellung kleinerer Boxen für Tiere oder um Gemüsebeete und Grünflächen einzuzugrenzen.

Cod.	m	-	EAN	N° x	x	x	€ m <sup>2</sup>	€ m	€	€
------	---	---	-----	------	---	---	------------------	-----	---	---

74060400	0.50x5	■	8002929033871	8	16	-	-	-	13,90	111,20
74060300	1.00x5	■	8002929033888	4	16	-	-	-	25,49	101,96

# QUADRAMET 10

NO-CORROSION



14x14 mm – ø 0.8 mm



## La maglia quadrata zincata.

In filo di ferro zincato ed elettrosaldato, è perfetta per costruire gabbie e recinzioni per piccoli animali.

## Square galvanized mesh.

Welded and galvanized wire mesh, ideal for animal fences, pet runs and open-air bird cages.

## Maille carrée galvanisée.

En fil de fer galvanisé et soudé électriquement: parfait pour les barrières et les cages en plein air.

## Malla cuadrada galvanizada.

En alambre de hierro galvanizado y electro-soldado, es ideal para construir jaulas y recintos al aire libre.

## Quadratisches verzinktes Gitter.

Verschweißtes und verzinktes Gitter, ideal für Tierzäune, Ausläufe für Haustiere und Vogelkäfige.

Cod.	m	-	EAN	N° x	x	x	€ m <sup>2</sup>	€ m	€	€
------	---	---	-----	------	---	---	------------------	-----	---	---

74030400	0.50x5	■	8002929035882	8	16	-	-	-	13,90	111,20
74030500	1.00x5	■	8002929033833	4	16	-	-	-	25,49	101,96

# QUADRAMET 20

NO-CORROSION



20x20 mm – ø 0.8 mm



## Zincata a maglia grande.

Nella maglia più ampia, è indicata anche per delimitare spazi di custodia per attrezzi o materiali.

## Galvanized, wide mesh net.

Wider mesh, ideal for those looking to delimit storage areas for garden tools.

## Maille galvanisée large.

À Maille plus large, ce filet est parfait pour délimiter une aire de stockage pour les machines et les outils.

## Galvanizada con luz de malla grande.

Luz de malla más amplia, ideal para delimitar espacios donde guardar utensilios o maquinaria.

## Verzinkt mit großen Maschen.

Größere Masche, ideal für Lagerbereiche von Gartengeräten.

Cod.	m	-	EAN	N° x	x	x	€ m <sup>2</sup>	€ m	€	€
------	---	---	-----	------	---	---	------------------	-----	---	---

74040300	0.50x5	■	8002929039828	8	25	-	-	-	10,31	82,48
74040100	1.00x5	■	8002929033840	4	25	-	-	-	18,53	74,12

## EXAMET 10



14x14 mm – ø 0.7 mm

**Flessibile  
e multiuso.**

In filo di ferro zincato a triplice torsione, si presta a vari impieghi, quali lavori di bricolage, applicazioni agricole, gabbie per piccoli animali.

**Flexible  
and multi-purpose.**

A triple-twisted galvanized metal wire, suitable for many purposes such as DIY and agricultural use, i.e. cages for small animals.

**Flexible  
et multi-usages.**

Fil de fer galvanisé triple torsion, permet différentes utilisations: bricolage, agriculture, cages pour petits animaux.

**Flexible y multiuso.**

En alambre de hierro galvanizado de triple torsión, es perfecta para distintos usos como bricolaje, aplicaciones agrícolas y jaulas para pequeños animales.

**Flexibel  
und vielseitig.**

Ein dreifach verdrehter verzinkter Metalldraht, geeignet für viele Zwecke wie zum Beispiel für Heimwerker, in der Landwirtschaft oder für Kleintierkäfige.

Cod.	m	-	EAN	N° x	x	x	€ m <sup>2</sup>	€ m	€	€
74010500	0.50x10	■	8002929033796	8	25	-	-	-	13,90	111,20
74010600	1.00x10	■	8002929033802	4	25	-	-	-	25,49	101,96

## EXAMET 25



26x26 mm – ø 0.7 mm

**L'esagonale  
a maglia ampia.**

Nella maglia più ampia, si utilizza come delimitazione anche nell'allevamento di piccoli animali.

**Hexagonal,  
wide mesh net.**

With a larger mesh size. Suitable for use as fencing or cages for breeding small animals and poultry.

**L'hexagonal  
à maille large.**

À maille plus large, ce filet est également employé comme délimitation pour l'élevage de petits animaux.

**La hexagonal con  
luz de malla amplia.**

Con luz de malla más amplia, se utiliza para crear vallas de separación y recintos para la cría de pequeños animales.

**Sechseckig mit  
breiten Maschen.**

Mit einer größeren Masche. Geeignet für den Einsatz von Zäunen oder Käfigen für Kleintierzucht und Geflügel.

Cod.	m	-	EAN	N° x	x	x	€ m <sup>2</sup>	€ m	€	€
74020500	0.50x10	■	8002929033819	8	25	-	-	-	10,43	83,44
74020600	1.00x10	■	8002929033826	4	25	-	-	-	18,53	74,12

## QUADRAMET 10

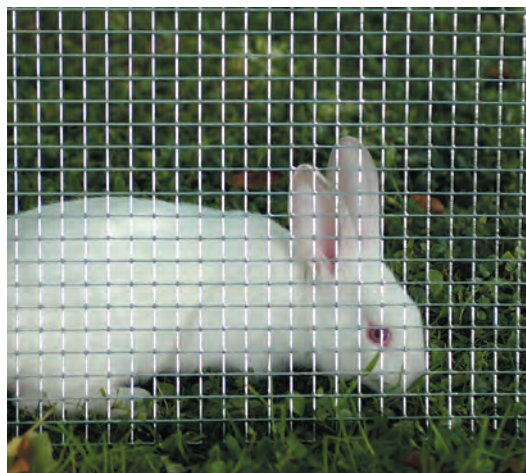

## EXAMET 10





## Bordure decorative

Le **bordure decorative** TENAX si utilizzano per delimitare, contenere e al tempo stesso abbellire prati ed aiuole. Proposte in materiali e forme diverse per assecondare gusti ed esigenze differenti, sono tutte molto semplici e veloci da porre in opera.

## Decorative lawn edging

TENAX lawn edgings are ideal for delimiting and decorating flower beds and lawns. They are available in a variety of materials and sizes to suit most uses and are quick and easy to install.

## Bordures décoratives

Barrières décoratives autour d'un parterre de fleurs ou d'une pelouse. Les bordures sont utilisées pour séparer et décorer en même temps. Elles sont disponibles dans des matériaux et des modèles différents très faciles et rapides à installer.

## Borduras decorativas

Las borduras TENAX se utilizan para cercar, proteger y al mismo tiempo decorar parterres y jardines. Los diferentes materiales y formatos satisfacen todos los gustos y exigencias y son muy fáciles y rápidos de instalar.

## Dekorative Rasenkanten

TENAX Rasenkanten sind ideal für Blumenbeete und Rasenbereiche, da sie diese sowohl abtrennen, als auch dekorieren. Sie sind in einer Vielzahl von Materialien und Größen verfügbar um sich an die meisten Anwendungen anzupassen und sind schnell zu installieren.

 **FLORET**

TOP QUALITY

UV TREATED

DURABILITY

REINFORCED

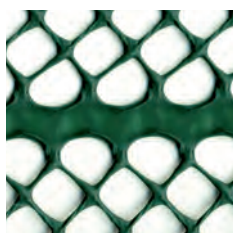

### Decorativa.

La rete Floret, dall'esclusivo disegno con banda centrale è ideale per delimitare con un tocco estetico aiuole e piante fiorite, è resistente e trattata contro i raggi UV.

### Decorative.

The Floret net, featuring an exclusively-designed central strip, is ideal for fencing off flowerbeds and flowering plants in a decorative way, is heavy-duty and UV treated.

### Décoratif.















Le filet Floret, au design exclusif avec sa bande centrale est idéal pour délimiter avec une touche esthétique, les parterres de fleurs et de plantes fleuries, il est résistant et est traité contre les rayons UV.

### Decorativa.

La malla Floret, de exclusivo diseño con banda central es ideal para delimitar con un toque estético parterres y plantas con flores, es resistente y está tratada contra los rayos UV.

### Dekorativ.

Das Gitter Floret, mit dem exklusiven Design mit dem Mittelstreifen, ist ideal um Beete und Blumen mit einem Touch Ästhetik abzugrenzen, es ist widerstandsfähig und gegen UV-Strahlen behandelt.

Cod.	m	-	EAN	N° x 	 x 	 x 	€ m <sup>2</sup>	€ m	€ 		
 1A120328	0.40x5		8002929104557	12	14	-	-	-	10,38	124,56	
 1A120329	0.60x5		8002929104564	12	7	-	-	-	15,01	180,12	
 	1A120330	0.40x25		8002929104571	-	-	40	3,59	1,44	-	35,90
	1A120331	0.60x25		8002929104588	-	-	30	3,52	2,11	-	52,80



# ONDADECÒ

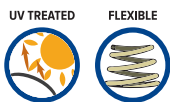

**Flessibile.**

In plastica ondulata, stabilizzata contro i raggi UV, è disponibile in diverse altezze. Conveniente e flessibile, è ideale per seguire i profili curvi di prati ed aiuole.

**Flexible lawn edging.**

Made of corrugated plastic and available in three sizes, this lawn edging is UV stabilized, cost effective and flexible. Ideally suited to curved borders, flowerbeds and lawns.

**Bordure flexible.**

En plastique ondulé, traité anti UV, elle est disponible en différentes hauteurs. Économique et flexible, elle s'adapte très facilement aux bordures incurvées des parterres de fleurs ou de la pelouse.

**Bordura flexible.**

De plástico ondulado, con tratamiento contra los rayos UV, está disponible en diferentes alturas. Gracias a su gran flexibilidad es ideal para bordear líneas curvas de jardines y parterres.

**Flexible Rasenkanten.**

Hergestellt aus gewellter Kunststoffolie und in drei Größen verfügbar ist diese Rasenkante UV-stabilisiert, kostengünstig und flexibel. Ideal für gebogene Abgrenzungen, Blumenbeete und Rasen.

Cod.	m	-	EAN	N° x	x	x	€ m <sup>2</sup>	€ m	€	€
72239837	0.09x10		5010453886002	12	25	-	-	-	7,65	91,80
72239838	0.17x10		5010453885005	6	25	-	-	-	13,56	81,36
3A074408	0.25x10		5010453337887	6	-	-	-	-	19,92	119,52

**ONDADECÒ**



**FLORET**

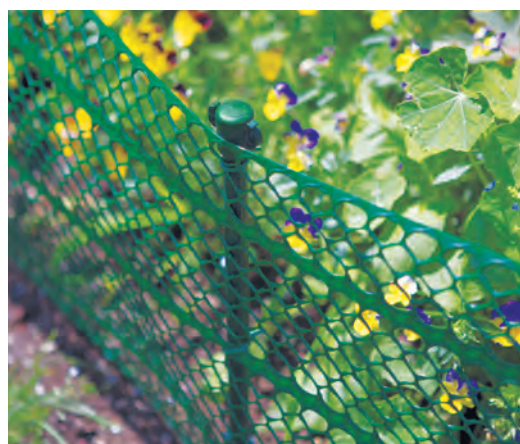

# GOTICDECÒ *Designed by Tenax*

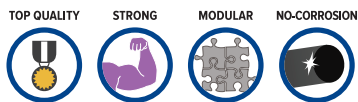

1



ø 5.8 mm

**Ad arco gotico.**  
Pannello in ferro trattato, robusto e resistente, rifinito con archi a sesto acuto. Per realizzare delimitazioni estese, i pannelli vanno accostati uno all'altro.

**Gothic arched edging.**  
Heavy-duty iron edging panel, finished with pointed arches. To create longer edging, the panels can simply be placed one next to the other.

**Bordure en forme d'arches gothiques.**  
Panneau en fer traité, solide et résistant, finition arches en ogive. Pour des bordures plus longues, les panneaux peuvent être facilement placés les uns à coté des autres.

**Bordura de arco gótico.**  
Panel de hierro tratado, robusto y resistente, acabado con arcos de punta. Para borduras más amplias será suficiente acoplar un panel con el otro.

**Gothische Bogenkanten.**  
Massive Eisenornamente mit Spitzbögen. Für längere Abgrenzungen können die Elemente einfach eine nach der anderen positioniert werden.

Cod.	m	-	EAN	N° x	x	x	€ m <sup>2</sup>	€ m	€	€
3A021128	0.38x0.6	■	5010453211286	6	-	-	-	-	6,85	41,10



## ONDAMET

PLASTIC COATED



ø 3 mm

**Delimitazione  
ad archi in ferro  
plastificato.**

In filo di ferro zincato, plastificato e ondulato. Resistente e flessibile, delimita graziosamente zone fiorite, aiuole e vialetti.

**Ornamental  
fence with arched  
finishing.**

Plastic-coated galvanized wire. Resistant and flexible, it attractively fences off flowerbeds and small paths.

**Clôture en forme  
d'arches.**

En fil de fer galvanisé, plastifié et ondulé. Résistante et flexible, elle clôture d'une manière décorative les parterres et les allées.

**Valla separadora  
con arcos.**

En alambre de hierro galvanizado, plastificado y ondulado. Resistente y flexible, delimita con estilo áreas ajardinadas, parterres y caminos.

**Dekorativer Zaun  
mit bogenförmiger  
Abschluss.**

Kunststoffbeschichteter verzinkter Draht. Beständig und flexibel, umzäunt er auf attraktive Weise Blumenbeete und kleine Wege.



Cod.	m	-	EAN	N° x	x	x	€ m <sup>2</sup>	€ m	€	€
74110200	0.40x10		5010453416001	-	-	46	-	-	-	23,36
74110100	0.65x10		5010453417008	-	-	23	-	-	-	32,64
3A021418	0.90x10		5010453418005	-	-	23	-	-	-	41,62



## ARCODECÒ

STRONG

MODULAR

PLASTIC COATED



0.42 x 0.46 m - n. 6 pcs

**Sei moduli  
ad arco tondo.**

In acciaio plastificato, è la più venduta. È composta da sei moduli di circa 42 cm agganciati e snodabili, utilizzabili anche nel caso di profili angolari di vialetti o di aiuole.

**Six round arched  
modules.**

Pre-linked and plastic-coated steel edging, Arcodecò is a best seller. It is made up of six interlocked modules of about 42 cm that can be adapted to angled paths or flowerbeds.

**Six modules en  
forme d'arches  
rondes.**

En acier plastifié, c'est la plus vendue: elle est composée de six modules d'environ 42 cm enclenchés et peut facilement s'adapter aux angles des allées et aux parterres de fleurs.

**Seis módulos  
con arco redondo.**

De acero plastificado, es la más vendida. Compuesta de seis módulos de unos 42 cm enganchados, enganchados entre ellos para poder adaptarse a los perfiles angulosos de caminos y parterres.

**Sechs Module  
mit Rundbögen.**

Arcodecò ist der Bestseller aus kunststoffummantelten, miteinander verbundenen Randbögen. Sechs gekoppelte Module von ungefähr 42 cm von Wegen oder Beeten angepasst werden.

Cod.	m	-	EAN	N° x	x	x	€ m <sup>2</sup>	€ m	€	€
3A021139	0.46x2.5		5010453211392	6	48	-	-	-	9,80	58,80

# WPC Flower BED



1



**Bordura componibile in WPC.**

Composta da polipropilene e polvere di legni pregiati (es. Quercia). La finitura, molto decorativa e piacevole al tatto, la rende perfetta per creare graziosi angoli su terrazze e nei giardini.

- Non marcisce, non si scheggia, non ospita insetti;
- Modulare e componibile.

**Modular edging in WPC.**

Composed of polypropylene and precious wood flour (e.g. Oak). The highly decorative finish, which is pleasing to the touch, makes it perfect to create gracious corners on terraces and in gardens.

- It does not rot, does not chip and does not host insects;
- Modular and interlocking.

**Bordure complémentaire en composite bois-plastique.**

Composée de polypropylène et poudre de bois précieux (par ex. chêne). La finition très décorative et agréable au toucher la rend parfaite pour créer de gracieux espaces sur les terrasses et dans les jardins.

- Il ne pourrit pas, ne se fendille pas, n'héberge pas les insectes;
- Système modulaire.

**Bordura modular de WPC**

Compuesta por polipropileno y polvo de maderas finas (ej. Roble). El acabado, muy decorativo y agradable al tacto, es perfecto para crear bonitos rincones en terrazas y jardines.

- No se pudre, no se astilla, no alberga insectos;
- Modular y componible.

**Zusammensetzbare Umrandung aus WPC.**

Wood-Plastic-Composite ist eine Mischung aus 2/3 echten Holzbestandteilen (z.B. Eiche) und 1/3 recyceltem Kunststoff. Die sehr dekorative Verzierung fühlt sich gut an und ist perfekt für Beete auf Terrassen und in Gärten.

- Vermodert nicht, splittert nicht, beherbergt keine Insekten;
- Modular und zusammensetzbar.

	Cod.	m	-	EAN	N° x	x	x	€ m <sup>2</sup>	€ m	€	€
1 set of 4 pcs	1A160339	0.6x0.6		8002929121448	2	-	-	-	-	46,95	93,90
1 set of 4 pcs	1A160340	1x1		8002929121455	2	-	-	-	-	64,95	129,90



VIDEO TUTORIAL

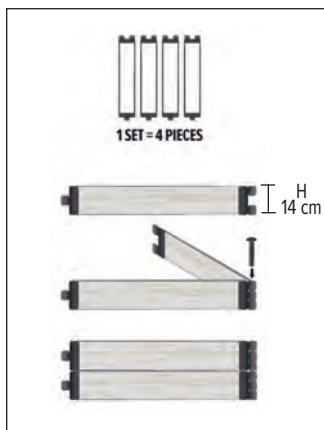

**SCHERMATURE  
DECORATIVE**

TexStyle  
schermatura di design  
Reti tessute  
Siepi sintetiche  
Cannicci sintetici

**DECORATIVE  
AND PRIVACY  
SCREENING**

TexStyle  
stylish screen  
Woven nets  
Synthetic hedges  
Synthetic reeds

**OCCULTATIONS  
DÉCORATIVES**

TexStyle  
occultation design  
Filets tissés  
Haies synthétiques  
Cannes synthétiques

**OCULTACIÓN  
DECORATIVA**

TexStyle  
ocultación de diseño  
Mallas tejidas  
Setos artificiales  
Cañizos artificiales

**DEKORATIVER  
SICHTSCHUTZ**

TexStyle  
Designabschirmung  
Sichtschutzgewebe  
Synthetische Hecken  
Synthetische Schilfe

36  
44  
56  
70

**TEXSTYLE**  
**Stile e design**  
**per il tuo**  
**dehors**

Una gamma innovativa di grande successo che ha introdotto la componente design per la schermatura da esterno. Realizzata con **disegni e nuances esclusive**, è **indemagliabile ed estremamente resistente** alle intemperie. Facile da tagliare a misura e rifinire, è **comodissima da installare** grazie ai suoi **occhielli** e all'apposito accessorio Tenax FISSARETE.

**Tante texture e tanti colori che si arricchiscono con i nuovi prodotti della collezione 2019.**

**TEXSTYLE**  
**Style and**  
**design**  
**for outdoor**

A successful and innovative range that has added a touch of style to outdoor screening meshes. Made with **exclusive patterns and shades**, it is **run-proof and extremely resistant** to weather elements. It is easy to cut to size and finish, as well as **easy to install** thanks to its **eyelets** and to the Tenax ELASTIC TIE accessory.

**A range of textures and colours that becomes wider with new products from the 2019 collection.**

**TEXSTYLE**  
**Style et design**  
**pour votre**  
**extérieur**

Une gamme innovante de grand succès qui a introduit le composant design pour les filets d'occultations externes. Réalisé avec des **dessins et des nuances exclusives**, il est **indémaillable et extrêmement résistant** aux intempéries. Facile à couper sur mesure et également de **simple** finition et **installation** grâce à ses **œillets** et à l'accessoire spécial Tenax CORDON ÉLASTIQUE.

**De nombreuses textures et de nombreuses couleurs s'enrichissent avec les nouveaux produits de la collection 2019.**

**TEXSTYLE**  
**Estilo y diseño**  
**para tu dehors**

Una gama innovadora de gran éxito que ha introducido el componente diseño para la ocultación de uso exterior. Realizada con **tramas y tonos exclusivos**, es **indesmallable y extremadamente resistente** a la intemperie. Fácil de cortar a medida y de rematar, es muy **sencilla de instalar** gracias a los **ojales** el especial accesorio Tenax FIJADOR.

**Muchas texturas y colores enriquecidos con los nuevos productos de la colección 2019.**

**TEXSTYLE**  
**Stil und Design**  
**für ihren**  
**Außenbereich**

Eine sehr erfolgreiche, innovative Palette, die das Element Design bei Außenabschirmungen eingeführt hat. Hergestellt mit **exklusiven Zeichnungen und Nuancen**, trennt nicht auf und ist **äußerst wetterbeständig. Einfach zuzuschneiden und zuzurichten**, dank der **Ösen** und des geeigneten Tenax Zubehörs bequem aufzubauen.

**Viele Texturen und viele Farben die sich mit den neuen Produkten der Kollektion 2019 bereichern.**

*Trendy & Fashion*

**APPLICAZIONI**

- Ideale per dare un tocco di stile a giardini, recinzioni, terrazze o balconi.
- Perfetta per proteggere e decorare anche le costruzioni più moderne.

**CARATTERISTICHE**

- In Textilene, composta da 70% PVC e 30% PET.
- Con occhielli antiruggine disposti ogni 30 cm circa lungo i bordi.
- Stabilizzata ai raggi UV.

**VANTAGGI**

- Novità ad altissimo impatto estetico.
- Facile da installare grazie agli occhielli.
- Semplice da tagliare a misura, non si sfilaccia.
- Indemagliabile.
- Super resistente a strappi, vento e sole.
- Diversi gradi di schermatura.
- Esclusiva Tenax.

**APPLICATIONS**

- Ideal for giving gardens, fences, terraces or balconies a touch of style.
- Perfect for protecting and decorating most modern buildings too.

**FEATURES**

- Produced from Textilene, 70% PVC and 30% PET.
- With rustproof eyelets placed approximately every 30 cm along the edges.
- UV treated.

**ADVANTAGES**

- New, with a huge aesthetic impact.
- Easy to install thanks to its eyelets.
- Easy to cut to size, it does not unravel.
- Run-proof.
- Extremely tear-resistant, as well as resistant to wind and sunlight.
- Different screening levels.
- Tenax exclusive.

**APPLICATIONS**

- Idéal pour ajouter une touche de style aux jardins, clôtures, terrasses ou balcon.
- Parfait pour protéger et même décorer les bâtiments les plus modernes.

**CARACTÉRISTIQUES**

- Textilene, composé de 70% PVC et 30% PET.
- Avec oeilletons anti-rouille disposés tous les 30 cm environ le long des bords.
- Stabilisé aux rayons UV.

**AVANTAGES**

- Nouveauté à impact esthétique très élevé.
- Facile à installer grâce aux oeilletons.
- Simple à couper sur mesure, ne s'effiloche pas.
- Indémaillable.
- Super résistant aux déchirures, vent et soleil.
- Différents degrés de protection.
- Exclusivité Tenax.

**APLICACIONES**

- Ideal para dar un toque de estilo a jardines, cercados, terrazas o balcones.
- Perfecta incluso para proteger y decorar las construcciones más modernas.

**CARACTERÍSTICAS**

- De Textilene, compuesta por 70% PVC y 30% PET.
- Con oiales anticorrosivos colocados cada 30 cm aproximadamente a lo largo de los bordes.
- Estabilizada a los rayos UV.

**VENTAJAS**

- Novedad de altísimo impacto estético.
- Sencilla de instalar gracias a los oiales.
- Fácil de cortar a medida, no se deshilacha.
- Indesmallable.
- Superresistente a la rotura, al viento y al sol.
- Diferentes porcentajes de ocultación.
- Exclusiva Tenax.

**ANWENDUNGEN**

- Ideal um Gärten, Umzäunungen, Terrassen oder Balkonen einen Touch Stil zu verleihen.
- Perfekt um auch die modernsten Konstruktionen zu schützen und zu dekorieren.

**EIGENSCHAFTEN**

- Aus Textilene, besteht aus 70% PVC und 30% PET.
- Mit rostfesten Ösen, die ungefähr alle 30 cm entlang der Ränder angebracht sind.
- Gegen UV-Strahlen stabilisiert.

**VORTEILE**

- Neuheit mit hoher ästhetischer Wirkung.
- Dank der Ösen einfach anzubringen.
- Leicht zuzuschneiden, zerfasert nicht.
- Maschenfest.
- Super reißfest, Wind- und Sonnenbeständig.
- Verschiedene Stufen der Abschirmung.
- Tenax Alleinverkaufsrecht.



**TEXSTYLE DOUBLE**

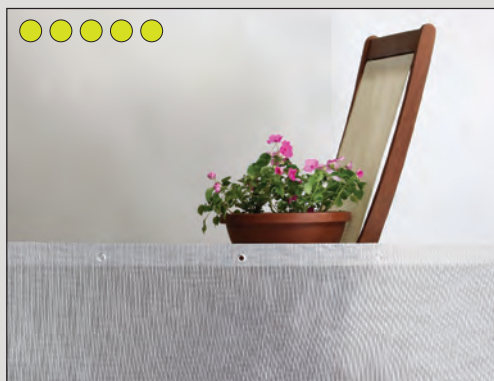

**TEXSTYLE ALL BLACK**

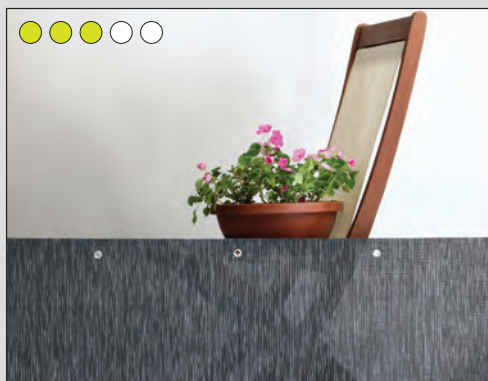

**Screening factor**

Grado stimato da prove di laboratorio realizzate internamente.

Level evaluated by laboratory testing performed internally.

Degré estimé sur tests de laboratoire effectués en interne.

**TEXSTYLE ALL GREEN**

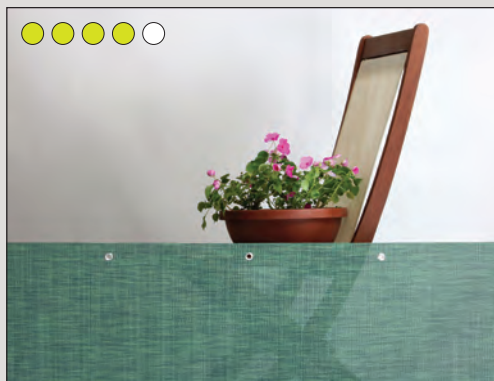

**TEXSTYLE PLUS**

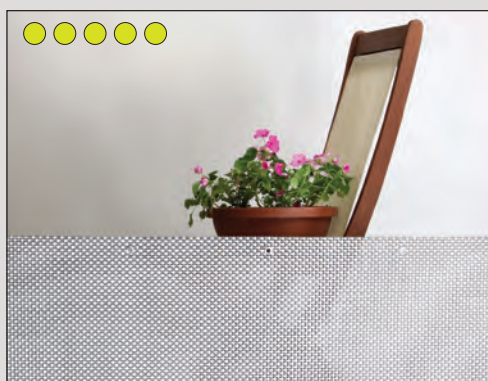

Porcentaje calculado según las pruebas de laboratorio realizadas internamente.

Grad durch innen durchgeführte Labortests.

**TEXSTYLE VIP**

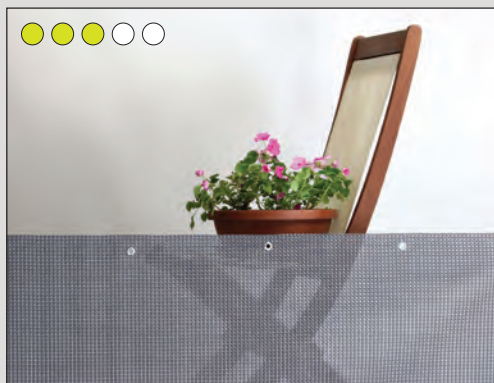

**TEXSTYLE PRIVÉ**

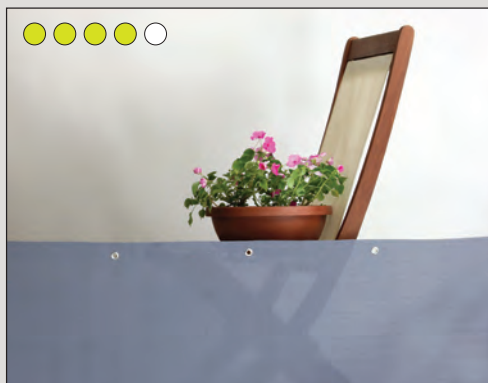

**TEXSTYLE PRIVÉ CHAMPAGNE**

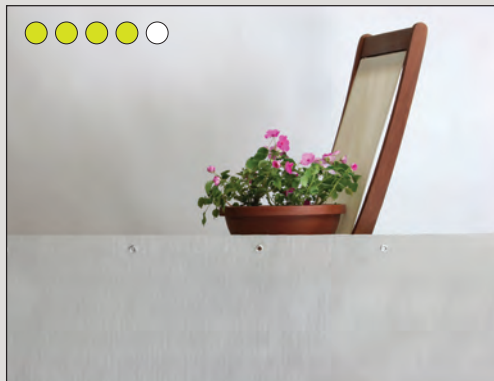

**TEXSTYLE PRIVÉ DARK**

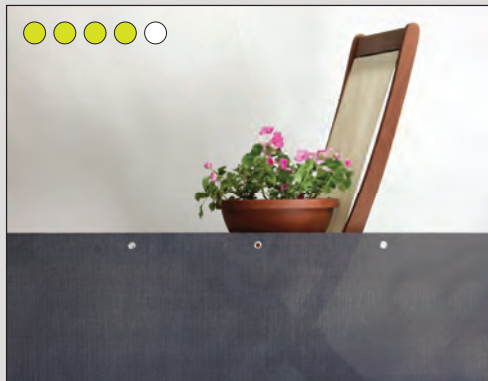





### TexStyle schermatura di design

Schermature in textilene particolarmente eleganti e raffinate, dall'alto contenuto di design, che proteggono la privacy e permettono di decorare con stile anche le costruzioni più moderne.

### TexStyle, stylish screen

Particularly elegant and refined **textilene** design **screens** which protect your privacy and are ideal for decorating also the most modern buildings in a stylish way.

### TexStyle, occultation design

**Occultations en textilene** particulièrement élégantes et raffinées à fort impact esthétique protégeant la vie privée et permettant de décorer avec style même les bâtiments les plus modernes.

### TexStyle ocultación de diseño

Mallas de **ocultación de textilene** particolarmente elegantes y refinadas, con elevado contenido de diseño, que protegen la intimidad y permiten decorar con estilo incluso las construcciones más modernas.

### TexStyle Design-abschirmung

Besonders elegante und raffinierte **Abschirmungen aus Textilien**, mit hohem Designanteil, die Privatsphäre schützen und erlauben auch moderne Konstruktionen mit Stil zu dekorieren.

## TEX Style DOUBLE *Designed by Tenax*

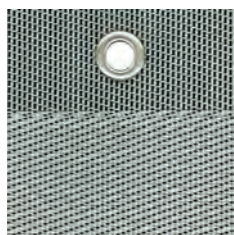

580 g/m<sup>2</sup>



#### Schermante e double-face.

Texture in colore argento con un effetto double face fine e d'impatto, ad alta schermatura. Il bordo in tessitura inversa crea un effetto cimosa che rifinisce il prodotto.

#### Double-faced and screening.

Highly screening silver weave with a refined and beautiful double-faced effect. The edge with reverse weave creates a selvedge effect that finishes the product.

#### Occultante et double-face.

Texture de couleur argent avec un effet double face raffiné et d'impact, à occultation élevée. Le bord au tissage inversé crée un effet de lisière qui termine le produit.

#### Ocultación de doble cara.

Textura de color plata con un efecto de dos caras fina y de impacto con alto grado de ocultación. El borde con tejido inverso crea el efecto de un borde reforzado como acabado del producto.

#### Doppelseitige Abschirmung.

Texture in der Farbe Silber mit elegantem doppelseitigem Effekt und hochgradig abschirmend. Der umgekehrt gewebte Rand bildet eine Webkante, die das Produkt vollendet.

Cod.	m	-	EAN	N° x	x	x	€ m <sup>2</sup>	€ m	€	€
1A170292	1.00x5	■	8002929123947	4	20	-	-	-	47,90	191,60

## TEX Style ALL BLACK *Designed by Tenax*

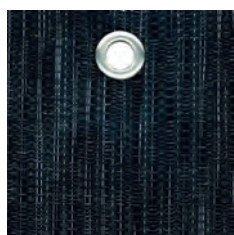
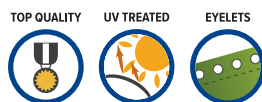

650 g/m<sup>2</sup>



**L'eleganza del nero.** Tessitura in colore nero ravvivata da fili metallizzati per un effetto moderno dalla media schermatura.

#### The elegance of black.

Black weave brightened by metallic threads for a modern effect and a medium screening.

#### L'élégance du noir.

Tissage à occultation moyenne de couleur noire, animé avec des fils métalliques pour un effet moderne.

#### La elegancia del negro.

Tejido de color negro con hilos metalizados para un efecto moderno de ocultación media.

#### Schwarze Eleganz.

Schwarzes Gewebe, mit metallisierten Fäden für einen modernen Effekt der mittleren Abschirmung.

Cod.	m	-	EAN	N° x	x	x	€ m <sup>2</sup>	€ m	€	€
1A170291	1.00x5	■	8002929123930	4	20	-	-	-	51,90	207,60

**TexStyle**  
schermatura  
di design

**TexStyle,**  
stylish  
screen

**TexStyle,**  
occultation  
design

**TexStyle**  
ocultación  
de diseño

**TexStyle**  
Design-  
abschirmung

**TEX**Style ALL GREEN *Designed by Tenax*

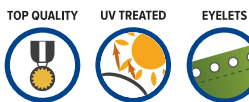

650 g/m<sup>2</sup>



**TexStyle in green.**  
Schermatura medio/  
alta dalla trama fitta  
di un verde intenso  
screziato da un verde  
più vivace per un  
effetto fresco  
ed elegante.

**TexStyle in green.**  
Medium/high  
screening with a thick  
weave of an intense  
green colour mottled  
by a more vivid  
green for a fresh and  
refined effect.

**TexStyle en vert**  
Occultation  
moyenne/haute  
à texture épaisse  
d'un vert intense,  
strié pour un effet  
frais et élégant.

**TexStyle en verde.**  
Ocultación media/alta  
con trama tupida  
de color verde  
intenso jaspeado  
con un verde más  
vivo para un efecto  
fresco y elegante.

**TexStyle in grün.**  
Mittlere/hohe  
Abschirmung  
mit dichtem Gewebe  
in einem intensiven  
Grün meliert mit  
einem lebendigeren  
Grün, für eine  
frische und elegante  
Wirkung.

Cod.	m	-	EAN	N° x	x	x	€ m <sup>2</sup>	€ m	€	€
1A170297	1.00x5		8002929123985	4	20	-	-	-	51,90	207,60

**TEX**Style PLUS *Designed by Tenax*

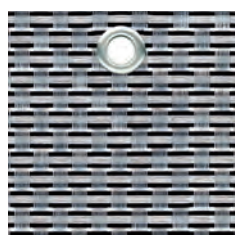

850 g/m<sup>2</sup>



**Il top di gamma.**  
Fili ampi di colore  
argento intrecciati  
a fili più sottili  
in nero per una  
tessitura altamente  
schermante,  
particolare e trendy.

**The top of the line.**  
Large silver threads  
woven with thinner  
black threads  
for a particular,  
trendy and highly  
screening mesh.

**Le top de la gamme.**  
Larges fils de couleur  
argent entrelacés  
avec des fils plus fins  
de couleur noire pour  
un tissage hautement  
protecteur  
et particulièrement  
tendance.

**Lo mejor de lo mejor.**  
Hilos amplios  
de color plata  
entrelazados  
con hilos más finos  
de color negro  
para un tejido de alta  
ocultación especial  
y trendy.

**Der Spitzenreiter der Serie.**  
Breite Fäden  
in der Farbe Silber,  
verwoben mit  
dünneren schwarzen  
Fäden bilden ein  
hoch abschirmendes,  
besonderes und  
modisches Gewebe.

Cod.	m	-	EAN	N° x	x	x	€ m <sup>2</sup>	€ m	€	€
1A140302	1.00x5		8002929113559	4	20	-	-	-	62,48	249,92

TEXTSTYLE ALL GREEN



**TexStyle  
schermatura  
di design**

**TexStyle,  
stylish  
screen**

**TexStyle,  
occultation  
design**

**TexStyle  
ocultación  
de diseño**

**TexStyle  
Design-  
abschirmung**

**TEX**Style VIP *Designed by Tenax*



700 g/m<sup>2</sup>



**Bassa schermatura,  
grande effetto.**

Schermatura bassa ottenuta dall'intreccio di fili sottili nei colori nero, argento e grigio per un effetto più decorativo e dall'alto contenuto di design.

**Low screening,  
great effect.**

Low screening obtained by weaving thin black, silver and grey threads for a more decorative and highly stylish effect.

**Occultation basse  
à grand effet.**

Brise-vue à occultation basse obtenu par le biais d'un entrelacement de fils fins aux couleurs noir, argent et gris pour un effet plus décoratif et à fort impact esthétique.

**Baja ocultación,  
gran efecto.**

Ocultación baja, obtenida con una trama de hilos finos de color negro, plata y gris, para un efecto más decorativo pero con un alto contenido de diseño.

**Geringe  
Abschirmung,  
große Wirkung.**

Geringe Abschirmung, bestehend aus dem Geflecht von dünnen schwarzen, silbernen und grauen Fäden, für eine dekorativere und designlastige Wirkung.

Cod.	m	-	EAN	N° x	x	x	€ m <sup>2</sup>	€ m	€	€
1A160196	1.00x3		8002929120366	4	-	-	-	-	35,98	143,92
1A140305	1.00x5		8002929113580	4	20	-	-	-	51,23	204,92
1A160197	1.50x5		8002929120373	4	-	-	-	-	76,18	304,72
1A160198	1.00x25		8002929120380	-	-	-	8,36	8,36	-	209,00



**TexStyle**  
schermatura  
di design

**TexStyle,**  
stylish  
screen

**TexStyle,**  
occultation  
design

**TexStyle**  
ocultación  
de diseño

**TexStyle**  
Design-  
abschirmung

**TEX** Style PRIVÉ *Designed by Tenax*

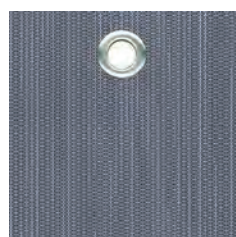

580 g/m<sup>2</sup>



**Semplice e moderna.**

Alta schermatura data dalla tessitura di fili sottili ed uniformi di colore grigio acciaio. Una texture più semplice ma dalla visual moderna.

**Simple and modern.**

High screening obtained by weaving thin, uniform, steel grey threads. A simpler texture with a modern visual impact.

**Simple et moderne.**

Haute occultation obtenue grâce au tissage de fils fins et uniformes de couleur gris acier. Une texture plus simple mais de style moderne.

**Sencilla y moderna.**

Alta ocultación obtenida por el tejido de hilos finos y uniformes de color gris acero. Una textura más sencilla pero con una visual moderna.

**Einfach und modern.**

Hohe Abschirmung, durch das Gewebe von dünnen und uniformen Fäden in der Farbe Stahlgrau. Eine einfachere Textur aber mit moderner Optik.

Cod.	m	-	EAN	N° x	x	x	€ m <sup>2</sup>	€ m	€	€
1A140303	1.00x5	■	8002929113566	4	20	-	-	-	41,20	164,80
1A140304	1.50x5	■	8002929113573	4	20	-	-	-	61,90	247,60
1A160199	1.00x25	■	8002929120397	-	-	-	6,26	6,26	-	156,50

**TEX** Style PRIVÉ CHAMPAGNE *Designed by Tenax*

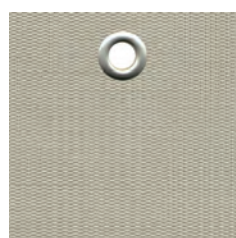
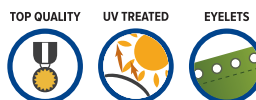

580 g/m<sup>2</sup>



**Ricercata e trendy.**

L'innovativa nuance champagne di questa texture la rende raffinata ed elegante. I fili sottili della tessitura la rendono compatta ed altamente schermante.

**Refined and trendy.**

The innovative champagne shade of this texture makes it refined and elegant. The thin threads of the weave make it compact and highly screening.

**Recherchée et branchée.**

La nouvelle nuance champagne de cette texture donne à la clôture un aspect raffinée et élégant. Les fils fins du tissage le rendent compact et fortement occultant.

**Sofisticada y trendy.**

La innovadora tonalidad champagne de esta textura la hace sofisticada y elegante. Los hilos finos del tejido la hacen compacta y muy tupida.

**Begeht und trendy.**

Die innovative Farbnuance Champagner dieser Textur macht es raffiniert und elegant. Die dünnen Fäden machen sie kompakt und hoch abschirmend.

Cod.	m	-	EAN	N° x	x	x	€ m <sup>2</sup>	€ m	€	€
1A160195	1.00x3	■	8002929120359	4	-	-	-	-	32,06	128,24

**TEXTSTYLE PRIVÉ**



**TexStyle**  
schermatura  
di design

**TexStyle,**  
stylish  
screen

**TexStyle,**  
occultation  
design

**TexStyle**  
ocultación  
de diseño

**TexStyle**  
Design-  
abschirmung

**TEX** Style PRIVÉ Dark *Designed by Tenax*

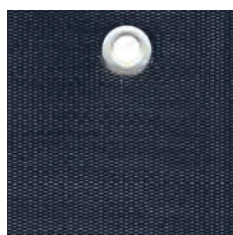
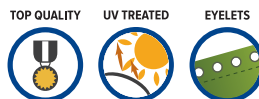

580 g/m<sup>2</sup>



**La nuova nuance.**  
Tessitura a fili fini  
e ravvicinati nel full  
color nero antracite,  
pieno ed uniforme  
per un alto grado  
di schermatura  
dal gusto ricercato.

**The new shade.**  
Weave with thin  
and close threads  
in charcoal black  
colour, full  
and uniform for  
a high screening level  
and a refined touch.

**La nouvelle nuance.**  
Filet tissé avec des  
fils fins et serrés  
de couleur noire  
anthracite, dense  
et uniforme pour  
un degré élevé  
d'occultation  
au goût raffiné.

**La nueva tonalidad.**  
Tejida con hilos  
finos y unidos  
de color negro  
antracita, intenso  
y uniforme con un  
alto porcentaje  
de ocultación  
y gusto sofisticado.

**Die neue Nuance.**  
Textur mit dünnen  
und engen Fäden  
in der Farbe schwarz  
anthrazit, voll  
und gleichmäßig  
für eine hochgradige  
Abschirmung  
mit raffiniertem  
Geschmack.

Cod.	m	-	EAN	N° x	x	x	€ m <sup>2</sup>	€ m	€	€
------	---	---	-----	------	---	---	------------------	-----	---	---

<b>NEW</b>	1A180265	1.00x5	■	8002929126436	4	-	-	-	-	41,20	164,80
<b>NEW</b>	1A180266	1.50x5	■	8002929125873	4	-	-	-	-	61,90	247,60

**Accessori**

**Accessories**

**Accessoires**

**Accesorios**

**Zubehör**

Cod.	m	-	EAN	N° x	x	x	€ m <sup>2</sup>	€ m	€	€
------	---	---	-----	------	---	---	------------------	-----	---	---

## FISSARETE per TexStyle – ELASTIC TIE for TexStyle – CORDON ÉLASTIQUE pour TexStyle – FIJADORA para TexStyle – ZAUNBEFESTIGUNG für TexStyle

Per schermature con occhielli – Ideal for screening nets with eyelets – Idéal pour filets avec oeilletons – Ideal para mallas de ocultación con ojales – Ideal für Sichtschutznetze mit Ösen  
Confezione da 10 pezzi – Pack of 10 pieces – Sachet de 10 pièces – Envasado en bolsas de 10 unidades – Packung mit 10 Stk.



1A140306	15 cm	■	8002929113597	20	-	-	-	-	2,50	50,00
----------	-------	---	---------------	----	---	---	---	---	------	-------





## Reti tessute

In polietilene, sono ideali in giardini o terrazzi installate in verticale per **riparare dalla vista o dal vento**, oppure tese orizzontalmente per **proteggere dai raggi solari spazi esterni** e dehors. Permettono di decorare con stile anche le costruzioni più moderne.



VIDEO TUTORIAL

## Woven nets

The polyethylene mesh is used in gardens or terraces installed vertically as **screening or shielding against wind**, or hung horizontally to **protect outdoor areas and vehicles against sunlight**. They provide stylish decoration even in the most modern buildings.

## Filets tissés

En polyéthylène trouvent emploi dans les jardins ou les terrasses. Installés à la verticale comme **brise-vent ou brise-vent**; ils se posent horizontalement pour **protéger les espaces externes des rayons solaires**. Permettent de décorer avec style les bâtiments les plus modernes.

## Mallas tejidas

Son de gran utilidad para jardines o terrazas. Pueden instalarse verticalmente para **ocultar y resguardar del viento** o bien pueden aplicarse horizontalmente para **proteger de los rayos solares tanto patios, terrazas, balcones**. Ofrecen decoración con estilo para las construcciones más modernas.

## Sichtschutzgewebe

Das Polyethylen Gewebe wird in Gärten oder auf Terrassen verwendet. Vertikal wird es als Sicht- oder Windschutz und horizontal als Sonnenschutz von Außenanlagen eingesetzt. Die neuen modernen Farben sind selbst in modernen Gebäuden sehr dekorativ.

**BERMUDA**

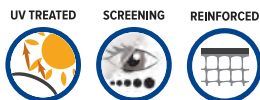

720 g/m<sup>2</sup>



### Due prodotti in uno.

Schermatura totale, ottenuta accoppiando una rete plastica rigida con un tessuto-non-tessuto molto coprente. Garantisce un'elevata resistenza allo strappo. Trattata per resistere ai raggi UV e mantenere il colore nel tempo. Il tessuto non tessuto deve essere posto a contatto con la recinzione esistente.

### Two products in one.

Total screening is provided by bonding a rigid supporting mesh and a nonwoven fabric which provides plenty of cover. It is UV treated and keeps its colour over time. Decorative and efficient, it should be used on supporting structures, by fixing to them the nonwoven fabric.

### Deux produits en un.

Occultation totale obtenue avec une maille plastique rigide et portante et un tissu non tissé très opaque. Très résistant à la déchirure. Traité ANTI UV pour conserver sa couleur. Le tissu non tissé doit être appliqué directement sur la clôture existante.

### Dos productos en uno.

Occultación total obtenida por la combinación de una malla rígida y un tejido-no-tejido. Garantiza una ocultación total y una elevada resistencia a la rotura. Tratada para resistir los rayos UV y para mantener el color con el paso del tiempo. Decorativa y de gran utilidad, se aplica sobre cercados ya instalados colocando la cara del tejido en contacto con la valla.

### Zwei Produkte in einem.

Zaun plus Abschirmung in nur einem Artikel, dank der Verbindung eines Gitters aus extrudiertem Polyethylen mit hoher Dichte und einem Vliesstoff mit 100% Abschirmung für ein maximales Ergebnis. Behandelt um gegen UV-Strahlen beständig und farbecht zu sein. Dekorativ und funktionstüchtig, es sollte mit der Stützkonstruktion befestigt werden.

Cod.	m	-	EAN	N° x	x	x	€ m <sup>2</sup>	€ m	€	€
1A040342	1.00x3		8002929068866	6	14	-	-	-	24,11	144,66
1A050290	1.50x5		8002929072931	2	12	-	-	-	60,29	120,58
1A040340	1.00x25		8002929068842	-	-	9	6,93	6,93	-	173,25
1A040341	1.50x25		8002929068859	-	-	9	6,93	10,40	-	259,88

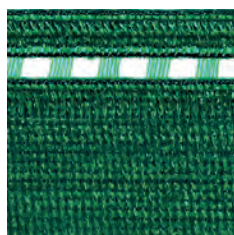
**COIMBRA**
230 g/m<sup>2</sup>**Coprente ed elegante.**

Rete tessuta in HDPE, di esclusiva lavorazione. Garantisce una schermatura totale, un'elevata resistenza allo strappo e una lunga durata del colore.

**The elegant fabric net.**

A woven mesh in HDPE using our exclusive manufacturing process. It guarantees total privacy and offers high strength; it is tear resistant and UV stabilized.

**Le filet tissé très élégant.**

















Filet tissé en HDPE de fabrication exclusive. Il garantit une protection totale, une grande résistance à la déchirure et un maintien de la couleur.

**Elegante de ocultación total.**

Malla tejida de HDPE con exclusiva elaboración. Garantiza una ocultación total, una elevada resistencia a la rotura y una larga durabilidad del color.

**Das elegante Sichtschutzgewebe.**

Gewebtes Netz aus HDPE in exklusiver Verarbeitung. Es garantiert absolute Privatsphäre und bietet hohe Festigkeiten; ist weiterreißfest und UV-stabilisiert.

Cod.	m	-	EAN	N° x 	 x 	 x 	€ m <sup>2</sup>	€ m	€ 	€ 
73312016	1.00x5		8002929059598	6	24	-	-	-	17,95	107,70
73312026	1.50x5		8002929059604	6	12	-	-	-	26,04	156,24
1A150239	2.00x5*		8002929116635	6	14	-	-	-	33,75	202,50
										
1A150190	1.00x50		8002929116307	-	-	28	2,88	2,88	-	143,82
1A160361	1.20x50		8002929121615	-	-	28	2,88	3,45	-	172,58
1A150191	1.50x50		8002929116314	-	-	28	2,88	4,31	-	215,73
1A160362	1.80x50		8002929121622	-	-	28	2,88	5,18	-	258,88
1A150192	2.00x50		8002929116321	-	-	28	2,88	5,75	-	287,64

**COIMBRA Dark**
230 g/m<sup>2</sup>**Schermatura totale.**

La versione trendy di Coimbra nel caratteristico colore antracite.

**Total screening.**

The trendy version of Coimbra in the typical charcoal colour.

**Ocultation totale.**















La version branchée de Coimbra dans la couleur distinctive anthracite.

**Ocultación total.**

La versión trendy de Coimbra en el característico color antracita.

**Totale Abschirmung.**

Die modische Version von Coimbra in der charakteristischen Farbe anthrazit.

Cod.	m	-	EAN	N° x 	 x 	 x 	€ m <sup>2</sup>	€ m	€ 	€ 
1A130262	1.00x5		8002929109446	6	24	-	-	-	17,95	107,70
1A130264	1.50x5		8002929109453	6	12	-	-	-	26,04	156,24
1A150237	2.00x5*		8002929116628	6	14	-	-	-	33,75	202,50
										
1A150193	1.00x50		8002929116338	-	-	28	2,88	2,88	-	143,82
1A150194	1.50x50		8002929116345	-	-	28	2,88	4,31	-	215,73
1A150195	2.00x50		8002929116352	-	-	28	2,88	5,75	-	287,64

\* Piegiate in rotoli da 1 m – Folded in 1 m rolls – Pliéés en rouleaux de 1 m – Dobladas en rollos de 1 m – Auf 1 m Breite gefaltet

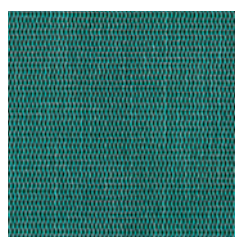
180 g/m<sup>2</sup>

**Lucida e brillante.**  
Rete a tessitura piana molto simile ad un tessuto. La maglia fitta e molto resistente garantisce un buon potere schermante. Nel colore verde brillante viene utilizzata come frangivista in giardini o attorno alle piscine per preservarne la privacy.

**Shiny and bright.**  
Flat weave mesh which is very similar to fabric. The tight and durable weave ensures good screening performance. The brilliant green is used as a privacy screen in the garden or around the swimming pool.

**Brillant et lumineux.**  
Filet au tissage plat qui est similaire à un tissu. La maille serrée et résistante garantit un bon pouvoir occultant. Le vert lumineux est utilisé comme brise vue dans les jardins ou autour des piscines pour préserver la vie privée.

**Brillante y luminosa.**  
Malla de tejido plano que resulta muy parecida a un tejido. Material muy compacto y resistente. El color verde brillante se utiliza como ocultación en jardines o alrededores de piscinas para preservar la intimidad.

**Glänzend und hell.**  
Das Sichtschutzwewebe garantiert durch seine enge und feste Webtechnik für einen besonders guten Sichtschutz. Das brillante Grün wird als Sichtschutz im Garten oder um das Schwimmbaden eingesetzt.

Cod.	m	-	EAN	N° x	x	x	€ m <sup>2</sup>	€ m	€	€
73335106	1.00x5	■	8002929000668	6	40	-	-	-	15,19	91,14
73335116	1.50x10	■	8002929054715	6	12	-	-	-	39,24	235,44



● 73035506	1.00x100	■	8002929013286	-	-	16	2,10	2,10	-	210,00
● 1A040332	1.50x100	■	8002929068682	-	-	16	2,10	3,15	-	315,00
● 73035556	2.00x100	■	8002929028662	-	-	16	2,10	4,20	-	420,00

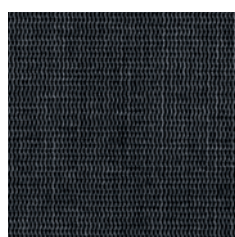

Con contametri  
With meter counter  
Avec compteurs métriques  
Con cinta métrica  
Mit Meterzähler

180 g/m<sup>2</sup>

**Nel nuovo colore grigio antracite.**  
Perfetta come schermatura e decorazione per ambienti raffinati e moderni.

**In the new charcoal grey colour.**  
Perfect as a screen or as decoration for refined and modern environments.

**Dans le nouveau gris anthracite.**  
Parfait comme occultation et décoration pour les environnements chics et modernes.

**En el nuevo color gris antracita.**  
Perfecta como ocultación y decoración para ambientes sofisticados y modernos.

**In der neuen Farbe anthrazitgrau.**  
Perfekt als Abschirmung und Dekoration für raffinierte und moderne Bereiche.

Cod.	m	-	EAN	N° x	x	x	€ m <sup>2</sup>	€ m	€	€
1A150221	1.00x5	■	8002929116512	6	40	-	-	-	15,19	91,14
1A150223	1.50x10	■	8002929116529	6	12	-	-	-	39,24	235,44



● 1A150226	1.00x100	■	8002929116543	-	-	16	2,10	2,10	-	210,00
● 1A150225	1.50x100	■	8002929116536	-	-	16	2,10	3,15	-	315,00
● 1A150227	2.00x100	■	8002929116550	-	-	16	2,10	4,20	-	420,00



Con contametri  
With meter counter  
Avec compteurs métriques  
Con cinta métrica  
Mit Meterzähler

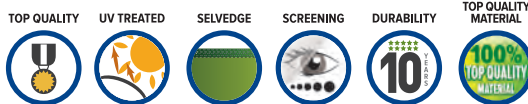

230 g/m<sup>2</sup>

### Schermatura e ombreggiamento double-face.

Schermatura di altissima qualità con piattina in HDPE 100% vergine: double-face, bianca da un lato e grigia dall'altro. La doppia tessitura le conferisce un elegante effetto mélange, un'elevata resistenza allo strappo e un maggiore potere schermante.

### Double-faced screening and shading mesh.

High-quality screen 100% virgin HDPE flat weave: double-faced, white on one side and grey on the other. The double weave results in an elegant mélange effect, high tear resistance and greater screening.

### Occultation et ombrage double face.

Occultation de haute qualité tissée avec une sangle en 100% HDPE vierge: double-face, blanc d'un côté et gris de l'autre. Le double tissage confère un élégant effet de mélange, une haute résistance à la déchirure ainsi qu'une capacité occultante majeure.

### Malla de ocultación de doble cara.

Malla de ocultación de altísima calidad tejida con rafia plana de HDPE 100% virgen: doble cara, blanca por un lado y gris por el otro. El doble tejido le proporciona un elegante efecto mezclilla, una elevada resistencia a la rotura y un mayor poder de ocultación.

### Doppelseitige Abschirmung.

Hochwertige Abschirmung, gewebt aus Flachdraht aus 100% HDPE: Doppelseitig, auf einer Seite weiß, auf der anderen grau. Die doppelte Webtechnik verleiht ihr einen eleganten Melange-Effekt, eine hohe Reißfestigkeit und eine größere Abschirmungsfähigkeit.

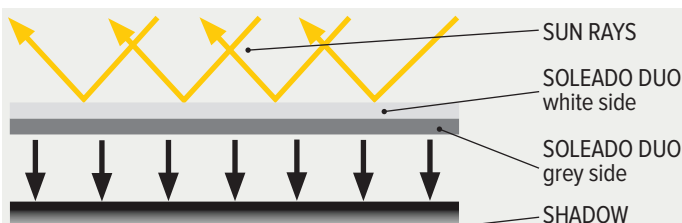

Il lato bianco riflette i raggi del sole e mantiene l'ambiente ombreggiato più fresco.

The white side reflects the sunlight and keeps the shaded environment cooler.

Le côté blanc réfléchit les rayons du soleil et maintient l'environnement ombragé plus frais.

La cara blanca refleja los rayos del sol y mantiene el ambiente sombreado más fresco.

Die weiße Seite reflektiert die Sonnenstrahlen und hält somit den Schattenbereich kühler.



Cod.	m	-	EAN	N° x	x	x	€ m <sup>2</sup>	€ m	€	€
1A170285	1.00x5		8002929123879	6	-	-	-	-	16,50	99,00
1A170286	1.50x5*		8002929123886	6	-	-	-	-	23,90	143,40
1A170287	2.00x5*		8002929123893	6	-	-	-	-	29,90	179,40
1A170299	4.00x3		8002929124005	6	-	-	-	-	34,90	209,40
										
1A170288	1.00x50		8002929123909	-	-	24	2,58	2,58	-	129,00
1A170300	1.50x50		8002929124012	-	-	18	2,58	3,87	-	193,50
1A170301	2.00x50*		8002929124029	-	-	12	2,58	5,16	-	258,00
1A170298	4.00x30**		8002929123992	-	-	12	2,58	10,32	-	309,60

\* Piegare in rotoli da 1 m – Folded in 1 m rolls – Pliées en rouleaux de 1 m – Dobladas en rollos de 1 m – Auf 1 m Breite gefaltet

\*\* Piegare in rotoli da 2 m – Folded in 2 m rolls – Pliées en rouleaux de 2 m – Dobladas en rollos de 2 m – Auf 2 m Breite gefaltet

95 g/m<sup>2</sup>**Bicolore per lo sport.**

Rete tessuta a strisce orizzontali di altezza 11 cm, in due colori alternati. Particolarmente vivace e visibile, è ideale nelle zone turistiche, attorno a piscine, nei campeggi o intorno ai campi sportivi.

**Holiday time & sports field.**

Woven net with two alternatively coloured horizontal stripes (11 cm), ideal for use in seaside areas as a shade net, or around swimming pools and on campsites.

**Un air de vacances et de sport.**

Filet tissé aux rayures horizontales de 11 cm de hauteur, en deux couleurs alternées, il est coloré et très visible. Utilisé dans les lieux touristiques, il est idéal au bord des piscines et dans les campings.

**Aire de vacances y de deporte.**

Malla tejida con bandas horizontales de 11 cm en dos colores alternativos. Especialmente llamativa y visible, es perfecta para instalaciones en zonas turísticas, alrededor de piscinas o campings.





**Freizeit & Sportplätze.**

Sichtschutzgewebe mit zwei verschieden farbigen horizontalen Streifen (11 cm). Ideal für den Einsatz in Küstenregionen als Schattennetz oder um Schwimmbecken und auf Campingplätzen.

Cod.	m	-	EAN	N° x 	 x 	 x 	€ m <sup>2</sup>	€ m	€ 	€ 
------	---	---	-----	--	---	---	------------------	-----	---	---

<b>NEW</b>	1A180273	1.00x5		8002929125934	6	24	-	-	11,36	68,16
	1A160323	1.00x5		8002929121325	6	24	-	-	11,36	68,16
	1A160325	1.00x5		8002929121332	6	24	-	-	11,36	68,16
	73330051	2.00x5*		8002929027696	6	24	-	-	15,50	93,00
	1A160342	2.00x5*		8002929121462	6	24	-	-	15,50	93,00
	1A160327	2.00x5*		8002929121349	6	24	-	-	15,50	93,00
	1A160329	2.00x5*		8002929121356	6	24	-	-	15,50	93,00



	1A160333	2.00x100*		8002929121387	-	-	18	0,92	1,84	-	184,00
	1A160334	2.00x100*		8002929121394	-	-	18	0,92	1,84	-	184,00
	1A160332	2.00x100*		8002929121370	-	-	18	0,92	1,84	-	184,00
	1A160331	2.00x100*		8002929121363	-	-	18	0,92	1,84	-	184,00

\* Piegare in rotoli da 1 m – Folded in 1 m rolls – Pliéés en rouleaux de 1 m – Dobladas en rollos de 1 m – Auf 1 m Breite gefaltet

**TENAX SOLEADO SPORT** è la soluzione innovativa per schermare i campi sportivi (calcio, rugby e altri sport) con i colori delle società sportive.

**TENAX SOLEADO SPORT** is the innovative solution to screen sport fields with teams colours (football, rugby and other sports).

**TENAX SOLEADO SPORT** est la solution innovante pour occulter les terrains de sport avec les couleurs des équipes sportives (football, rugby et autres sports).

**TENAX SOLEADO SPORT** es la solución innovadora para ocultar los campos deportivos (fútbol, rugby, y otros deportes) con los colores de las sociedades.

**TENAX SOLEADO SPORT** ist eine innovative Lösung, um die Sportplätze mit den Farben der Mannschaften (Fußball, Rugby und andere Sport) zu schützen.

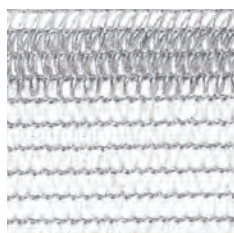
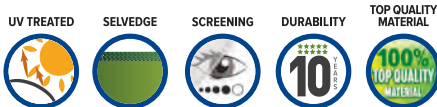

**SOLEADO** *in White*
95 g/m<sup>2</sup>**Luminosa ed elegante.**

Rete tessuta nel nuovo colore bianco, protegge la privacy rendendo gli ambienti particolarmente luminosi e freschi. Perfetta se accostata alle architetture dai colori chiari, in particolar modo nelle zone di villeggiatura e di mare.

**Light and elegant.**

The new brilliant white fabric mesh protects privacy and makes environments particularly bright and fresh. Perfect alongside light coloured buildings, such as holiday resorts.

**Lumineux et élégant.**









Filet tissé dans la nouvelle couleur blanche, protège la vie privée en rendant les espaces particulièrement lumineux et frais. Parfait s'il se marie aux architectures de couleurs claires, en particulier dans les zones de villégiature.

**El tejido luminoso y elegante.**

Malla tejida en el nuevo color blanco. Preserva la intimidad a la vez que otorga luminosidad y frescor al ambiente. Perfecta en diseños arquitectónicos en colores claros, especialmente en zonas turísticas.

**Leicht und elegant.**

Das neue strahlend weiße Sichtschutznetz schützt Ihre Privatsphäre und macht die Umgebung besonders hell und lebendig. Perfekt an hellen Gebäude wie Ferienanlagen.

Cod.	m	-	EAN	N° x 	 x 	 x 	€ m <sup>2</sup>	€ m	€ 	€ 
1A150231	1.00x5	<input type="checkbox"/>	8002929116598	6	30	-	-	-	11,36	68,16
1A150233	1.50x5*	<input type="checkbox"/>	8002929116604	6	24	-	-	-	14,88	89,28
1A150235	2.00x10*	<input type="checkbox"/>	8002929116611	6	14	-	-	-	31,58	189,48
										
1A150228	1.00x50	<input type="checkbox"/>	8002929116987	-	-	50	1,06	1,06	-	53,00
1A150229	1.50x50	<input type="checkbox"/>	8002929116574	-	-	50	1,06	1,59	-	79,50
1A150230	2.00x50*	<input type="checkbox"/>	8002929116581	-	-	32	1,06	2,12	-	106,00

\* Piegate in rotoli da 1 m – Folded in 1 m rolls – Pliées en rouleaux de 1 m – Dobladadas en rollos de 1 m – Auf 1 m Breite gefaltet



# SOLEADO CORTEN

95 g/m<sup>2</sup>

**Trendy ed esclusiva.**  
Rete tessuta nel caldo colore corten, oggetto di design e decorazione che dona un tocco di stile alle costruzioni moderne rendendole al tempo stesso raffinate ed accoglienti.

**Trendy and special.**  
Hot corten coloured fabric mesh, an object of design and decoration that gives modern buildings a touch of style, at the same time making them elegant and inviting.

**Trendy et spécial.**  
Filet tissé dans la chaude couleur corten, objet de conception et de décoration qui donne une touche de style aux constructions modernes en les rendant raffinées et élégantes.

**Ocultación a la moda.**  
Malla tejida de color marrón corten cálido que permite decorar espacios modernos aportando un estilo refinado y acogedor. Ideal para conseguir privacidad o para sombreo en terrazas y jardines.

**Trendig und speziell.**  
Rostfarbenes Sichtschutz-gewebe als Design- und Dekorationelement das modernen Gebäuden einen Hauch von Stil verleiht und sie gleichzeitig elegant und einladend erscheinen lässt.

Cod.	m	-	EAN	N° x	x	x	€ m <sup>2</sup>	€ m	€	€
1A150267	1.00x5	■	8002929116833	6	30	-	-	-	11,36	68,16
1A150269	1.50x5*	■	8002929116840	6	24	-	-	-	14,88	89,28
1A150271	2.00x10*	■	8002929116857	6	14	-	-	-	31,58	189,48
1A150273	1.00x50	■	8002929116864	-	-	50	1,06	1,06	-	53,00
1A150274	1.50x50	■	8002929116871	-	-	50	1,06	1,59	-	79,50
1A150275	2.00x50*	■	8002929116888	-	-	32	1,06	2,12	-	106,00

\* Piegare in rotoli da 1 m – Folded in 1 m rolls – Pliéés en rouleaux de 1 m – Dobladas en rollos de 1 m – Auf 1 m Breite gefaltet

# SOLEADO Glam

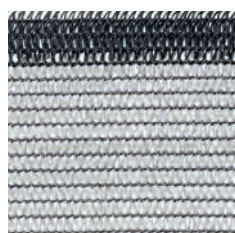
95 g/m<sup>2</sup>

**Accattivante ed innovativa.**  
La schermatura nel trendy e accattivante colore grigio chiaro. Molto robusta e coprente, è ideale per proteggere dalla vista e decorare al tempo stesso giardini e terrazzi.

**Attractive and innovative.**  
Very robust and providing excellent cover, with a modern and attractive colour, ideal for protecting the privacy of gardens and terraces, as well as decorating them.

**La vie privée est plus tendance.**  
Très robuste et opaque, disponible dans une couleur moderne et attractive, idéale pour, à la fois protéger de la vue, et décorer jardins et terrasses.

**La intimidad es trendy.**  
Es una malla tejida moderna y llamativa de color gris claro. Muy estable y tupida, es ideal para preservar la intimidad y decorar al mismo tiempo jardines y terrazas.

**Privatsphäre ist angesagt.**  
Sehr robust und für einen hervorragende Schutz. Mit einer modernen und attraktiven Farbe, ideal zum Schutz der Privatsphäre in Gärten und Terrassen, sowie für deren Dekoration.

Cod.	m	-	EAN	N° x	x	x	€ m <sup>2</sup>	€ m	€	€
1A130318	1.00x5	■	8002929110008	6	24	-	-	-	11,36	68,16
1A130319	1.50x5*	■	8002929110015	6	24	-	-	-	14,88	89,28
1A140068	2.00x10*	■	8002929111838	6	14	-	-	-	31,58	189,48
1A130320	1.00x50	■	8002929110022	-	-	50	1,06	1,06	-	53,00
1A130321	1.50x50	■	8002929110039	-	-	50	1,06	1,59	-	79,50
1A140067	2.00x50*	■	8002929111821	-	-	32	1,06	2,12	-	106,00

\* Piegare in rotoli da 1 m – Folded in 1 m rolls – Pliéés en rouleaux de 1 m – Dobladas en rollos de 1 m – Auf 1 m Breite gefaltet

**SOLEADO PRO**

TOP QUALITY

UV TREATED

SCREENING

SELVEDGE

DURABILITY

TOP QUALITY MATERIAL

100 g/m<sup>2</sup>**Il prodotto leader.**

Molto robusta e coprente, con bordi laterali rinforzati. Prodotta con piattina di prima scelta, uniforme, non ritorta e perfettamente planare, è trattata per resistere ai raggi UV e mantenere a lungo il colore nel tempo. Viene utilizzata prevalentemente come schermatura su recinzioni ma indicata anche per utilizzo in orizzontale come ombreggiante.

**The market leader.**

Very robust and highly screening woven net. Its selvedge allows to be fit onto fences, avoiding tearing. Produced with first quality polymer, with uniform and flat weave. It is treated to resist UV rays and keeps its colour over time. It is mainly used as a screen on fences but is also indicated for horizontal use for shading.

**La marque leader.**

Très solide et opaque aux bords renforcés. Fabriqué avec un polymère de haute qualité, uniforme et parfaitement plat, il est traité anti UV pour préserver sa couleur. Il est principalement employé comme brise-vue sur les clôtures mais est également indiqué pour être utilisé horizontalement comme ombrière.

**La más vendida.**

Malla muy robusta y tupida, con refuerzos en los bordes. Producida con materiales de primera calidad, está tratada para resistir los rayos UV y garantizar una larga durabilidad del color. Puede utilizarse en vertical para la ocultación de recintos o en horizontal como sombreadora.

**Der Bestseller.**

Sehr robust und hoch abschirmendes Gewebe. Sein Saum verhindert das Einreißen. Hergestellt aus erstklassigem Polymer mit gleichmäßiger und glatter Webtechnik. Es ist behandelt um der UV-Strahlung zu widerstehen und behält seine Farbe dauerhaft. Es wird vor allem als Sichtschutz an Zäunen, aber auch für den horizontalen Einsatz zum Schattenspenden verwendet.

Cod.	m	-	EAN	N° x 	 x 	 x 	€ m <sup>2</sup>	€ m	€  	€  
										
73031116	1.00x50		8002929037442	-	-	50	0,83	0,83	-	41,50
73030156	1.00x100		8002929013200	-	-	32	0,80	0,80	-	80,00
1A060341	1.20x100		8002929076380	-	-	32	0,80	0,96	-	96,00
73031216	1.50x50		8002929037459	-	-	36	0,83	1,25	-	62,25
73030126	1.50x100		8002929023698	-	-	32	0,80	1,20	-	120,00
1A090222	1.80x100		8002929088819	-	-	16	0,80	1,44	-	144,00
73031316	2.00x50		8002929037466	-	-	36	0,83	1,66	-	83,00
73030206	2.00x100		8002929013217	-	-	15	0,80	1,60	-	160,00
73030306	3.00x100		8002929013224	-	-	15	0,80	2,40	-	240,00
73031416	4.00x50		8002929037473	-	-	28	0,83	3,32	-	166,00
73030406	4.00x100		8002929013231	-	-	9	0,80	3,20	-	320,00
73030456	6.00x100		8002929013248	-	-	4	0,80	4,80	-	480,00
73030506	8.00x50		8002929013255	-	-	15	0,83	6,64	-	332,00

**SOLEADO CORTEN****SOLEADO PRO**

# SOLEADO - SOLEADO HG

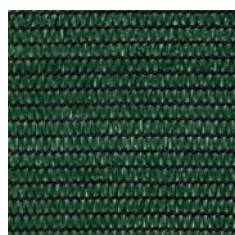
70 g/m<sup>2</sup>

## La schermatura tradizionale.

SOLEADO HG è la tradizionale rete tessuta Made in Italy ideale sia come schermatura se applicata in verticale che come ombreggiante in orizzontale. Prodotta con piattina di primissima qualità, ha schermatura media. Da quest'anno in vendita anche in comode buste inserite in promobox.

## The traditional screening.

SOLEADO HG is the traditional woven net Made in Italy, ideal both for screening, if installed vertically, and for shading, if installed horizontally. Made of high-quality flat threads; medium screening. From this year on, it is also sold in convenient bags inserted in promobox.

## L'occultation traditionnelle.

SOLEADO HG est le filet tissé traditionnel Made in Italy, idéal comme occultation appliquée en vertical ou en horizontal. Produit avec une sangle de qualité supérieure, occultation moyenne. À partir de cette année, en vente également sous forme de sachet pratique inséré en promobox.

## La ocultación tradicional.

SOLEADO HG es la tradicional malla tejida Made in Italy ideal tanto para ocultar si se coloca en vertical, como para sombrear en horizontal. Fabricada con rafia plana de altísima calidad, ocultación media. A partir de este año se vende también en cómodas bolsas en promobox.

## Die traditionelle Abschirmung.

SOLEADO HG ist das traditionelle Netz Made in Italy, ideal sowohl als vertikal angebrachte Abschirmung als auch als horizontaler Schattenspender. Hergestellt aus hochwertigem Flachdraht, mittlere Abschirmung. Seit diesem Jahr auch in praktischen Taschen erhältlich, die in die Promobox eingeordnet sind.

Cod.	m	-	EAN	N° x	x	x	€ m <sup>2</sup>	€ m	€	€	
73330036	1.00x5	■	8002929036117	6	24	-	-	-	7,79	46,74	
73331096	1.00x15	■	8002929036049	6	24	-	-	-	16,78	100,68	
73330046	1.50x5*	■	8002929036124	6	24	-	-	-	9,64	57,84	
73331146	1.50x15*	■	8002929036056	6	14	-	-	-	25,11	150,66	
73331056	2.00x5*	■	8002929059536	6	24	-	-	-	11,78	70,68	
1A030238	2.00x10*	■	8002929064257	6	24	-	-	-	20,15	120,90	
73331196	2.00x15*	■	8002929036063	6	14	-	-	-	31,99	191,94	
1A030239	4.00x3*	■	8002929064264	6	24	-	-	-	12,95	77,70	
<b>NEW</b>	1A180394	1.00x3	■	8002929126757	60 Promobox	-	-	-	4,56	273,60	
<b>NEW</b>	1A180395	2.00x5	■	8002929126771	20 Promobox	-	-	-	11,78	235,60	
<b>NEW</b>	1A180396	2.00x10	■	8002929126795	15 Promobox	-	-	-	20,15	302,25	
	1A130433	1.00x100	■	8002929110947	-	-	50	0,60	0,60	-	60,00
	1A130434	1.50x100	■	8002929110954	-	-	50	0,60	0,90	-	90,00
	1A130435	2.00x100	■	8002929110961	-	-	32	0,60	1,20	-	120,00
	1A130436	3.00x100	■	8002929110978	-	-	28	0,60	1,80	-	180,00
	1A130437	4.00x100	■	8002929110985	-	-	12	0,60	2,40	-	240,00
	1A130438	6.00x100	■	8002929110992	-	-	9	0,60	3,60	-	360,00

\* Piegare in rotoli da 1 m – Folded in 1 m rolls – Pliéés en rouleaux de 1 m – Dobladas en rollos de 1 m – Auf 1 m Breite gefaltet

I rotoli da h 4-6 m sono piegati in rotoli da 2 m; h 3 m piegati in rotoli da 1.5 m; h 2 m piegati in rotoli da 1 m.

4 m, 6 m high products are folded in 2 m rolls. 3 m high products are folded in 1.5 m rolls, 2 m high products are folded in 1 m rolls

Les hauteurs 4 m, 6 m sont pliées en rouleaux de 2 m. Les hauteurs 3 m sont pliées en rouleaux de 1.5 m. Les hauteurs 2 m sont pliées en rouleaux de 1 m.

Las alturas de 4 m, 6 m están dobladas en rollos de 2 m. Las alturas de 3 m están dobladas en rollos de 1.5 m.

Las alturas de 2 m están dobladas en rollos de 1 m

Die Abmessungen 4 m und 6 m sind auf 2 m Breite gefaltet. Die Abmessungen 3 m sind auf 1.5 m Breite gefaltet. Die Abmessungen 2 m sind auf 1 m Breite gefaltet.

## ALOHA

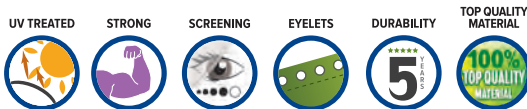

160 g/m<sup>2</sup>  
Screening 90%



### Rete frangivista ad alta schermatura con occhielli.

Rete tessuta con 5 anni di garanzia in HDPE 100% vergine. Aloha ha un alto grado di schermatura ed è totalmente indemagliabile e molto resistente a strappi ed intemperie. Di facilissima e veloce installazione grazie ai comodi occhielli in alluminio lungo i bordi. Resistente ai raggi UV, mantiene il colore inalterato e brillante nel tempo. Ideale per preservare la privacy e per schermare dal vento balconi, recinzioni o cancellate.

### Highly screening privacy screen with eyelets.

Woven net made of 100% virgin HDPE with a 5 year guarantee. Aloha offers high screening and is totally run-resist, it is very tear-resistant and weatherproof. Easy and quick to install thanks to the aluminium eyelets along its edges. UV treated, it maintains its bright colour over time. Ideal for protecting your privacy and for screening balconies, fences or gates from wind.

### Filet brise-vue à haute occultation avec oeillets.

Filet tissé en HDPE 100% vierge avec 5 ans de garantie. Le filet Aloha possède un degré élevé de protection. Il est totalement indémaillable et très résistant aux déchirures et aux intempéries. Facile et rapide à installer grâce à la présence d'oeillets pratiques sur toute la longueur des bords. Résistant aux rayons UV, la couleur demeure inaltérée et brillante au fil du temps. Idéal pour préserver l'intimité et protéger du vent les balcons, les clôtures ou les balustrades.

### Malla de protección visual con ojales de alta ocultación.

Malla tejida con 5 años de garantía en HDPE 100% virgen. Aloha posee un alto grado de ocultación y es completamente indemallable y muy resistente a las roturas y a la intemperie. Muy fácil y rápida de instalar gracias a los cómodos ojales de aluminio a lo largo de los bordes. Resistente a los rayos UV, mantiene el color inalterado y brillante durante largo tiempo. Ideal para preservar la intimidad y para proteger del viento balcones, cercados o vallas.

### Sichtschutznetz mit Ösen, hohe Abschirmung.

Gewebtes Netz mit 5 Jahren Garantie aus 100% reinem HDPE. Aloha schirmt sehr gut ab, ist völlig maschenfest und sehr reiß- und wetterfest. Dank der bequemen Ösen aus Aluminium entlang der Ränder ist es sehr einfach und schnell anzubringen. UV beständig, die Farbe bleibt mit der Zeit unverändert und leuchtend. Ideal um die Privatsphäre zu schützen und Balkone, Zäune oder Gitter vor Wind zu schützen.

	Cod.	m	-	EAN	N° x	x	x	€ m <sup>2</sup>	€ m	€	€
<b>NEW</b>	1A180310	1.00x5		8002929126238	6	-	-	-	-	14,01	84,06
<b>NEW</b>	1A180321	1.00x5		8002929126320	6	-	-	-	-	14,01	84,06
<b>NEW</b>	1A180311	1.50x5*		8002929126245	6	-	-	-	-	20,31	121,86
<b>NEW</b>	1A180322	1.50x5*		8002929126337	6	-	-	-	-	20,31	121,86
<b>NEW</b>	1A180312	2.00x5**		8002929126252	6	-	-	-	-	26,62	159,72

\* Piegare in rotoli da 0.75 m – Folded in 0.75 m rolls – Pliées en rouleaux de 0.75 m – Dobladas en rollos de 0.75 m – Auf 0.75 m Breite gefaltet

\*\* Piegare in rotoli da 1 m – Folded in 1 m rolls – Pliées en rouleaux de 1 m – Dobladas en rollos de 1 m – Auf 1 m Breite gefaltet



## JAMAICA

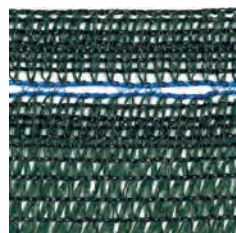

90 g/m<sup>2</sup>  
Screening 85%

**Schermante con asole.**

Rete tessuta con buona schermatura dotata di asole per una veloce installazione.

**Screening mesh with buttonholes.**

Woven net with a good screening level and convenient buttonholes for a quick installation.

**Occultation avec boutonnière.**

Filet tissé disposant d'une bonne occultation avec finition boutonnière, pratique pour une installation rapide.

**Malla de ocultación con ojales.**

Malla tejida con buena ocultación y cómodos ojales para una rápida instalación.

**Abschirmung mit Ösen.**

Gewebe mit guter Abschirmung und bequemen Ösen zur schnellen Anbringung.

Cod.	m	-	EAN	N° x	x	x	€ m <sup>2</sup>	€ m	€	€
------	---	---	-----	------	---	---	------------------	-----	---	---

<b>NEW</b>	1A180269	2.00x5		8002929125897	6	-	-	-	8,84	53,04
<b>NEW</b>	1A180270	2.00x10		8002929125903	6	-	-	-	15,11	90,66
<b>NEW</b>	1A180271	1.00x25		8002929125910	4	-	-	-	18,89	75,56
<b>NEW</b>	1A180272	1.50x25		8002929125927	4	-	-	-	27,39	109,56

## Accessori

## Accessories

## Accessoires

## Accesorios

## Zubehör

Cod.	m	-	EAN	N° x	x	x	€ m <sup>2</sup>	€ m	€	€
------	---	---	-----	------	---	---	------------------	-----	---	---

UV TREATED

**CLIPS RETE – CLIPS – CLIPS – CLIPS MALLA – KLAMMERN**
**CLIPS 35**

24 pcs	99161000	3.5 cm		8002929000569	10	77	-	-	4,13	41,30
	99160600	3.5 cm		8002929024022	500	40	-	-	0,12	60,00

**CLIPS 50**

12 pcs	1A030240	5 cm		8002929064400	12	77	-	-	2,70	32,40
12 pcs	1A140415	5 cm		8002929114563	12	77	-	-	2,70	32,40
	99168000	5 cm		8002929054999	500	-	-	-	0,14	70,00
	1A160215	5 cm		8002929120465	500	-	-	-	0,14	70,00

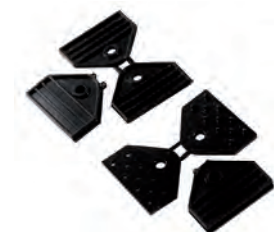
**CLIPS 100**

	99165099	8 cm		8002929024121	500	25	-	-	0,37	185,00
--	----------	------	--	---------------	-----	----	---	---	------	--------



# SUNSHINE KIT *Designed by Tenax*

185 g/m<sup>2</sup>

## Pratico e funzionale.

Kit composto da una rete tessuta a forma **triangolare o quadrata**, altamente ombreggiante, molto fitta e resistente, con bordatura di rinforzo e con anelli metallici ad ogni angolo. Si installa velocemente grazie alle corde di fissaggio incluse, che aiutano a dare al telo l'inclinazione desiderata. Di utilizzo temporaneo, a fine stagione può essere rimossa, lavata e riposta per l'anno successivo.

## Practical and functional.

A kit made up of a triangular or square woven net. It is highly shading, very thick and resistant, has reinforced edges and metal rings in every corner. It can be installed quickly thanks to its fastening ropes, which help to give the cloth the inclination desired by the user. For temporary usage, it can be removed at the end of the season to be washed and stored away for the following year.

## Pratique et fonctionnel.

Le kit se compose d'un filet tissé avec une forme triangulaire ou carrée, à haute occultation, très dense et résistant, avec bordure renforcée et avec des anneaux métalliques à chaque coin. Il s'installe rapidement grâce aux cordes de fixation incluses ; son orientation peut être modifiée facilement. D'utilisation temporaire, il peut être retiré à la fin de la saison, lavé et rangé pour l'année suivante.

## Cómodo y eficaz.

Kit compuesto por una malla tejida de forma triangular o cuadrada, con alto poder de sombreado, muy tupida y resistente, con bordes reforzados y con anillas metálicas en cada esquina. Se instala rápidamente gracias a las cuerdas de fijación incluidas que ayudan a dar a la vela la inclinación deseada. Puede lavarse y guardarse al final de la temporada.

## Praktisch und funktionell.

Das Kit besteht aus einem dreieckigen oder quadratischen Gewebe, das äußerst schattenspendend, sehr dicht und widerstandsfähig ist, mit Verstärkungsrand und Metallringen in jeder Ecke. Es ist sehr schnell installiert und durch die Befestigungsseile kann die Neigung sehr einfach verändert werden. Am Ende der Saison kann es entfernt, gewaschen und für das folgende Jahr gelagert werden.

Cod.	m	-	EAN	N° x	x	x	€ m <sup>2</sup>	€ m	€	€
1A120340	3x3x3		8002929104670	4	-	-	-	-	18,18	72,72
1A120342	3.6x3.6		8002929104694	4	-	-	-	-	39,40	157,60
1A130270	5x5		8002929109507	4	-	-	-	-	74,25	297,00



## SIEPI SINTETICHE TENAX DIVY 3D

● **Massima verosimiglianza.**  
Riproducono l'aspetto e le gradazioni di colore delle siepi naturali.

● **Foglie 3D in polietilene.**  
Piene e rigogliose, belle da vedere da tutte le angolazioni.

● **Foglie sempre belle, di lunga durata, garantite 5 anni.**  
Mantengono colore e caratteristiche nel tempo.

● **Schermano, decorano e valorizzano.**  
Per esterni ed interni, piccoli e grandi spazi, anche come elementi di design, come verde verticale e orizzontale. Creano suggestionanti pareti e trasformano qualsiasi ambiente in un'oasi di stile e relax.

DURABILITY



## TENAX DIVY 3D SYNTHETIC HEDGES

● **Maximum natural effect.**  
They reproduce the look and colouration of natural hedges.

● **3D polyethylene leaves.**  
Full and luxuriant, beautiful from any angle.

● **Always beautiful and long-lasting leaves, with a 5 year warranty.**  
They maintain their colour and features over time.

● **They screen, decorate and enhance.**  
For indoors and outdoors, small and large spaces, as design elements and as vertical and horizontal greenery. They create suggestive walls and transform any environment into an oasis of well-being and relaxation.

## HAIES SYNTHÉTIQUES TENAX 3D DIVY

● **Très forte vraisemblance.**  
Elles reproduisent l'aspect et les nuances des couleurs des haies naturelles.

● **Feuilles 3D en polyéthylène.**  
Pleines et luxuriantes, belles à regarder sous tous les angles.

● **Feuilles toujours belles, de longue durée, garanties 5 ans.**  
Elles conservent leurs couleurs et leurs caractéristiques au fil du temps.

● **Elles occultent, décorent et valorisent.**  
Pour intérieurs et extérieurs, petits et grands espaces, également comme élément de conception, tel que le vert vertical et horizontal. Elle créent des murs suggestifs et transforment n'importe quel environnement en une oasis de détente et de bien-être.

## SETOS ARTIFICIALES TENAX DIVY 3D

● **Máximo realismo.**  
Reproducen perfectamente el aspecto y las gradaciones de color de los setos naturales.

● **Hojas 3D de polietileno.**  
Llenas y frondosas, muy bonitas vistas desde cualquier perspectiva.

● **Hojas siempre bonitas, de larga durabilidad, garantizadas durante 5 años.**  
Mantienen el color y las características en el tiempo.

● **Ocultan, decoran y valorizan.**  
Para exterior e interior, pequeños y grandes espacios, incluso como elementos de diseño, como verde vertical y horizontal. Crean encantadoras paredes y transforman cualquier ambiente en un oasis de bienestar y relax.

## SYNTHETISCHE HECKEN TENAX DIVY 3D

● **Natürlicher Effekt.**  
Sie imitieren das Aussehen und die Farbabstufungen der natürlichen Hecken.

● **3D Blätter aus Polyethylen.**  
Sie sind voll und üppig, aus jedem Blickwinkel schön anzusehen.

● **Die Blätter sind immer schön, langlebig, mit 5 Jahren Garantie.**  
Sie behalten Farbe und Eigenschaften mit der Zeit bei.

● **Sie sind abschirmend, dekorativ und aufwertend.**  
Sie sind für den Innen- und Außenbereich, für kleine und große Räume, auch als Designelemente, als vertikale und horizontale Begrünung. Sie schaffen inspirierende Wände und verwandeln jede Umgebung in eine Oase des Wohlbefindens und der Entspannung.

### TENAX DIVY 3D LEAF (HDPE)



UV Resistance ★★★★★  
Natural effect ★★★★★  
Guarantee ★★★★★

### NORMAL FABRIC (PET) LEAF - NOT TENAX



UV Resistance ★☆☆☆☆  
Natural effect ★★☆☆☆  
Guarantee ★★☆☆☆

# The new vertical green

## TENAX DIVY 3D

è disponibile in tre tipologie diverse tra cui scegliere la migliore soluzione per ogni esigenza:

### ● DIVY 3D PANEL

Pannelli modulari con 7 varietà di foglia;

### ● DIVY 3D X-TENS

Tralicci estensibili in 6 varietà diverse;

### ● DIVY 3D PLUS

Photinia e Laurus installate su rete, in rotoli. Un unicum sul mercato.

## TENAX DIVY 3D is

available in three different kinds, so you can choose the best solution for any need:

### ● DIVY 3D PANEL

Modular panels with 7 types of leaves;

### ● DIVY 3D X-TENS

Extensible trellises with 6 types of leaves;

### ● DIVY 3D PLUS

Photinia and Laurus installed on net rolls. The only one on the market.

## TENAX 3D DIVY est

disponible en trois versions différentes permettant de choisir la meilleure solution en rapport à l'exigence:

### ● DIVY 3D PANEL

Panneaux modulaires avec 7 variétés de feuilles;

### ● DIVY 3D X-TENS

Treillis extensibles en 6 variétés différentes;

### ● DIVY 3D PLUS

Photinia et Laurus installés sur filet en rouleaux. Une exclusivité sur le marché.

## TENAX DIVY 3D está

disponible en tres tipos diferentes para poder elegir la mejor solución para cada exigencia:

### ● DIVY 3D PANEL

Paneles modulares con 7 tipos de hojas;

### ● DIVY 3D X-TENS

Celosías extensibles de 6 tipos diferentes;

### ● DIVY 3D PLUS

Photinia y Laurus instaladas sobre malla en rollos. Un "unicum" en el mercado.

## TENAX DIVY 3D ist in

drei unterschiedlichen Typologien erhältlich, man kann die beste Lösung für jede Anforderung wählen:

### ● DIVY 3D PANEL

Modulare Platten mit 7 Blattarten;

### ● DIVY 3D X-TENS

Dehbare Tragstrukturen in 6 unterschiedlichen Arten;

### ● DIVY 3D PLUS

Photinia und Laurus sind auf Gitter in Rollen angebracht. Ein Unikum auf dem Markt.

## TENAX DIVY 3D PANEL

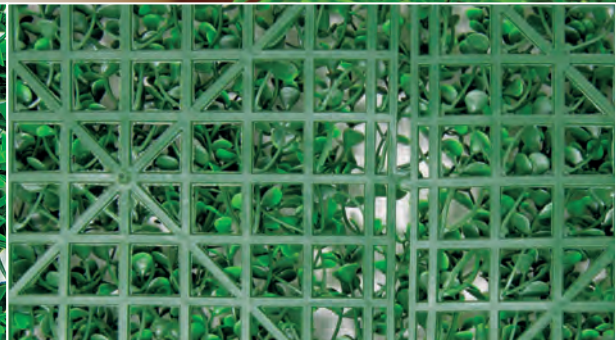
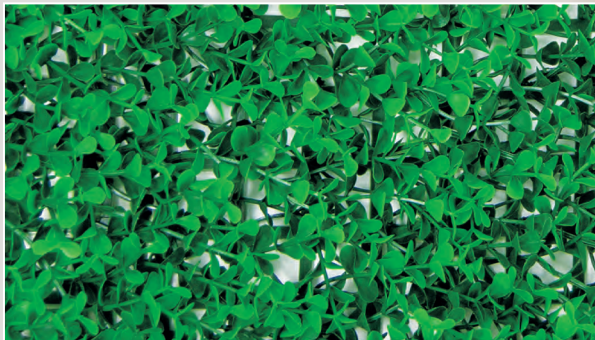

## TENAX DIVY 3D X-TENS

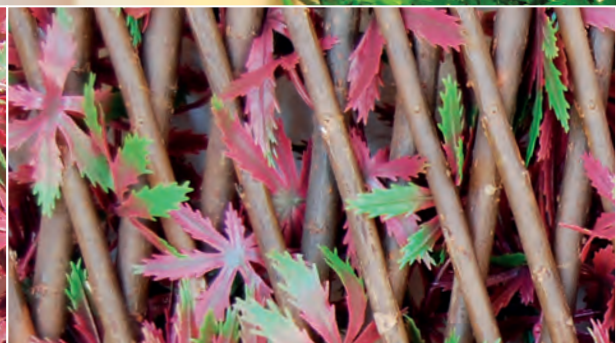

## TENAX DIVY 3D PLUS





**TENAX DIVY 3D PANEL**

In moduli da comporre a piacere per il massimo della flessibilità, altamente decorativa e di grandissimo effetto.

**TENAX DIVY 3D PANEL**

In modules to compose as you wish for maximum flexibility, highly decorative.

**TENAX DIVY 3D PANEL**

En modules à composer au choix et un maximum de flexibilité, extrêmement décorative.

**TENAX DIVY 3D PANEL**

En módulos componibles con la máxima flexibilidad, altamente decorativo con un realismo de grandísimo efecto.

**TENAX DIVY 3D PANEL**

In Modulen, die für maximale Flexibilität nach eigenen Wünschen angeordnet werden können, sehr dekorativ.

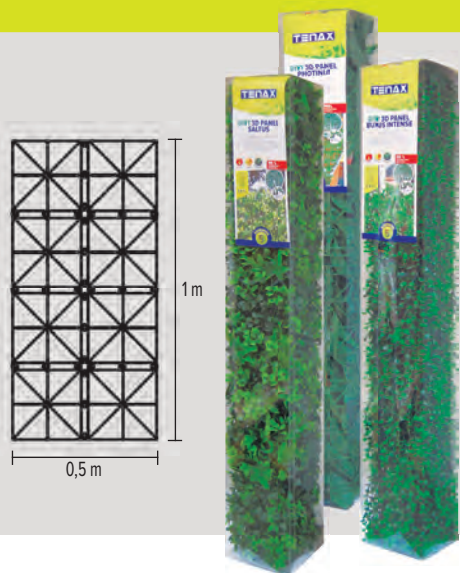

**MODULAR**

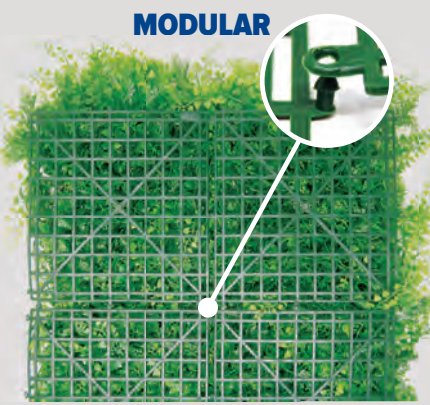

**95% SCREENING**



**DIVY 3D PANEL BUXUS LILAC**



**DIVY 3D PANEL PHOTINIA**



**DIVY 3D PANEL BUXUS**



# DIVY 3D PANEL *Designed by Tenax*



Cod.	m	-	EAN	N° x	x	x	€ m <sup>2</sup>	€ m	€	€
------	---	---	-----	------	---	---	------------------	-----	---	---

## DIVY 3D PANEL BUXUS

<b>NEW</b> 1A180285	0.50x1		8002929126054	4	-	-	-	-	23,00	92,00
---------------------	--------	--	---------------	---	---	---	---	---	-------	-------



Cod.	m	-	EAN	N° x	x	x	€ m <sup>2</sup>	€ m	€	€
------	---	---	-----	------	---	---	------------------	-----	---	---

## DIVY 3D PANEL BUXUS INTENSE

<b>NEW</b> 1A180286	0.50x1		8002929126061	4	-	-	-	-	23,00	92,00
---------------------	--------	--	---------------	---	---	---	---	---	-------	-------



Cod.	m	-	EAN	N° x	x	x	€ m <sup>2</sup>	€ m	€	€
------	---	---	-----	------	---	---	------------------	-----	---	---

## DIVY 3D PANEL BUXUS LILAC

<b>NEW</b> 1A180289	0.50x1		8002929126092	4	-	-	-	-	23,00	92,00
---------------------	--------	--	---------------	---	---	---	---	---	-------	-------

2

# DIVY 3D PANEL *Designed by Tenax*



Cod.	m	-	EAN	N° x	x	x	€ m <sup>2</sup>	€ m	€	€
------	---	---	-----	------	---	---	------------------	-----	---	---

## DIVY 3D PANEL PHOTINIA

<b>NEW</b> 1A180284	0.50x1		8002929126047	4	-	-	-	-	23,00	92,00
---------------------	--------	--	---------------	---	---	---	---	---	-------	-------



Cod.	m	-	EAN	N° x	x	x	€ m <sup>2</sup>	€ m	€	€
------	---	---	-----	------	---	---	------------------	-----	---	---

## DIVY 3D PANEL HELIX

<b>NEW</b> 1A180287	0.50x1		8002929126078	4	-	-	-	-	23,00	92,00
---------------------	--------	--	---------------	---	---	---	---	---	-------	-------



Cod.	m	-	EAN	N° x	x	x	€ m <sup>2</sup>	€ m	€	€
------	---	---	-----	------	---	---	------------------	-----	---	---

## DIVY 3D PANEL SALTUS

<b>NEW</b> 1A180283	0.50x1		8002929126030	4	-	-	-	-	23,00	92,00
---------------------	--------	--	---------------	---	---	---	---	---	-------	-------

# DIVY 3D PANEL *Designed by Tenax*

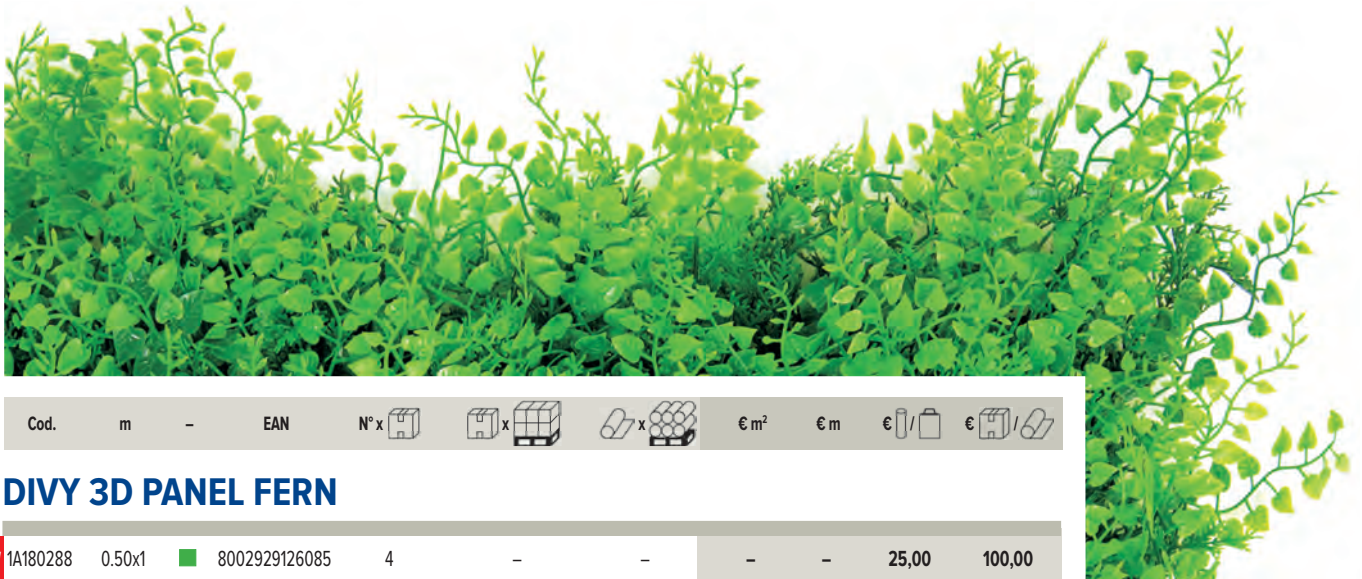

2

Cod.	m	-	EAN	N° x	x	x	€ m <sup>2</sup>	€ m	€	€
------	---	---	-----	------	---	---	------------------	-----	---	---

## DIVY 3D PANEL FERN

<b>NEW</b>	1A180288	0.50x1		8002929126085	4	-	-	-	-	25,00	100,00
------------	----------	--------	--	---------------	---	---	---	---	---	-------	--------

DIVY 3D PANEL HELIX



DIVY 3D PANEL FERN



DIVY 3D PANEL SALTUS





### TENAX DIVY 3D X-TENS

L'effetto delle foglie 3D su tralicci in salice o in PVC: facili da installare e versatili nell'utilizzo.

### TENAX DIVY 3D X-TENS

The effect of 3D leaves on willow or PVC trellises: easy to install.

### TENAX DIVY 3D X-TENS

L'effet de la feuille 3D sur treillis en saule ou en PVC: facile à installer.

### TENAX DIVY 3D X-TENS

El efecto de las hojas 3D sobre celosías de sauce o de PVC: fáciles de instalar.

### TENAX DIVY 3D X-TENS

Die Wirkung der 3D Blätter auf Tragstrukturen aus Weide oder PVC: einfach anzubringen.

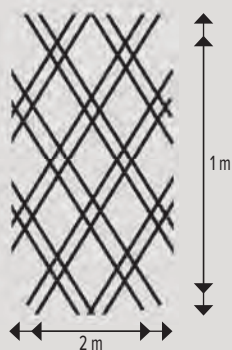

### EXTENSIBLE

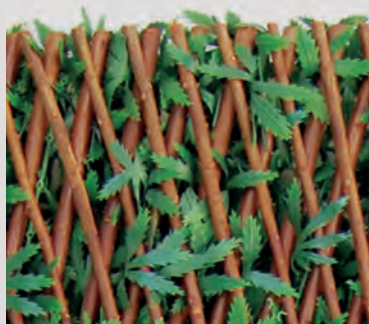

### 90% SCREENING



DIVY 3D X-TENS ACER PALMATUM



DIVY 3D TRELLIS

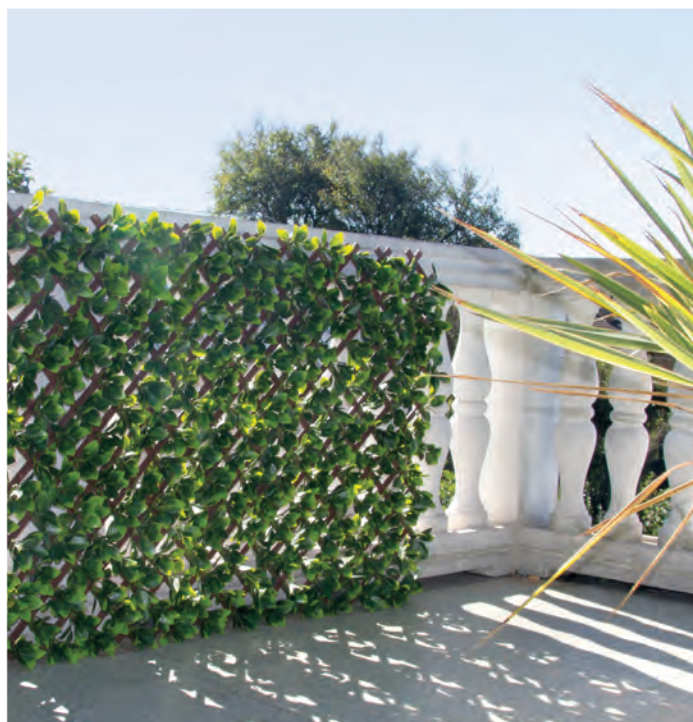



# DIVY 3D X-TENS *Designed by Tenax*



Cod.	m	-	EAN	N° x	x	x	€ m <sup>2</sup>	€ m	€	€
------	---	---	-----	------	---	---	------------------	-----	---	---

## DIVY 3D X-TENS BAMBOO

<b>NEW</b>	1A180282	1.00x2		8002929126023	4	10	-	-	-	45,00	180,00
------------	----------	--------	--	---------------	---	----	---	---	---	-------	--------

Traliccio in salice naturale – Trellis made of natural willow – Treillis en saule naturel – Enrejado de sauce natural – Struktur aus natürlicher Weide



80% SCREENING

Cod.	m	-	EAN	N° x	x	x	€ m <sup>2</sup>	€ m	€	€
------	---	---	-----	------	---	---	------------------	-----	---	---

## DIVY 3D X-TENS CYPRUS

<b>NEW</b>	1A180281	1.00x2		8002929126016	4	10	-	-	-	45,00	180,00
------------	----------	--------	--	---------------	---	----	---	---	---	-------	--------

Traliccio in salice naturale – Trellis made of natural willow – Treillis en saule naturel – Enrejado de sauce natural – Struktur aus natürlicher Weide

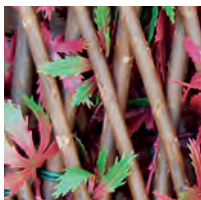

Cod.	m	-	EAN	N° x	x	x	€ m <sup>2</sup>	€ m	€	€
------	---	---	-----	------	---	---	------------------	-----	---	---

## DIVY 3D X-TENS RED ACER

<b>NEW</b>	1A180280	1.00x2		8002929126009	4	10	-	-	-	45,00	180,00
------------	----------	--------	--	---------------	---	----	---	---	---	-------	--------

Traliccio in salice naturale – Trellis made of natural willow – Treillis en saule naturel – Enrejado de sauce natural – Struktur aus natürlicher Weide

2

## DIVY 3D X-TENS *Designed by Tenax*



Cod.	m	-	EAN	N° x	x	x	€ m <sup>2</sup>	€ m	€	€
------	---	---	-----	------	---	---	------------------	-----	---	---

### DIVY 3D X-TENS ACER PALMATUM

<b>NEW</b>	1A180279	1.00x2		8002929125996	4	10	-	-	-	45,00	180,00
------------	----------	--------	--	---------------	---	----	---	---	---	-------	--------

Trallicio in salice naturale – Trellis made of natural willow – Treillis en saule naturel – Enrejado de sauce natural – Struktur aus natürlicher Weide

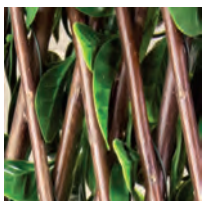

Cod.	m	-	EAN	N° x	x	x	€ m <sup>2</sup>	€ m	€	€
------	---	---	-----	------	---	---	------------------	-----	---	---

### DIVY 3D X-TENS OSMANTHUS

	1A150277	1.00x2		8002929116901	4	10	-	-	-	45,00	180,00
--	----------	--------	--	---------------	---	----	---	---	---	-------	--------

Trallicio in salice naturale – Trellis made of natural willow – Treillis en saule naturel – Enrejado de sauce natural – Struktur aus natürlicher Weide

## DIVY 3D TRELLIS *Designed by Tenax*



Cod.	m	-	EAN	N° x	x	x	€ m <sup>2</sup>	€ m	€	€
------	---	---	-----	------	---	---	------------------	-----	---	---

	1A170295	1.00x2		8002929123978	4	-	-	-	-	47,00	188,00
--	----------	--------	--	---------------	---	---	---	---	---	-------	--------

Trallicio in plastica – Plastic trellis – Treillis en plastique – Enrejado de plástico – Kunststruktur



**TENAX DIVY 3D PLUS**

Siepe molto realistica con foglie 3D artificiali simili al lauro o alla photinia, che riproducono perfettamente la siepe naturale. Le foglie sono installate su una rete in plastica a maglia quadra. **Esclusiva Tenax.**

**TENAX DIVY 3D PLUS**

Very realistic hedge with 3D artificial leaves similar to laurel or photinia, which perfectly reproduce a natural hedge. Leaves are installed on a square plastic mesh. **Tenax exclusive.**

**TENAX DIVY 3D PLUS**

Haie très réaliste avec des feuilles 3D artificielles semblables au laurier ou à la photinia, qui reproduisent parfaitement la haie naturelle. Les feuilles sont installées sur un filet en plastique à maille carrée. **Exclusivité Tenax.**

**TENAX DIVY 3D PLUS**

Seto de gran realismo con hojas 3D artificiales que imitan al laurel o a la photinia, que reproducen perfectamente el seto natural. Las hojas están instaladas sobre una malla cuadrada de plástico. **Exclusiva Tenax.**

**TENAX DIVY 3D PLUS**

Sehr realistische Hecke mit künstlichen 3D Blättern in Lorbeer oder Photinia, die die natürliche Hecke perfekt nachahmen. Die Blätter sind auf einem Kunststoffgitter mit quadratischen Maschen befestigt. **Tenax Alleinverkaufsrecht.**

**90% SCREENING**

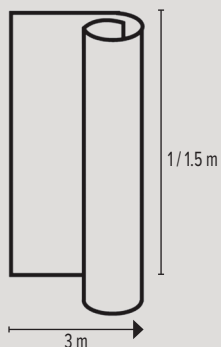

**DIVY 3D PLUS**

TOP QUALITY UV TREATED DURABILITY ROLL



Cod.	m	-	EAN	N° x	x	x	€ m <sup>2</sup>	€ m	€	€
------	---	---	-----	------	---	---	------------------	-----	---	---

**DIVY 3D PLUS LAURUS**

1A170293	1.00x3		8002929123954	2	-	-	-	-	62,90	125,80
<b>NEW</b> 1A180276	1.50x3		8002929125965	2	-	-	-	-	94,35	188,70

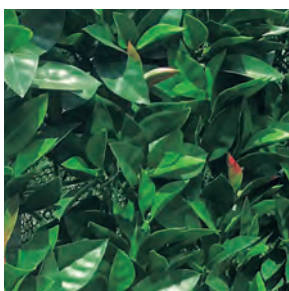

Cod.	m	-	EAN	N° x	x	x	€ m <sup>2</sup>	€ m	€	€
------	---	---	-----	------	---	---	------------------	-----	---	---

**DIVY 3D PLUS PHOTINIA**

<b>NEW</b> 1A180277	1.00x3		8002929125972	2	-	-	-	-	62,90	125,80
<b>NEW</b> 1A180278	1.50x3		8002929125989	2	-	-	-	-	94,35	188,70

2

**TENAX DIVY 2D**

Siepe artificiale con foglie 2D in poliestere.

**TENAX DIVY 2D**

Artificial hedge with polyester 2D leaves.

**TENAX DIVY 2D**

Haie artificielle avec feuilles 2D en polyester.

**TENAX DIVY 2D**

Seto artificial con hojas 2D de poliéster.

**TENAX DIVY 2D**

Synthetische Hecke mit 2D Polyesterblättern.

**DIVY X-TENS HEDERA****Traliccio decorativo estensibile.**

Traliccio estensibile in salice naturale ricoperto di edera sintetica: appoggiato a strutture di sostegno, è perfetto come schermatura di depositi, ripostigli, ingressi secondari oppure per creare divisori su balconate o in cortile.

**The ready-made decoration.**

An extendable framework covered in synthetic ivy. When combined with a support structure, it is perfect as a shield for deposits, utility rooms, back /side entrances or as a divider on balconies or in courtyards.

**Décoration immédiate.**

Réalisé en lierre synthétique monté sur un treillis extensible, ce panneau est parfait pour créer des cloisons sur les balcons ou dans les cours. Il peut décorer murs, arcades et vérandas; il sert aussi comme écran pour des dépôts, débarras ou entrées secondaires.

**Enrejado extensible.**

Recubierto de hiedra artificial: apoyado en estructuras de soporte, es perfecto como ocultación de almacenes, trasteros, entradas secundarias o también para crear separadores en balcones o patios.

**Die fertige Dekoration.**

Ein dehnbarer Spalier mit synthetischem Efeu. In Kombination mit einer Tragstruktur ist es perfekt als Sichtschutz für Lager, Lagerräume, Hinter- und Seiteneingänge oder als Verkleidung auf Balkonen oder in Innenhöfen.



Cod.	m	-	EAN	N° x	x	x	€ m <sup>2</sup>	€ m	€	€
1A100488	1.00x2		8002929094858	4	-	-	-	-	30,56	122,24



## DIVY HEDERA

**Ornamentale e resistente.**

Siepe artificiale a foglie d'edera in poliestere, sostenuta da una rete in plastica a maglia quadra. Consente di creare un effetto naturale anche nelle condizioni meno favorevoli ed in tutte le stagioni.

**Decorative and resistant.**

A new screening made of synthetic ivy leaves supported by a square plastic mesh back. It creates a natural effect even in the most unfavourable weather conditions.

**Décorative et résistante.**

Haie artificielle composée de lierre en polyester, soutenue par un filet en plastique à maille carrée qui permet de créer un effet tout à fait naturel, même dans des conditions difficiles et durant toutes les saisons.

**Decorativo y resistente.**

Seto con hojas en forma de hiedra en poliéster, sujetadas por una malla de plástico cuadrada, para crear un efecto natural incluso en las condiciones menos favorables.

**Dekorativ und beständig.**

Ein neuer Sichtschutz aus synthetischen Efeublättern durch eine quadratische Gitter-Rückseite unterstützt. Er schafft einen natürlichen Effekt, selbst bei ungünstigsten Wetterbedingungen.

Cod.	m	-	EAN	N° x	x	x	€ m <sup>2</sup>	€ m	€	€
1A100486	1.00x3		8002929094834	4	-	-	-	-	32,75	131,00
1A100487	1.50x3		8002929094841	4	-	-	-	-	49,50	198,00



Struttura di supporto in plastica – Plastic supporting structure – Structure de support en plastique – Estructura de soporte en plástico – Kunststoff-Tragstruktur

## DIVY LAURUS

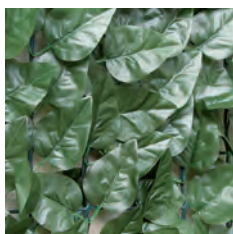
**Effetto naturale.**

Siepe artificiale composta da foglie sintetiche simili al lauro supportate da una rete in plastica a maglia quadrata, per rinnovare e decorare pergolati e terrazze.

**Natural effect.**

Artificial laurel-style hedge, supported by a square plastic mesh, DIVY LAURUS is ideal for brightening up dull areas and for decorating railings and terraces.

**Effet naturel.**

Haie artificielle composée de feuilles synthétiques semblables au laurier, soutenue par un filet à maille carrée, elle permet de rénover et de décorer pergolas et terrasses.

**Aspecto natural.**

Seto artificial compuesto por hojas sintéticas parecidas al laurel, sujetadas por una malla de plástico cuadrada, ideal para renovar y decorar vallas y balcones.

**Natürliche Wirkung.**

Künstliche Lorbeer-Hecke, unterstützt durch ein quadratisches Kunststoffnetz, ist DIVY LAURUS ideal um glanzlose Bereiche aufzuhellen und um Geländer und Terrassen zu dekorieren.

Cod.	m	-	EAN	N° x	x	x	€ m <sup>2</sup>	€ m	€	€
1A090213	1.00x3		8002929088727	4	-	-	-	-	32,75	131,00
1A090214	1.50x3		8002929088734	4	-	-	-	-	49,50	198,00
1A100489	1.00x20		8002929094865	-	-	-	12,33	12,33	-	246,60
1A100490	1.50x20		8002929094872	-	-	-	12,33	18,50	-	369,90



Struttura di supporto in plastica – Plastic supporting structure – Structure de support en plastique – Estructura de soporte en plástico – Kunststoff-Tragstruktur

# DIVY LAURUS NET

TOP QUALITY

SCREENING



**Siepe + Ombreggiante = Alta schermatura.**  
Per garantire una privacy maggiore, la siepe sintetica a foglie di lauro viene accoppiata ad una rete tessuta coprente, garantendo in tal modo sia l'effetto decorativo che la protezione da sguardi indiscreti.

**Hedge + Shading = High screening.**  
To guarantee greater privacy, the laurel synthetic hedge is coupled to a fabric mesh that covers and guarantees a decorative effect to protect against prying eyes.

**Haie + Ombrage = Grand pouvoir occultant.**  
Pour garantir une plus grande intimité, la haie synthétique à feuilles de laurier associée à un filet tissé couvrant, garantit à la fois un effet de décoration et une protection contre les regards indiscrets.

**Seto + Malla de sombra = Alta ocultación.**  
Para garantizar una mayor intimidad, el seto artificial de hojas de laurel está sujeto por una malla de plástico y una malla tejida para garantizar una ocultación completa.

**Hecke + Schattenspender = hoher Sichtschutz.**  
Um mehr Privatsphäre zu garantieren, ist die synthetische Lorbeerhecke mit einem Gewebe verbunden, das eine dekorative Wirkung sicherstellt und vor neugierigen Blicken schützt.

Cod.	m	-	EAN	N° x	x	x	€ m <sup>2</sup>	€ m	€	€
1A100484	1.00x3		8002929094810	4	-	-	-	-	35,25	141,00
1A100485	1.50x3		8002929094827	4	-	-	-	-	52,25	209,00

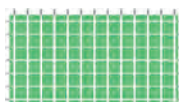

Struttura di supporto in plastica + ombreggiante – Plastic supporting structure + shading net – Structure de support en plastique + voile d'ombrage – Estructura de soporte en plástico + malla tejida – Kunststoff-Tragstruktur + Schattennetz

## DIVY LAURUS NET



## DIVY OPTIMA

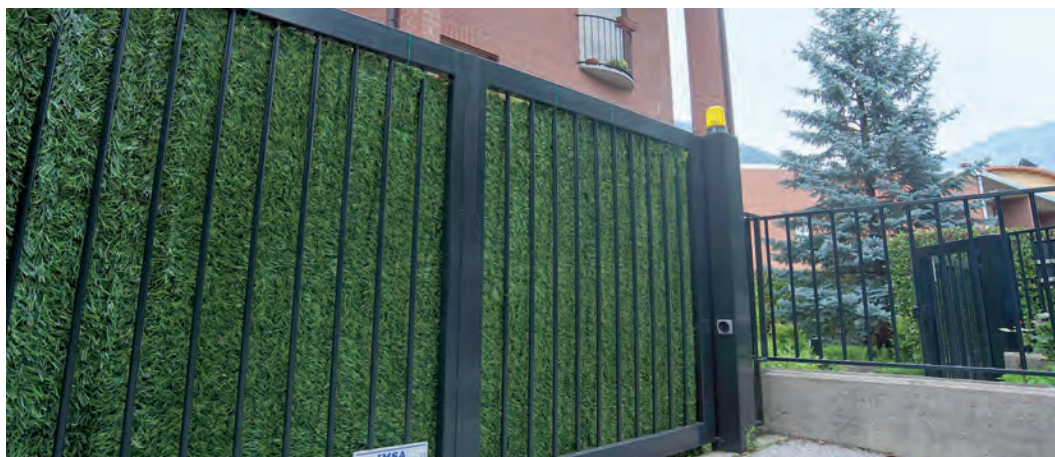

# DIVY EXTRA

TOP QUALITY

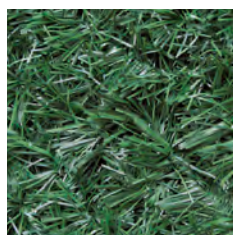

**La privacy completa.**  
Fitte frange bicolori e sottili, cucite su un'anima in filo di ferro plastificato. La particolare struttura di rinforzo con fili incrociati le conferisce una maggior resistenza, ne raddoppia l'effetto schermante e la rende molto coprente e di lunga durata.

**Total privacy.**  
DIVY EXTRA offers a high screening effect, due to the close-knit fine fringes in two different shades of green. Supported by a diagonal wire structure that doubles the density of the hedge as well as its screening power.

**Complète intimité.**  
Haie composée de fines franges abondantes, de deux couleurs différentes, doublant sa capacité d'occultation pour une occultation totale. Sa structure croisée en fil de fer plastifié lui garantit une longue durée dans le temps.

**Máxima intimidación.**  
Seto artificial de alta ocultación, con flecos finos bicolor muy tupidos, unidos a una estructura de alambre plastificado tipo celosía que garantiza una larga durabilidad.

**Absolute Privatsphäre.**  
DIVY EXTRA bietet eine hohe Abschirmwirkung aufgrund der fest verbundenen feinen Fransen in zwei verschiedenen Grüntönen. Unterstützt durch eine diagonale Drahtstruktur, welche die Dichte der Hecke sowie ihren Sichtschutz verdoppelt.

Cod.	m	-	EAN	N° x	x	x	€ m <sup>2</sup>	€ m	€	€
1A090215	1.00x3		8002929088741	2	15	-	-	-	32,00	64,00
1A090216	1.50x3		8002929088758	2	15	-	-	-	48,15	96,30



Struttura di supporto in filo di ferro plastificato – Plastic-coated wire supporting structure – Structure de support en fil de fer plastifié – Estructura de soporte en alambre de hierro plastificado – Kunststoff beschichtete Drahttragstruktur

# DIVY OPTIMA

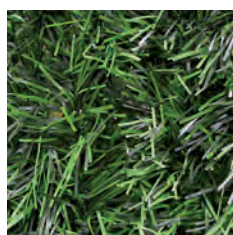

**Semplice e pratica.**  
Per schermare giardini e cortili, una siepe sintetica a frange bicolori cucite su un'anima in filo di ferro plastificato che si fissa facilmente a recinzioni e cancellate.

**Easy to use.**  
Used to screen gardens and courtyards, DIVY OPTIMA is an artificial hedge with thin fringes in two colours, sewn onto a wire base. Easy to install and washable.

**Simple et pratique.**  
Haie synthétique composée de franges larges de deux couleurs, cousue sur une structure en fil de fer plastifié qui se fixe facilement sur les clôtures et les portails.

**Simple y práctico.**  
Para proteger la intimidación de jardines y patios, un seto artificial con flecos finos bicolor cosidos a un alambre plastificado. Se instala fácilmente sobre cercados y vallas.

**Einfach in der Anwendung.**  
DIVY OPTIMA ist eine künstliche Hecke mit dünnen Fransen in zwei Farben die auf einem Drahtgerüst fixiert sind. Damit werden Gärten und Höfe abgeschirmt. Einfach zu installieren und abwaschbar.

Cod.	m	-	EAN	N° x	x	x	€ m <sup>2</sup>	€ m	€	€
1A120326	1.00x3		8002929104533	2	24	-	-	-	19,25	38,50
1A120327	1.50x3		8002929104540	2	-	-	-	-	28,75	57,50
1A150076	2.00x3		8002929115249	2	-	-	-	-	38,50	77,00



Struttura di supporto in filo di ferro plastificato – Plastic-coated wire supporting structure – Structure de support en fil de fer plastifié – Estructura de soporte en alambre de hierro plastificado – Kunststoff beschichtete Drahttragstruktur

## Cannicci sintetici

Il bambù imputridisce velocemente e ospita insetti. In alternativa TENAX propone i **cannicci sintetici**: resistono al vento ed agli agenti atmosferici, non hanno bisogno di manutenzione e durano diversi anni.

## Synthetic reeds

TENAX **synthetic reeds** provide an excellent alternative to natural screening, as natural bamboo has a tendency to rot and attract irritating insects. Tenax **synthetic reeds** are resistant to wind and weather elements and will last for years.

## Cannes synthétiques

Les bambous synthétiques sont parfaits dans toutes les situations, simples à installer, ils fournissent un écran à la fois protecteur et décoratif, avec une bonne résistance au vent et aux agents atmosphériques. Ils n'exigent aucun entretien... pérennité garantie.

## Cañizos artificiales

El mimbre se pudre rápidamente albergando además insectos molestos. Como alternativa, TENAX ofrece una gama de cañizos sintéticos: resistentes al viento y a los agentes atmosféricos, no necesitan ningún tipo de mantenimiento y son de larga duración.

## Synthetische Schilfe

TENAX synthetische Schilfe bieten eine hervorragende Alternative zum natürlichen Sichtschutz, da natürlicher Bambus zu vermodern und zum Anlocken unangenehmer Insekten neigt. Tenax synthetische Schilfe sind resistent gegen Wind, wetterfest und über Jahre haltbar.

## COLORADO *Designed by Tenax*

UV TREATED

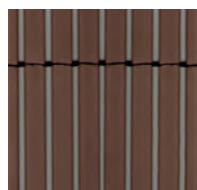
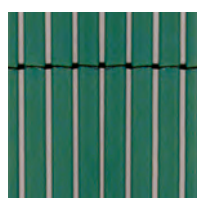

### Canniccio ad imitazione naturale.

Arella composta da sottili canne sintetiche che ricordano quelle in bambù o in salice. Bello da entrambe le parti poiché bifacciale, è un canniccio economico che non rinuncia ad un alto appeal visivo.

### Natural looking reed screen.

Cane composed of light synthetic reeds, similar to bamboo or willow. Beautiful from both sides as it is double-faced, this inexpensive reed does not lose any of its visual appeal.

### Canisse à imitation naturelle.

Canisse double face, composée de fines cannes synthétiques évoquant le bambou ou le saule. Élégante, c'est une canisse économique qui ne renonce pas à l'attrait esthétique.

### Cañizo de aspecto natural.

Estructura compuesta de finas cañas sintéticas parecidas al bambú o al mimbre. Decorativo por las dos caras, es un cañizo elegante que ofrece un gran atractivo visual.

### Natürlich aussehendes Schilf.

Das Schilf bestehend aus leichten synthetischen Schilfrohren, ähnlich wie Bambus oder Weide. Durch die doppelseitige Struktur von beiden Seiten optisch sehr ansprechend.

Cod.	m	-	EAN	N° x	x	x	€ m <sup>2</sup>	€ m	€	€
1A130275	1.00x5		8002929109552	2	21	-	-	-	29,52	59,04
1A140384	1.00x5		8002929114273	2	21	-	-	-	29,52	59,04
1A140267	1.00x5		8002929113245	2	21	-	-	-	29,52	59,04
1A130277	1.00x5		8002929109576	2	21	-	-	-	29,52	59,04
1A150217	1.00x5		8002929116482	2	21	-	-	-	29,52	59,04
1A130276	1.50x5		8002929109569	2	21	-	-	-	43,56	87,12
1A140385	1.50x5		8002929114280	2	21	-	-	-	43,56	87,12
1A140268	1.50x5		8002929113252	2	21	-	-	-	43,56	87,12
1A130315	1.50x5		8002929109958	2	21	-	-	-	43,56	87,12
1A150216	1.50x5		8002929116475	2	21	-	-	-	43,56	87,12
1A150214	2.00x5		8002929116451	2	21	-	-	-	58,09	116,18
1A150215	2.00x5		8002929116468	2	21	-	-	-	58,09	116,18
1A150213	2.00x5		8002929116444	2	21	-	-	-	58,09	116,18



## NILO PLUS

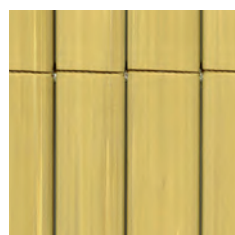

**Alta qualità a canna intera.**  
Per una schermatura totale e decorativa, canniccio sintetico a canna legate ed incollate singolarmente con filo di nylon, **affinché non si sfilaccino in caso di tagli.**

**High quality with whole cane.**  
For total and decorative screening, this is a synthetic reed screen with canes that are individually tied with nylon thread and then glued so that they do not unravel if the screen is cut.

**Canne entière de haute qualité.**  
Pour une occultation totale et décorative, une canisse synthétique aux tiges liées et collées individuellement avec du fil de nylon, de sorte qu'elles ne s'effilochent pas au moment de la coupe.

**Alta calidad de caña entera.**  
Para una ocultación total y decorativa, un cañizo artificial con cañas atadas y pegadas individualmente con hilo de nylon para que no se deshilachen en caso de cortes.

**Hohe Qualität mit ganzen Schilfrohren.**  
Ein synthetisches Schilf zur vollständigen und dekorativen Abschirmung, bestehend aus einzeln mit Nylonfäden verbundenen und verklebten Schilfrohren, damit sie im Falle von Schnitten nicht ausfransen.



Cod.	m	-	EAN	N° x	x	x	€ m <sup>2</sup>	€ m	€	€
1A070120	1.00x3		8002929028273	-	-	20	-	-	-	23,98
1A070123	1.00x3		8002929028266	-	-	20	-	-	-	23,98
1A070502	1.50x3		8002929082503	-	-	20	-	-	-	35,97
1A070501	1.50x3		8002929082497	-	-	20	-	-	-	35,97
1A070122	2.00x5		8002929068873	-	-	12	-	-	-	79,98
1A070125	2.00x5		8002929068880	-	-	12	-	-	-	79,98

## NILO PLUS



## COLORADO



RIO

UV TREATED



INEXPENSIVE



**Mezza canna.**  
Canniccio mono vista  
in PVC, più leggero,  
è ideale per  
delimitare aree di  
lavoro e magazzino  
ad un ottimo rapporto  
qualità-prezzo.

**Half cane reed.**  
Single sided PVC  
reed, lighter and  
more cost effective,  
is ideal for delimiting  
work and storage  
areas.

**Demi canne.**  
Canisse face unique  
en PVC, plus légère  
et économique,  
elle est idéale pour  
délimiter les aires de  
travail et les dépôts  
à un très bon rapport  
qualité-prix.

**Caña media.**  
Cañizo artificial de  
media caña en PVC.  
Ideal para cercar  
zonas de trabajo y  
de almacén.

**Halb-Schilfrohr.**  
Einseitiges PVC  
Schilf, leichter und  
kostengünstiger,  
ideal für die  
Abgrenzung  
von Arbeits- und  
Lagerbereichen.

Cod.	m	-	EAN	N° x	x	x	€ m <sup>2</sup>	€ m	€	€
1A150184	1.00x5		8002929116260	2	28	-	-	-	25,98	51,96
1A150181	1.00x5		8002929116239	2	28	-	-	-	25,98	51,96
1A150182	1.20x5		8002929116246	2	-	-	-	-	31,18	62,36
1A120353	1.50x5		8002929104816	2	28	-	-	-	39,02	78,04
1A120352	1.50x5		8002929104809	2	28	-	-	-	39,02	78,04
1A150183	1.80x5		8002929116253	2	28	-	-	-	46,76	93,52



## Accessori

## Accessories

## Accessoires

## Accesorios

## Zubehör

Cod.	m	-	EAN	N° x	x	x	€ m <sup>2</sup>	€ m	€	€
------	---	---	-----	------	---	---	------------------	-----	---	---

## FASCETTE PER CANNICCI – CANE SCREEN TIES – LIENS POUR CANNISSES – BRIDAS CAÑIZO – SCHILFROHR-BEFESTIGUNGEN

Confezione da 26 pezzi – Pack of 26 pieces – Sachet de 26 pièces – Envasado en bolsas de 26 unidades – Packung mit 26 Stk.



1A150506	0.15		8002929104878	25	-	-	-	-	3,26	81,50
1A150507	0.15		8002929104861	25	-	-	-	-	3,26	81,50



**PRATI SINTETICI,  
SALVAPRATO**

**SYNTHETIC LAWNS,  
LAWN  
REINFORCEMENT**

**GAZONS  
SYNTHÉTIQUES,  
GRILLES  
POUR SOLS**

**CÉSPEDES  
ARTIFICIALES,  
PROTECCIÓN  
DEL CÉSPED**

**KUNSTRASEN,  
RASENGITTER**

Prati sintetici	Synthetic lawns	Gazons synthétiques	Céspedes artificiales	Kunstrasen	74
Salvaprato	Lawn reinforcement	Grilles pour sols	Protección del césped	Rasengitter	81

**PRATI  
SINTETICI**

In ogni stagione sono sempre verdissimi e rigogliosi, senza bisogno di falciare e irrigare. Non attirano zanzare o altri insetti e resistono a sale e cloro. Disponibili in tipologie, diverse per lunghezza e tonalità dell'erba, i prati sintetici si possono utilizzare dentro e fuori casa. Dove: prati, terrazzi, balconi, aiuole, bordo piscina, sopra tetti o pensiline, come tappeto o passatoia per comunità e aree esterne di locali pubblici quali ristoranti e hotel.

**Ideali dove giocano bambini e animali domestici.**

**SYNTHETIC  
LAWNS**

They are always green and luxuriant in every season, without having to mow or water them. They do not attract mosquitoes or other insects and resist salt and chlorine. Different types of synthetic lawns, which vary in grass length and shade, are available. They can be used both indoors and outdoors. Where: lawns, terraces, balconies, flowerbeds, poolside, on roofs or projecting roofs, as carpet or runner for outdoor areas of public places such as restaurants and hotels.

**Ideal where children and pets play.**

**GAZONS  
SYNTHÉTIQUES**

À toute saison, ils sont toujours très verts et luxuriants, sans besoin d'être tondus, scarifiés ou arrosés. Ils n'attirent ni les moustiques ni les autres insectes et résistent au sel et au chlore. Une ligne complète de gazons qui diffèrent quant à la longueur et l'épaisseur de l'herbe, la couleur et les nuances d'ombre pouvant être utilisés aussi bien à l'intérieur qu'à l'extérieur de la maison. Où donc ? : sur les pelouses, les terrasses, les balcons, les parterres de fleurs, près de la piscine, au-dessus des toits ou des abris, en tant que tapis pour les communautés et les espaces extérieurs des lieux publics tels que les restaurants et les hôtels.

**Idéals dans les aires de jeux d'enfants et d'animaux domestiques.**

**CÉSPEDES  
ARTIFICIALES**

Siempre verdes y vigorosos en todas las estaciones, no es necesario cortarlos o regarlos. No atraen mosquitos u otros insectos y son resistentes a la sal y al cloro. Disponibles en varios tipos, diferenciados por alturas y colores de hierba distintos, los céspedes artificiales se pueden utilizar tanto en interior como en exterior. Donde: jardines, terrazas, balcones, parterres, alrededores de piscinas, azoteas o porches, como alfombra para comunidades y zonas externas de locales públicos como restaurantes y hoteles.

**Ideales donde juegan niños y animales domésticos.**

**KUNSTRASEN**

Sie sind zu jeder Jahreszeit immer grün und üppig, man muss nicht mähen und bewässern. Sie ziehen keine Mücken oder andere Insekten an und sind Salz- und Chlorbeständig. Die Kunstrasen sind in verschiedenen Typen erhältlich, die sich in Länge und Grasfarbe unterscheiden, sie können sowohl im Innen- als auch im Außenbereich verwendet werden. Wo: Rasen, Terrassen, Balkone, Beete, am Rand von Schwimmbecken, auf Dächern oder Vordächern, als Teppich oder Läufer für Gemeinschafts- und Außenbereiche von öffentlichen Lokalen wie Restaurants oder Hotels.

**Ideal dort wo Kinder und Haustiere spielen.**



VIDEO TUTORIAL



UV TREATED



WONDERFUL  
IN ALL SEASONS



CHLORINE & SALT  
RESISTANT



NO  
WASTED WATER



LOVE  
BABIES & PETS



3

DURABILITY



## Le ragioni per scegliere TENAX Irish Mat

- **Garanzia 8 anni.**
- **Massima verosimiglianza** 4 colori per un effetto ancora più naturale.
- **Finitura MAT** per ridurre l'effetto lucido.
- **Alta qualità** HDPE e PP 100% vergini senza metalli pesanti.
- **Morbidezza al tatto.**
- **Alta resistenza** allo strappo e al calpestio.
- **Alta densità dei fili** per un aspetto "ricco".
- **Forma "Spine Shape"** che permette una ottimale gestione del calore.
- **Spessore del filo** che simula l'erba vera.
- **Memoria di forma** così il prodotto torna facilmente in posizione eretta.
- **Fori di drenaggio** La capacità drenante è di 60 l al m<sup>2</sup> per ogni minuto.
- **Filaturo in linea** che permette di ridurre la possibilità di strappo.
- **Backing di alta qualità** per un perfetto ancoraggio del filo.
- **Facile installazione** grazie al tutorial Tenax.
- **Facile manutenzione** Bastano un soffiatore, acqua e sapone neutro.
- **Accessori Tenax** Un set completo per l'installazione.

## The reasons to choose TENAX Irish Mat

- **8 year warranty.**
- **Maximum natural effect.** 4 colours for an even more natural effect.
- **MAT design** to reduce the shine effect.
- **High-quality material** 100% virgin HDPE and PP without heavy metals.
- **Softness.**
- **Highly tear and trample resistant.**
- **Dense threads** for a "rich" appearance.
- **"Spine Shape"** which enables an optimal heat management.
- **Thread thickness** like real grass.
- **Shape memory** so the product returns upright easily.
- **Drainage holes** The drainage capacity is 60 l/m<sup>2</sup> per minute.
- **In-line stitching** that increases tear resistance.
- **High-quality backing** for a perfect anchoring of the thread.
- **Easy installation** thanks to our Tenax tutorial.
- **Easy maintenance** You just need a blower, water and neutral soap.
- **Tenax accessories** A complete set for installation.

## Les raisons pour choisir TENAX Irish Mat

- **8 ans de garantie.**
- **Vraisemblance maximale** 4 couleurs pour un effet encore plus brillant.
- **Conception MAT** pour réduire l'effet brillant.
- **Matériaux de haute qualité** en PEHD et PP 100% vierges sans métaux lourds.
- **Doux au toucher.**
- **Haute résistance** à la déchirure et au piétinement.
- **Densité de fil élevée** pour une apparence "riche".
- **Forme "Spine Shape"** qui permet une gestion optimale de la chaleur.
- **Épaisseur du fil** qui simule l'herbe réelle.
- **Mémoire de forme** Ainsi, le produit revient facilement à la verticale.
- **Trous de drainage** La capacité de drainage est de 60 litres/m<sup>2</sup>/minute.
- **Filage en ligne** réduisant les risques de déchirure.
- **Support de haute qualité** pour un ancrage parfait du fil.
- **Installation facile** grâce au tutoriel Tenax.
- **Facilité d'entretien** Un ventilateur, de l'eau et du savon neutre suffisent.
- **Accessoires Tenax** Un ensemble complet pour l'installation.

## Los motivos para elegir TENAX Irish Mat

- **Garantía 8 años.**
- **Máximo realismo** 4 colores para un efecto aún más natural.
- **Diseño MAT** para reducir el efecto brillante.
- **Alta calidad del material** HDPE y PP 100% vírgenes sin metales pesados.
- **Suaves al tacto**
- **Alta resistencia** a la rotura y a las pisadas.
- **Alta densidad de los hilos** para un aspecto "rico".
- **Forma "Spine Shape"** que permite una óptima gestión del calor.
- **Grosor del hilo** que imita a la hierba natural.
- **Memoria de forma** Así el producto vuelve fácilmente a su posición recta.
- **Agujeros de drenaje** La capacidad drenante es de 60 l al m<sup>2</sup> por minuto.
- **Hilado en línea** que permite reducir la posibilidad de desgarrar.
- **Backing de alta calidad** para un perfecto anclaje del hilo.
- **Fácil instalación** gracias al tutorial Tenax.
- **Fácil mantenimiento** Es suficiente un soplador, agua y jabón neutro.
- **Accesorios Tenax** Una serie completa para la instalación.

## Gründe um TENAX Irish Mat zu wählen

- **8 Jahre Garantie.**
- **Sehr realistisches Erscheinungsbild** 4 Farben für einen noch natürlicheren Effekt.
- **MAT Konzipiert** um den Glanzeffekt zu reduzieren.
- **Hochwertiges Material** 100% reines HDPE und PP ohne Schwermetalle.
- **Weich anzufassen.**
- **Hohe Beständigkeit** gegen Risse und Getrampel.
- **Hohe Dichte der Halme** für einen "reichen" Anblick.
- **"Spine Shape"** Form für eine optimale Wärmeleitung.
- **Dicke der Halme** simuliert echtes Gras.
- **Formgedächtnis** somit geht das Produkt leicht wieder in die aufrechte Position zurück.
- **Drainagelöcher** die Drainagefähigkeit liegt bei 60 l pro m<sup>2</sup> pro Minute.
- **In einer Reihe gesponnen** was die Reisswahrscheinlichkeit reduziert.
- **Hochwertiges Backing** zur perfekten Verankerung des Fadens.
- **Einfache Anbringung** dank des Tenax Tutorials.
- **Einfache Pflege** dazu reichen ein Laubbläser, Wasser und neutrale Seife.
- **Tenax Zubehörteile** ein komplettes Set für den Aufbau.



Morbidezza – Softness – Douceur – Blandura – Weichheit



Verosimiglianza – Similarity – Imitation parfaite – Semejanza – Ähnlichkeit



Densità e altezza filo – Density and yarn height – Densité et hauteur de la fibre – Densidad y altura de hilo – Dichte und Fadenhöhe



Resistenza al calpestio – Trampling resistance – Résistance au piétinement – Resistencia al pisoteo – Widerstand gegen Trampeln



**TENAX merchandising:**  
a support for product sales!





**Prati  
sintetici**

**Synthetic  
lawns**

**Gazons  
synthétiques**

**Céspedés  
artificiales**

**Kunstrasen**

**3**



4 colours

## IRISH MAT 42 *Designed by Tenax*



**Alto e compatto.**  
IRISH MAT 42 è il top di gamma per verosimiglianza ed effetto visivo. Ad altissima densità (**16.800 fili per m<sup>2</sup>, 2.950 g/m<sup>2</sup>**), con fibre alte (**40 mm**) e compatte risulta estremamente soffice e rigoglioso, perfetto per creare soluzioni architettoniche innovative (terrazzi, balconi, pensiline, bocche di lupo, bordi piscina) oltre al tradizionale giardino.

**Tall and compact.**  
IRISH MAT 42 is the top of the line due to its natural effect and appearance. It has very high density (**16,800 yarns per m<sup>2</sup>, 2,950 g/m<sup>2</sup>**). Its tall (**40 mm**) and compact fibres make it extremely soft and luxuriant, perfect for creating innovative architectural solutions (terraces, balconies, projecting roofs, basement windows, poolsides), in addition to traditional gardens.

**Haut et compact.**  
IRISH MAT 42 est le haut de gamme pour sa vraisemblance et son effet visuel. À très haute densité (**16.800 fils par m<sup>2</sup>, 2.950 g/m<sup>2</sup>**), avec des fibres longues (**40 mm**) et compactes, il est extrêmement doux et luxuriant, parfait pour créer des solutions architecturales innovantes (terrasses, balcon, haut vents, soupiraux, bords de piscine), outre le jardin traditionnel.

**Alto y compacto.**  
IRISH MAT 42 es el tope de gama por su realismo y efecto visual. De altísima densidad (**16.800 hilos por m<sup>2</sup>, 2.950 g/m<sup>2</sup>**), con fibras altas (**40 mm**) y compactas, resulta extremadamente suave y frondoso, perfecto para crear soluciones arquitectónicas innovadoras (terrazas, balcones, porches, sumideros, alrededores de piscinas) además del tradicional jardín.

**Hoch und kompakt.**  
IRISH MAT 42 ist der Serienbeste im Bereich Natürlichkeit und Aussehen. Mit sehr hoher Dichte (**16.800 Fäden pro m<sup>2</sup>, 2.950 g/m<sup>2</sup>**), mit hohen (**40 mm**) und kompakten Fasern erweist er sich als extrem weich und üppig, perfekt um, abgesehen vom traditionellen Garten, innovative architektonische Lösungen zu schaffen (Terrassen, Balkone, Dachgärten, Kellerfenster, Schwimmbäder).

Cod.	m	-	EAN	N° x	x	x	€ m <sup>2</sup>	€ m	€	€
1A130278	2.00x10		8002929109583	-	-	-	27,00	54,00	-	540,00
1A120500	2.00x25		8002929105974	-	-	-	27,00	54,00	-	1.350,00

## IRISH MAT 25 *Designed by Tenax*

DURABILITY

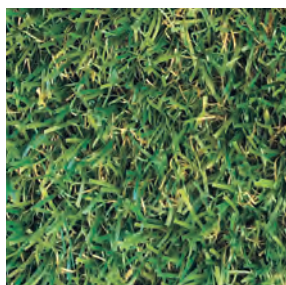

4 colours

**Ottimo rapporto qualità prezzo.** IRISH MAT 25 con fibre di altezza media (**23 mm**) è il prato dall'ottimo rapporto qualità-prezzo ad alta verosimiglianza (**12.600 fili per m<sup>2</sup>, 1.850 g/m<sup>2</sup>**). Consigliato per locali pubblici ed alberghi, è estremamente resistente al calpestio.

**Excellent value for money.** IRISH MAT 25 has medium-height fibres (**23 mm**). This lawn is very cost-effective and provides a great natural effect (**12,600 yarns per m<sup>2</sup>; 1,850 g/m<sup>2</sup>**). Recommended for public places and hotels, it is extremely trample resistant.

**Excellent rapport qualité/prix.** IRISH MAT 25, avec des fibres de hauteur moyenne (**23 mm**), est le gazon avec un excellent rapport qualité-prix, à très forte vraisemblance (**12.600 fils par m<sup>2</sup>, 1.850 g/m<sup>2</sup>**). Recommandé pour les lieux publics et les hôtels, il est extrêmement résistant au piétinement.

**Excelente relación calidad-precio.** IRISH MAT 25 con fibras de altura media (**23 mm**) es el césped con una óptima relación calidad precio de alto realismo (**12.600 hilos por m<sup>2</sup>, 1.850 g/m<sup>2</sup>**). Recomendado para locales públicos y hoteles, es extremadamente resistente a las pisadas.

**Ausgezeichnetes Preis-Leistungs-Verhältnis.** IRISH MAT 25 mit mittelhohen Fasern (**23 mm**) ist ein Rasen mit einem optimalen Preis-Leistungs-Verhältnis und echter Wirkung (**12.600 Fäden pro m<sup>2</sup>, 1.850 g/m<sup>2</sup>**). Er wird für öffentliche Lokale und Hotels empfohlen und ist extrem trittbeständig.

Cod.	m	-	EAN	N° x	x	x	€ m <sup>2</sup>	€ m	€	€
<b>NEW</b> 1A180384	1.00x5		8002929126696	-	-	-	-	-	-	<b>78,75</b>
<b>NEW</b> 1A180420	1.00x5		8002929126696	18 Promobox	1	-	-	-	<b>78,75</b>	<b>1.417,50</b>
1A150219	2.00x4		8002929116505	-	-	-	-	-	-	<b>126,00</b>
1A140387	1.00x25		8002929114303	-	-	-	<b>15,00</b>	<b>15,00</b>	-	<b>375,00</b>
1A150218	2.00x10		8002929116499	-	-	-	<b>15,00</b>	<b>30,00</b>	-	<b>300,00</b>
1A140388	2.00x25		8002929114310	-	-	-	<b>15,00</b>	<b>30,00</b>	-	<b>750,00</b>

## IRISH MAT 20 *Designed by Tenax*

DURABILITY



4 colours

**Per ampie superfici.** IRISH MAT 20 a prezzo contenuto, con fibre meno lunghe (**18 mm**) ma dall'aspetto naturale. Ha una buona densità (**13.650 fili per m<sup>2</sup>, 1.770 g/m<sup>2</sup>**) ed è indicato anche per aree molto estese.

**Wide surfaces.** IRISH MAT 20 is inexpensive, has shorter fibres (**18 mm**) but they seem natural. It has good density (**13,650 yarns per m<sup>2</sup>; 1,770 g/m<sup>2</sup>**) and is suitable for very large areas too.

**Grandes superficies.** IRISH MAT 20, à un prix raisonnable, avec des fibres moins longues (**18 mm**) mais à l'aspect naturel. De bonne densité (**13.650 fils par m<sup>2</sup>, 1.770 g/m<sup>2</sup>**) il est recommandé pour les très grandes surfaces.

**Grandes áreas.** IRISH MAT 20 de precio asequible, con fibras menos largas (**18 mm**) pero de aspecto natural. Tiene una buena densidad (**13.650 hilos por m<sup>2</sup>, 1.770 g/m<sup>2</sup>**) y está indicado también para áreas muy amplias.

**Große Flächen.** IRISH MAT 20 ist preiswert, hat kürzere Fasern (**18 mm**) und wirkt natürlich. Er hat eine gute Dichte (**13.650 Fäden pro m<sup>2</sup>, 1.770 g/m<sup>2</sup>**) und ist auch für sehr große Flächen geeignet.

Cod.	m	-	EAN	N° x	x	x	€ m <sup>2</sup>	€ m	€	€
<b>NEW</b> 1A180303	1.00x3		8002929127044	-	-	-	-	-	-	<b>36,23</b>
<b>NEW</b> 1A180421	1.00x3		8002929127044	35 Promobox	-	-	-	-	<b>36,23</b>	<b>1.267,88</b>
<b>NEW</b> 1A180305	2.00x10		8002929126191	-	-	-	<b>11,50</b>	<b>23,00</b>	-	<b>230,00</b>
<b>NEW</b> 1A180306	2.00x25		8002929126207	-	-	-	<b>11,50</b>	<b>23,00</b>	-	<b>575,00</b>



# STANDARD GREEN

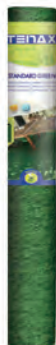

## Il tappeto verde.

Stuoia in fibre sintetiche a "pelo raso", è generalmente usata per decorare ingressi, pavimentazioni esterne e balconi.

## The green carpet.

With its mat made up of "short cut" synthetic fibres, STANDARD GREEN is generally used to decorate entrances, outdoor flooring and balconies.

## Le tapis vert.

Tapis en fibres synthétiques à "poil court", il est généralement utilisé pour décorer les entrées, les balcons et les sols extérieurs.

## La moqueta verde.

Esterilla de fibras sintéticas de pelo corto. Indicado generalmente para decorar entradas y superficies exteriores en terrazas y balcones.

## Der grüne Teppich.

Mit der Matte, die aus „kurzgeschnittenen“ synthetischen Fasern hergestellt ist, wird STANDARD GREEN im Allgemeinen zum Dekorieren von Eingängen, Außenbereichböden und Balkonen verwendet.

Cod.	m	-	EAN	N° x	x	x	€ m <sup>2</sup>	€ m	€	€
1A120489	1.00x4		8002929105875	-	-	-	-	-	-	26,04
1A120649	1.00x4		8002929105875	24 Promobox	1	-	-	-	26,04	624,96
1A130410	1.00x25		8002929110756	-	-	12	5,15	5,15	-	128,75
1A130411	2.00x25		8002929110763	-	-	6	5,15	10,30	-	257,50

### IRISH MAT 42



### IRISH MAT 20



### IRISH MAT 25



## Accessori

## Accessories

## Accessoires

## Accesorios

## Zubehör

Cod.	m	-	EAN	N° x 	 x 	 x 	€ m <sup>2</sup>	€ m	€ 	€ 
------	---	---	-----	--	--	---	------------------	-----	---	---

### 3 FULL COVER

Tessuto antierbacce – Fabric for mulching – Tissu anti mauvaises herbes – Tejido antihierbas – Unkrautbekämpfung gewebe

100 g/m<sup>2</sup>

73004309	1.80x50	■	8002929012913	-	-	30	1,40	2,52	-	126,00
----------	---------	---	---------------	---	---	----	------	------	---	--------

Altre misure a pagina - Other measures at page - Autres mesures voir page - Otras medidas en la página - Andere Maßnahmen auf der Seite **99**

### 3 MAT STRIPE

Nastro di giunzione in tessuto non tessuto (da utilizzare con colla) – Connecting non-woven tape (using glue) – Ruban de jointement (à l'aide d'une colle) – Banda de unión (mediante el uso de cola) – Band aus Vliesstoff mit Klebstoff zu verwenden



1A100491	0.23x20	□	8002929094889	4	48	-	-	-	11,55	46,20
----------	---------	---	---------------	---	----	---	---	---	-------	-------

### 3 MAT SEAL

Nastro di giunzione monoadesivo – Single-sided adhesive connecting tape – Ruban mono-adhésif de jointure – Cinta de unión mono adhesiva – Einzelklebendverbindungsband



1A140240	0.15x10	■	8002929110046	4	-	-	-	-	52,50	210,00
----------	---------	---	---------------	---	---	---	---	---	-------	--------

### 3 MAT DUO

Nastro biadesivo bituminoso – Bi-adhesive bituminous tape – Ruban bi-adhésif bitumeux – Cinta biadhesiva bituminosa – Bituminös doppelseitiges Klebeband



1A130323	0.05x10	■	8002929110053	4	-	-	-	-	32,05	128,20
----------	---------	---	---------------	---	---	---	---	---	-------	--------

### 3 CHIODI METALLICI A TESTA PIANA – FLAT-HEAD METAL NAILS – CLOUS MÉTALLIQUES À TÊTE PLATE – CLAVOS METÁLICOS DE CABEZA PLANA – METALLISCHE NÄGEL MIT FLACHKOPF



18 cm

1A120504	0.18	■	8002929106018	140	-	-	-	-	0,26	36,40
----------	------	---	---------------	-----	---	---	---	---	------	-------



## Salvaprato

Per proteggere il manto erboso dal continuo passaggio di persone e attrezzi da giardinaggio, TENAX offre eccellenti soluzioni in materiale sintetico proprio per il traffico veicolare leggero. Grazie alla loro speciale struttura, questi prodotti sono eccezionalmente durevoli ed efficaci, nonostante il peso e le dimensioni molto ridotte.

## Lawn reinforcement

To protect the turf from regular walking or gardening machines and cars repeatedly passing by, TENAX offers three excellent affordable synthetic grids for light vehicular traffic. Thanks to their special structure, these products are exceptionally durable and effective, despite very low weight and size.

## Grilles pour sols

Pour renforcer la pelouse et la protéger du passage assidu des piétons, des machines pour l'entretien du jardin et autos, en cas de circulation véhiculaire légère, TENAX propose à la portée de tous, trois grilles synthétiques qui garantissent un résultat optimal. Grâce à leur structure spéciale, ces produits sont très légers et peu encombrants, mais particulièrement résistants et efficaces.

## Protección del césped

Para proteger el césped natural y evitar que el paso frecuente de personas, maquinarias de jardín y coches lo estropeen, TENAX presenta una gama de enrejados sintéticos que garantizan excelentes resultados al alcance de todos. Gracias a su peculiar estructura, estos productos son muy resistentes y eficaces a pesar de su poco peso y sus escasas dimensiones.

## Rasengitter

Um den Rasen bei regelmäßigem Betreten oder vor Gartengeräten und Autos zu schützen bietet TENAX drei ausgezeichnete, kostengünstige Kunststoffelemente für leichten Fahrzeugverkehr an. Dank der speziellen Struktur sind diese Produkte besonders langlebig und effektiv, trotz sehr geringem Gewicht und Größe.



35x33 mm



### La rete salvaprato.

Griglia adatta come protezione di superfici già inerbite o per applicazioni di rinforzo anche temporaneo. Ideale per proteggere aree verdi soggette ad elevato calpestio o accessibilità.

### Lawn reinforcement mesh.

Grid suitable as a surface protection for existing grass (or for reinforcement applications including temporary ones). Ideal for protecting grassy areas subject to high traffic or accessibility.

### Le filet protège-gazon.

Grille particulièrement adaptée comme protection des superficies déjà désherbées ou pour des applications de renforcement même temporaires. Idéale pour protéger les espaces verts sujets à passage ou accessibilité intense.

### Protección para el césped natural.

Malla eficaz a las raíces garantizando una elevada protección del césped. Ideal para zonas de paso de vehículos y para evitar que los perros escurben en el terreno dañando el césped.

### Rasengitter.

Gitter besonders geeignet als Oberflächenschutz für vorhandene Rasenflächen (oder als Rasengitter, auch vorübergehend). Ideal zum Schutz von Rasenflächen mit hohem Verkehrsaufkommen oder starke Begehung.



MORE INFO

Cod.	m	-	EAN	N° x			€ m <sup>2</sup>	€ m	€	€
1A130210	1.00x5		8002929109040	4	9	-	-	-	21,00	84,00
61620308	2.00x30		8002929010810	-	-	8	3,79	7,58	-	227,40

## Accessori Accessories Accessoires Accesorios Zubehör

Cod.	m	-	EAN	N° x			€ m <sup>2</sup>	€ m	€	€
------	---	---	-----	------	--	--	------------------	-----	---	---

## CHIODI A U SPECIAL per TR – U STAPLES SPECIAL for TR – AGRAFES U SPECIALES pour TR – CLAVOS EN U ESPECIAL para TR – U-KLAMMERN SPEZIAL für TR



10 x 22 cm



10 pcs	1A150128	0.22		8002929115744	12	-	-	-	6,12	73,44
	1B100084	0.22		8002929012401	200	-	-	-	0,43	86,00

 **GP FLEX 1400**
**Prato rinforzato e verde protetto.**

Rete in plastica adatta per la realizzazione di parcheggi verdi, aree di passaggio o rimessaggio di auto, caravan o macchine da giardino.

**Reinforced lawns and green protection.**

Plastic mesh suitable for green car parks, transit areas or storage areas for cars, caravans or garden machines.

**Protection de la pelouse.**

Filet en plastique idéale pour la réalisation d'aires de parking verts et de passages ou de hangars d'autos, de caravanes ou de machines et outils d'entretien pour le jardin.

**Césped reforzado y raíces protegidas.**

Para estabilizar y reforzar zonas de paso o de aparcamiento para coches, caravanas o maquinaria agrícola. Malla muy resistente a la compresión tanto en aplicaciones permanentes como temporales.

**Verstärkung und Schutz von Rasen.**

Kunststoffgitter für Rasen-Parkplätze, Transitbereiche oder Parkplätze für Autos, Wohnwagen oder Gartenmaschinen.



MORE INFO

Cod.	m	-	EAN	N° x	x	x	€ m <sup>2</sup>	€ m	€	€	€
1A100492	1.00x10		8002929094896	-	-	16	8,95	8,95	-	-	89,50
1A090470	2.00x20		8002929091109	-	-	4	8,53	17,06	-	-	341,20

**Accessori****Accessories****Accessoires****Accesorios****Zubehör**

Cod.	m	-	EAN	N° x	x	x	€ m <sup>2</sup>	€ m	€	€	€
------	---	---	-----	------	---	---	------------------	-----	---	---	---

 **CHIODI A U GP FLEX – U STAPLES GP FLEX – AGRAFES U GP FLEX – CLAVOS EN U GP FLEX – U-KLAMMERN GP FLEX**

6 x 30 cm

1A050176	0.30		8002929072016	100	33	-	-	-	1,29	129,00
----------	------	--	---------------	-----	----	---	---	---	------	--------

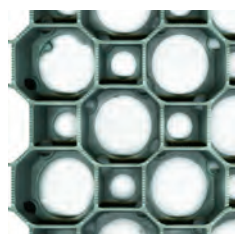
 **PRATOBLOCK**

56x56 mm

**Prato rinforzato.**

Grigliati quadrati agganciabili uno all'altro, per realizzare piccole pavimentazioni in giardino o vialletti di accesso. Atossici, drenanti, con alta resistenza alla compressione, vengono parzialmente nascosti dalla crescita dell'erba.

**Reinforced lawn.**

Square grids, interlocking, for making small paved areas in the garden or driveways. Non-toxic, draining, with high resistance to compression, partially hidden by the growth of grass.

**Gazon renforcé.**

Grilles modulaires carrées, accrochables les unes aux autres, pour la réalisation de petits dallages dans le jardin ou les allées d'accès. Non-toxiques, drainantes, résistantes à la compression, elles deviennent partiellement invisibles lors de la pousse de l'herbe.

**Césped reforzado.**

Baldosas que pueden ser enganchadas una con otra para formar pequeños pavimentos en los jardines o vías de acceso. Producidas con materiales atóxicos, realizan una función de drenaje, resisten a la compresión y se mimetizan con el césped natural cuando éste crece.

**Rasengitter.**

Quadratische Waben, untereinander fixierbar für kleine gepflasterte Flächen im Garten oder Einfahrten. Ungiftig, entwässernd, mit hoher Beständigkeit gegen Belastungen, teilweise durch das Wachstum von Gras verborgen.

Cod.	m	-	EAN	N° x	x	x	€ m <sup>2</sup>	€ m	€	€	€
1A090040	0.50x0.5		8002929087201	-	-	240 pcs	-	-	-	-	4,16



**COLTIVARE  
L'ORTO**

**CULTIVATE  
A VEGETABLE  
GARDEN**

**CULTIVER  
UN POTAGER**

**CULTIVAR  
UN HUERTO**

**DEN  
GARTEN  
BESTELLEN**

<i>Inverno</i>	<i>Winter</i>	<i>Hiver</i>	<i>Invierno</i>	<i>Winter</i>	
Veli protettivi	Protective fleeces	Toiles de protection	Velos protectores	Schutzvliese	86
<i>Primavera-Estate</i>	<i>Spring-Summer</i>	<i>Printemps-Été</i>	<i>Primavera-Verano</i>	<i>Frühling-Sommer</i>	
Tunnel e film	Tunnels and plastic films	Mini serre et films	Túnel y film	Tunnel und Folie	91
Antierbacce e pacciamatura	Weed control and mulching	Anti-mauvaises herbes et paillage	Antihierbas y acolchamiento	Unkrautbekämpfung und Mulchen	96
Reti per piante rampicanti e tutori	Climbing plants nets and supports	Filets et supports pour plantes grimpanes	Mallas para trepadoras y tutores	Netze für Kletterpflanzen und Stützen	102
Protezione colture	Crop protection	Protection culture	Protección para cultivos	Pflanzenschutz	108

**L'orto  
TENAX**

Sono sempre più le persone che decidono di dedicarsi alla coltivazione di un orto: più o meno grande, destinando una parte del giardino o su terrazze e balconi. Realizzare un orto richiede tempo e passione, ma anche, oltre alle colture, tutti i prodotti necessari alla sua realizzazione e alla protezione degli ortaggi.

Per proporre i prodotti più adatti, selezionare e testare i prodotti migliori Tenax ha realizzato e coltivato il proprio orto realizzando video tutorial per spiegare come utilizzarli al meglio.

**TENAX  
vegetable garden**

More and more people decide to grow a vegetable garden; it can be big or small, in a part of their garden or on terraces and balconies. A vegetable garden requires time and passion, but also, in addition to crops, all the products necessary to create it and to protect vegetables.

Tenax has grown its own vegetable garden in order to select and test the best products, thus offering only them to our customers. Moreover, we have created video tutorials which explain how to use those products properly.

**Le potager  
TENAX**

De plus en plus de personnes décident de se consacrer à la culture d'un potager : plus ou moins grand, allouant une partie du jardin ou sur terrasses et balcons. Créer un potager demande du temps et de la passion, mais aussi, outre les cultures, tous les produits nécessaires à sa création et à la protection des légumes.

Pour proposer les produits les mieux adaptés, sélectionner et tester les meilleurs produits, Tenax a réalisé et cultivé son propre potager en créant des tutoriels vidéo expliquant comment les utiliser au mieux.

**El huerto  
TENAX**

Cada vez son más las personas que deciden dedicarse al cultivo de un huerto, destinando para ello una parte del jardín o en terrazas y balcones. Para realizar un huerto se necesita tiempo y pasión, pero también, además de los cultivos, todos los productos necesarios para su realización y la protección de las hortalizas.

Para proponer los productos más adecuados, para seleccionar y probar los mejores productos, Tenax ha creado y cultivado el propio huerto realizando videotutoriales para explicar cómo utilizarlos a la perfección.

**Den TENAX  
GEMÜSEGARTEN**

Immer mehr Personen entscheiden sich für einen Gemüsegarten: ob groß oder klein, einen Teil des Gartens abtrennend oder auf Terrassen und Balkonen. Einen Gemüsegarten zu verwirklichen verlangt Zeit und Leidenschaft, aber auch, abgesehen von den Pflanzen, alle zur Verwirklichung und zum Schutz des Gemüses notwendigen Produkte.

Um die geeigneten Produkte anzubieten, die besten Produkte auszuwählen und zu testen, hat Tenax einen eigenen Gemüsegarten angelegt und bebaut um Video Tutorials zu drehen und zu erklären wie man sie am besten verwendet.





4



Inverno

Winter

Hiver

Invierno

Winter

### Veli protettivi

Una gamma completa di TNT tessuti non tessuti per la difesa dal freddo. In autunno ed in inverno, proteggono ortaggi, fiori e piante da frutta, evitando che i primi freddi o le gelate improvvise danneggino le colture. Utilizzati anche per proteggere e anticipare la crescita del prato in giardini e parchi.

### Protective fleeces

A complete range of non-woven fabrics to provide protection from the cold. They are used in autumn and winter to protect vegetables, flowers and fruit plants, avoiding the first cold and sudden frost damaging crops. Used also to protect grass growth and bring it forward in gardens and parks.

### Toiles de protection

Une gamme complète de tissus non-tissés, à utiliser en automne et en hiver pour protéger les légumes, les fleurs et les arbres fruitiers et éviter que les premiers froids ou les gelées soudaines ne puissent endommager les cultures. Également utilisé pour protéger et anticiper la croissance des pelouses dans les jardins et les parcs.

### Velos protectores

Una gama completa de tejidos-no-tejidos ideales para aislar la planta del frío. Perfectos también para el huerto y para evitar que el frío y las heladas dañen los cultivos. Utilizados también para proteger y adelantar el crecimiento del césped en los jardines y en los parques.

### Schutzvliese

Ein umfangreiches Angebot an Vliesstoffen um im Herbst und Winter Gemüse, Blumen und Obst zu schützen und Schäden an den Pflanzen durch plötzliche erste Kälte und Frost zu verhindern. Sie werden auch zum Schutz verwendet um das Wachstum des Rasens in Gärten und Parks zu beschleunigen.

## ORTOCLIMA EXTRA

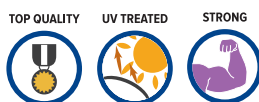
60 g/m<sup>2</sup>

### Contro il freddo più intenso.

Tessuto non tessuto ultra resistente, 60 g/m<sup>2</sup>, molto compatto. Ideale per proteggere piante delicate, siepi di aromatiche o di fiori dal freddo più intenso, anche nelle zone esposte al vento ed alle intemperie.

### Against the most intense cold.

A piece of ultra-resistant non-woven fleece, 60 g/m<sup>2</sup>. It is very compact and ideal for protecting delicate plants, herbal hedges and flowers from the very coldest weather, even in areas exposed to wind and violent weather.

### Contre le froid le plus intense.

Tissu non-tissé ultra résistant de 60 g/m<sup>2</sup>, très compact. Idéal pour protéger les plantes délicates, les haies, les plantes aromatiques ou les fleurs du froid glacial, même dans les zones exposées au vent et aux intempéries.

### Contra el frío más intenso.

Tejido-no-tejido tupido, ultra resistente, de 60 g/m<sup>2</sup> y muy compacto. Ideal para proteger las plantas delicadas y los setos del frío más intenso, incluso en las zonas expuestas al viento y a la intemperie.

### Gegen die intensive Kälte.

Ein extrem widerstandsfähiger Vliesstoff mit 60 g/m<sup>2</sup>. Es ist sehr kompakt und ideal zum Schutz von empfindlichen Pflanzen, Kräutern und Blumen vor sehr kaltem Wetter, auch in Bereichen, die Wind und heftigen Wetter ausgesetzt sind.

Cod.	m	-	EAN	N° x	x	x	€ m <sup>2</sup>	€ m	€	€
1A130285	2.00x5	<input type="checkbox"/>	8002929109651	12	24	-	-	-	5,80	69,60
1A130286	2.00x10	<input type="checkbox"/>	8002929109668	12	12	-	-	-	11,37	136,44



# ORTOCLIMA PLUS



30 g/m<sup>2</sup>



### Velo protettivo pesante.

Si utilizza durante i mesi freddi per proteggere le colture senza impedirne il normale sviluppo. Ideale sulle piante da frutto, per riparare le parti più delicate dal vento e dal freddo.

### Protective fleece for harsh climates.

It is used during the winter months to protect the most delicate plants from cold and wind, without affecting their regular growth. Ideal for fruit trees.

### Voile de protection pour climats rigides.

Il est utilisé pendant les mois d'hiver pour protéger les cultures sans empêcher le développement normal. Idéal sur les arbres fruitiers pour protéger les parties les plus délicates du vent et du froid.

### Velo protector para climas fríos.

Se utiliza durante los meses fríos para proteger cultivos sin impedir el crecimiento regular de la planta. Ideal en árboles frutales, para proteger las partes más delicadas del viento y del frío.

### Schutzvliese für Pflanzen in rauem Klima.

Es wird in den Wintermonaten benutzt um die empfindlichsten Pflanzen vor Kälte und Wind zu schützen, ohne ihr normales Wachstum zu beeinflussen. Ideal auch für Obstbäume.

Cod.	m	-	EAN	N° x	x	x	€ m <sup>2</sup>	€ m	€	€
73360031	1.60x10	<input type="checkbox"/>	8002929028570	12	35	-	-	-	5,28	63,36
73360041	2.40x5	<input type="checkbox"/>	8002929028587	12	35	-	-	-	3,96	47,52
<b>NEW</b> 1A180206	2.40x10	<input type="checkbox"/>	8002929125460	12	-	-	-	-	7,92	95,04
1A130287	1.60x500	<input type="checkbox"/>	8002929109675	-	-	14	0,20	-	-	162,79
1A130288	2.40x500	<input type="checkbox"/>	8002929109682	-	-	9	0,20	-	-	244,19
1A130289	4.00x250*	<input type="checkbox"/>	8002929109699	-	-	-	0,22	-	-	220,00



# ORTOCLIMA



17 g/m<sup>2</sup>

### Velo forzante e protettivo leggero.

Ideale per gli ultimi freddi e l'arrivo della primavera. Steso sulle colture le protegge dagli sbalzi climatici e favorisce la germinazione anticipandone il raccolto.

### Growth-protection cover.

Suitable for covering crops to protect them from changes in temperature, to promote germination and bring harvest time closer.

### Voile de forçage.

Idéal lors des derniers froids hivernaux et l'arrivée du printemps. Étendu sur les cultures, il les protège des brusques changements climatiques et favorise la germination en anticipant la récolte.

### Velo de crecimiento.

Ideal para las últimas semanas de frío y la llegada de la primavera. Se utiliza para proteger los cultivos de las variaciones de temperatura, favorecer el crecimiento y anticipar la cosecha.

### Wachstumsvliese.

Abdecken von Pflanzen um sie vor Temperaturschwankungen zu schützen, die Keimung zu fördern und früher zu ernten.

Cod.	m	-	EAN	N° x	x	x	€ m <sup>2</sup>	€ m	€	€
<b>NEW</b> 1A180202	1.60x5	<input type="checkbox"/>	8002929125422	12	55	-	-	-	1,44	17,28
73309701	1.60x10	<input type="checkbox"/>	8002929000699	12	55	-	-	-	2,88	34,56
1A110409	2.00x5	<input type="checkbox"/>	8002929099600	20	36	-	-	-	1,80	36,00
1A110410	2.00x10	<input type="checkbox"/>	8002929099617	20	24	-	-	-	3,60	72,00
73309771	2.40x10	<input type="checkbox"/>	8002929036582	12	35	-	-	-	4,32	51,84
73009201	1.60x250	<input type="checkbox"/>	8002929012975	-	-	20	0,14	-	-	57,43
1A040405	1.60x500	<input type="checkbox"/>	8002929069658	-	-	20	0,13	-	-	105,37
73009301	2.40x250	<input type="checkbox"/>	8002929012999	-	-	36	0,14	-	-	86,19
1A040406	2.40x500	<input type="checkbox"/>	8002929069665	-	-	20	0,13	-	-	158,10
73009351	4.00x250*	<input type="checkbox"/>	8002929013002	-	-	12	0,15	-	-	148,92

\* Tessuto piegato, ingombro rotolo 2 m. - Folded fabric, bulk roll 2 m. - Tissus plié, encombrement du rouleau 2 m. - Tejido doblado, tamaño del rollo 2 m. - Gefalteter Stoff, Ausmaß des Ballens 2 m.



# ZIPCLIMA EXTRA *Designed by Tenax*

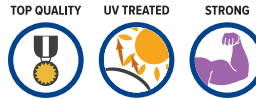

60 g/m<sup>2</sup>



**Con zip e lacci.**

Tessuto non tessuto bianco molto resistente, (60 g/m<sup>2</sup>) con comoda zip e lacci sul fondo indicato per la protezione di piante e piccoli alberi (agrumi). Riutilizzabile.

**Fabric with zip and straps.**

Highly resistant white non-woven fabric for protecting plants and small trees (citrus). For very cold climates, (60 g/m<sup>2</sup>). Reusable.

**Tissu avec fermeture éclair et cordons.**

Tissu non-tissé blanc très résistant (60 g/m<sup>2</sup>) pour la protection des plantes de petite et moyenne taille (agrumes) et des arbustes. Avec une fermeture éclair et des cordons sur le fond pour une installation plus rapide et une plante mieux protégée. Réutilisable.

**Tejido con cremallera.**

Saco de tejido-no-tejido blanco para la protección de plantas y pequeños árboles (por ejemplo, árboles cítricos). Ideal para climas muy fríos (60 g/m<sup>2</sup>) dispone de una cómoda cremallera para facilitar su instalación y proteger mejor la planta. Reutilizable.

**Vlies mit Reißverschluss und Verschlusskordel.**

Sehr widerstandsfähiger weißer Vliesstoffe zum Schutz von Pflanzen und kleinen Bäumen (Citrus). Für sehr kaltes Klima, (60 g/m<sup>2</sup>). Wiederverwendbar.

	Cod.	m	-	EAN	N° x	x	x	€ m <sup>2</sup>	€ m	€	€
3 pcs	1A150348	*0.80x1	<input type="checkbox"/>	8002929117441	24	24	-	-	-	6,09	146,16
1 pc	1A150347	**2.00x2.40	<input type="checkbox"/>	8002929117434	12	30	-	-	-	9,90	118,80

\* Semi-circonferenza – Semi-circumference – Demi-circonférence – Semicirconferencia – Halber Umfang / 0.5 m ø  
 \*\* Semi-circonferenza – Semi-circumference – Demi-circonférence – Semicirconferencia – Halber Umfang / 1.27 m ø



# TUBOCLIMA PLUS



30 g/m<sup>2</sup>

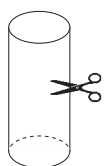

**Tubolare protettivo antigelo.**

Tessuto da 30 g/m<sup>2</sup>, di forma tubolare per facilitare l'applicazione su piante e arbusti di dimensioni contenute: si infila dall'alto sulla pianta e si fissa alle estremità, per proteggere da condizioni climatiche avverse.

**Frost-proof protective tubular fleece.**

A 30 g/m<sup>2</sup> piece of tube-shaped fleece which can be easily fitted on small plants and shrubs: it is slipped on top of the plant, and is fixed at the end of the plant to protect it from adverse weather conditions.

**Tubulaire de protection antigel.**

Tissu de 30 g/m<sup>2</sup>, de forme tubulaire pur faciliter l'application sur les plantes et les arbustes de petites dimensions: il s'enfile par le haut et se fixe aux extrémités pour protéger la plante des conditions météorologiques défavorables.

**Velo protector tubular.**

Tejido-no-tejido de 30 g/m<sup>2</sup> con forma tubular que permite colocarlo fácilmente sobre árboles, plantas y arbustos. Se coloca como un tubo y se fija en los extremos para protegerlo de las condiciones climáticas adversas.

**Frostsicheres schlauchförmiges Schutzvlies.**

Schlauchförmiges 30 g/m<sup>2</sup> Vlies das ganz einfach bei kleinen Pflanzen oder Sträucher angebracht werden kann: es wird von oben über die Pflanze gezogen, oben und unten geschlossen und schon ist sie vor ungünstigen Wetterbedingungen geschützt.

	Cod.	m	-	EAN	N° x	x	x	€ m <sup>2</sup>	€ m	€	€
	73361021	*1.20x5	<input type="checkbox"/>	8002929028594	12	35	-	-	-	5,62	67,44

\* Semi-circonferenza – Semi-circumference – Demi-circonférence – Semicirconferencia – Halber Umfang / 0.70 m ø

## SACCOCLIMA PLUS

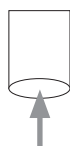
30 g/m<sup>2</sup>**Cappuccio antigelo.**

Tessuto da 30 g/m<sup>2</sup> pre-tagliato, chiuso su tre lati a forma di sacco, si infila sulle piante per proteggerle da gelo e vento. Per una protezione più efficace, si suggerisce di custodire le piante in vaso in luogo riparato.

**Frost-proof cap.**

A pre-cut piece of 30 g/m<sup>2</sup> fleece, sealed at both sides to form a bag-like shape. It is slipped on top of the plant to protect it from the cold and wind. To guarantee maximum protection, we suggest you keep the plant pot in a sheltered area.

**Capuchon antigel.**

Tissu prédécoupé de 30g/m<sup>2</sup>, fermé sur trois cotés, en forme de sac. Il s'enfile sur les plantes pour les protéger du gel et du vent. Pour une protection plus efficace, nous vous conseillons de conserver les plantes en pot dans un endroit abrité.

**Saco protector para frío intenso.**

Tejido-no-tejido tupido de 30 g/m<sup>2</sup> precortado con cierre de saco que se coloca sobre las plantas como una capucha para protegerlas de la nieve y del viento. Para una protección más eficaz, se recomienda proteger las plantas de maceta en un lugar cubierto.

**Frostsichere Schutzhülle.**

Ein vorgefertigtes 30 g/m<sup>2</sup> Vlies das an beiden Seiten geschlossen ist um eine taschenförmige Form zu erhalten. Es wird über die Pflanze gezogen um sie vor Kälte und Wind zu schützen. Für den optimalen Schutz wird empfohlen den Pflanzentopf an einen geschützten Ort zu stellen.

	Cod.	m	-	EAN	N° x	x	x	€ m <sup>2</sup>	€ m	€	€
3 pcs	1A110419	*1.00x1.60	<input type="checkbox"/>	8002929099709	12	32	-	-	-	3,30	39,60
3 pcs	1A130290	**1.80x2	<input type="checkbox"/>	8002929109705	12	20	-	-	-	7,50	90,00

\* Semi-circonferenza – Semi-circumference – Demi-circonférence – Semicircunferencia – Halber Umfang / 0.60 m ø

\*\* Semi-circonferenza – Semi-circumference – Demi-circonférence – Semicircunferencia – Halber Umfang / 1.15 m ø

4

## SACCOCLIMA

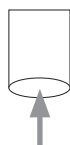
17 g/m<sup>2</sup>**Cappuccio protettivo per freddi moderati.**

Tessuto da 17 g/m<sup>2</sup> pre-tagliato, chiuso su tre lati a forma di sacco, si infila sulle piante in vaso per proteggerle da freddo e vento. Non ostacola il passaggio di luce, aria ed acqua e consente uno sviluppo regolare.

**Protective cap for moderate cold climates.**

Saccoclima is a pre-cut piece of 17 g/m<sup>2</sup> fleece, which can be slipped directly onto potted plants. It will protect them from cold, wind and insects, without obstructing the passage of light, air and water.

**Capuchon de protection pour froids modérés.**

Tissu prédécoupé de 17 g/m<sup>2</sup>, fermé sur trois cotés, en forme de sac. Il s'enfile sur les plantes en pot pour les protéger du froid et du vent. Il n'empêche pas le passage de la lumière, de l'air et de l'eau et permet une croissance régulière.

**Saco protector.**

Tejido-no-tejido de 17 g/m<sup>2</sup>, precortado con cierre de saco que se coloca sobre las plantas como una capucha para protegerlas del frío y del viento. No obstaculiza el paso de la luz, el aire y el agua y permite un crecimiento regular de la planta.

**Schutzhülle für normal kalte Klimazonen.**

Saccoclima ist ein vorgefertigtes 17 g/m<sup>2</sup> Schutzvlies für Pflanzen, das direkt über die Topfpflanzen gezogen wird. Es schützt sie vor Kälte, Wind und Insekten ohne den Durchlass von Licht, Luft und Wasser zu behindern.

	Cod.	m	-	EAN	N° x	x	x	€ m <sup>2</sup>	€ m	€	€
4 pcs	73308361	*1.00x1.60	<input type="checkbox"/>	8002929059635	12	50	-	-	-	3,40	40,80
3 pcs	73308371	**1.60x2	<input type="checkbox"/>	8002929059642	12	35	-	-	-	3,60	43,20

\* Semi-circonferenza – Semi-circumference – Demi-circonférence – Semicircunferencia – Halber Umfang / 0.60 m ø

\*\* Semi-circonferenza – Semi-circumference – Demi-circonférence – Semicircunferencia – Halber Umfang / 1.00 m ø



Primavera-Estate

Spring-Summer

Printemps-Été

Primavera-Verano

Frühling-Sommer

### Tunnel e film

La primavera richiede un'attenzione particolare verso le piante: i primi germogli e i primi frutti vanno protetti dalle repentine escursioni climatiche, dal vento e dalla brina. La gamma di film plastici TENAX garantisce non solo la protezione delle colture, ma ne sostiene e rafforza lo sviluppo, creando un microclima che favorisce la crescita e anticipa il raccolto.

### Tunnels and plastic films

In spring plants require special attention: the first shoots and the first fruits need protection from sudden weather changes, wind and frost. The TENAX range of plastic films and fabrics ensures not only crop protection, but supports and strengthens development, creating a microclimate that promotes growth and brings the harvest forward.

### Mini serre et films

Le printemps demande une attention particulière pour les plantes : les premiers bourgeons et les premiers fruits doivent être protégés des intempéries soudaines, du vent et du gel. La gamme de films plastiques et de textiles TENAX assure non seulement la protection des cultures, mais il soutient et renforce leur développement. Il favorise la création d'un climat favorable à la croissance et permet d'anticiper la récolte.

### Túnel y film

Durante la primavera las plantas necesitan una atención especial: los primeros brotes y los primeros frutos tienen que estar protegidos de las variaciones de temperatura, del viento y del frío. La gama de films y tejidos TENAX garantiza no sólo la protección de cultivos, sino que sostiene y refuerza su desarrollo, creando un microclima para favorecer el crecimiento y adelantar la cosecha.

### Tunnel und Folie

Im Frühjahr benötigen Pflanzen besondere Aufmerksamkeit: die ersten Triebe und die ersten Früchte erfordern einen Schutz vor plötzlichen Wetteränderungen, Wind und Frost. Das TENAX Angebot an Kunststoff-Folien und Geweben bietet nicht nur Pflanzenschutz, sondern unterstützt und stärkt ihre Entwicklung, indem sie ein Mikroklima schaffen, das das Wachstum fördert und ein frühere Ernte ermöglicht.

4

TOP QUALITY UV TREATED EXTENSIBLE STRONG



## EARLY TUNNEL



120 µ

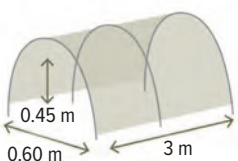

### Mini serra per primizie.

Già pronto all'uso, un tunnel in polietilene trasparente ed estensibile con incorporati gli archetti metallici di sostegno. Ideale per primizie, protegge gli ortaggi da variazioni di temperatura e crea un microclima ideale. Ripiegabile e facile da riporre, è riutilizzabile per più stagioni.

### Mini-greenhouse for first fruits.

Immediately ready for use, this transparent polyethylene tunnel has metal support arches to fix it down. It is ideal for first fruits and protects vegetables from changes in temperature, creating an ideal microclimate. Foldable and easy to move, it can be reused over many seasons.

### Mini serre pour les primeurs.

Prêt à l'emploi, un tunnel en polyéthylène transparent et extensible avec des arcs métalliques de soutien intégrés. Idéal pour les fruits et légumes, protège des changements de température et crée un microclimat propice. Pliable et facile à ranger, il est réutilisable pendant plusieurs saisons.

### Mini invernadero para primicias.

Listo para su uso: túnel extensible fabricado en polietileno transparente que incorpora 6 arcos metálicos de sujeción. Ideal para proteger los cultivos de las variaciones atmosféricas y crear un microclima idóneo. Fácil de extender y de recoger, puede guardarse y reutilizarse.

### Mini-Gewächshaus für erste Früchte.

Für den sofortigen Einsatz ist die Polyethylenfolie an den Metallstützbögen bereits befestigt. Ideal für erste Früchte und schützt Gemüse vor Temperaturschwankungen indem es ein optimal Mikroklima schafft. Zusammenfaltbar und leicht aufzubewahren, kann es viele Jahre wiederverwendet werden.

Cod.	m	-	EAN	N° x	x	x	€ m <sup>2</sup>	€ m	€	€
1A110423	0.60x0.45x3	☑	8002929099747	6	30	-	-	-	25,99	155,94

## COAT FILM

UV TREATED



50 μ

**Impermeabile e protettivo.**

Film trasparente di spessore aumentato a 50 micron, totalmente impermeabile, si stende su piccoli tunnel per proteggere le colture dalle improvvise escursioni termiche, facilitando ed accelerandone la crescita.

**Growth boosting film.**

Clear, permeable and protective plastic film, 50 microns thick. All-purpose film for creating a tunnel to protect plants from cold and accelerate their growth.

**Film de forçage.**

Film transparent de 50 microns d'épaisseur, totalement imperméable. Il s'étend sur de petits tunnels pour protéger les cultures des brusques changements de températures. Il facilite et accélère la croissance.

**Film de crecimiento.**

Film transparente de 50 micras de grosor totalmente impermeable. Se coloca en pequeños túneles para proteger los cultivos de las inclemencias del tiempo, facilitando y acelerando su crecimiento.

**Schutzfolie zur Wachstumsförderung.**

Transparente, durchlässige und schützende Kunststoff-Folie, 50 Mikron dick. Allzweckfolie für das Errichten von Schutztunnels um die Pflanzen vor Kälte zu schützen und ihr Wachstum zu beschleunigen.

Cod.	m	-	EAN	N° x	x	x	€ m <sup>2</sup>	€ m	€	€
72151810	2.00x5	<input checked="" type="checkbox"/>	8002929027962	10	100	-	-	-	5,67	56,70
72151830	2.00x10	<input checked="" type="checkbox"/>	8002929027979	10	40	-	-	-	8,80	88,00
73070010	2.00x100	<input checked="" type="checkbox"/>	8002929054920	-	-	-	0,27	0,54	-	53,75

4

## DOT FILM

UV TREATED MICRO-PERFORATED



40 μ

**Film microforato.**

Film trasparente e permeabile ad aria ed acqua. Steso su tunnel o direttamente sugli ortaggi, favorisce lo sviluppo delle piante, le protegge dalle aggressioni naturali (grandine, insetti ed uccelli) e ne anticipa il raccolto. Ideale per primizie.

**Micro-perforated film.**

A transparent plastic film permeable to air and water. It can be installed on greenhouse arches or laid directly onto vegetable patches; it speeds up growth and protects plants from natural dangers such as cold, hail, insects and birds.

**Micro-perforé et respirant.**

Film transparent perméable à l'air et à l'eau. Posé sur le tunnel ou directement sur les légumes. Il favorise la croissance des plantes, les protège des agressions naturelles (grêle, insectes, oiseaux...) et permet d'anticiper la récolte. Idéal pour une maturation précoce des fruits et légumes.

**Microperforado y transpirable.**

Film transparente microperforado y permeable al aire y al agua. Usado en pequeños túneles e invernaderos o aplicado directamente sobre los cultivos, los protege de las agresiones naturales (granizo, insectos y pájaros) y favorece el adelanto de su cosecha. Ideal para primeros brotes.

**Mikroperforierte Schutzfolie.**

Eine transparente, luft- und wasserdurchlässige Kunststoff-Folie. Sie kann auf Gewächshaus-Bögen oder direkt auf Gemüsebeeten verlegt werden; sie beschleunigt das Wachstum und schützt Pflanzen vor natürlichen Gefahren wie Kälte, Hagel, Insekten und Vögel.

Cod.	m	-	EAN	N° x	x	x	€ m <sup>2</sup>	€ m	€	€
72211810	2.00x5	<input checked="" type="checkbox"/>	8002929036216	10	100	-	-	-	6,38	63,80

# SUN FILM



70 μ



**Anticipa il raccolto.**

Film impermeabile giallo, con spessore aumentato a 70 micron, attenua le variazioni di temperatura e trasmette l'energia solare alle colture, accelerandone la crescita ed aumentando i rendimenti. Molto resistente, è efficace per tutti i tipi di ortaggi.

**Speeds up harvesting.**

Our waterproof yellow film is now available with an increased thickness (70 microns). It softens the effects of changes in temperature as well as allowing solar energy to access the crops, accelerating their growth and increasing their yield. It is highly resistant and suitable for use on all types of vegetables.

**Anticipe la récolte.**

Nouveau film jaune imperméable, maintenant d'une épaisseur de 70 microns, réduit les variations de température et transmet l'énergie solaire aux cultures, accélère la croissance et augmente les rendements. Très résistant, il est efficace pour tous les types de légumes.

**Adelanta la cosecha.**

Film impermeable amarillo, con todavía mayor grosor (70 micras) que atenúa las variaciones de temperatura y transmite el calor a los cultivos, favoreciendo su crecimiento y facilitando la cosecha. Muy resistente, ideal para todo tipo de hortalizas.

**Beschleunigt die Ernte.**

Diese wasserdichte gelbe Folie ist jetzt mit einer größeren Dicke (70 Mikron) verfügbar. Sie mildert die Auswirkungen von Temperaturveränderungen und ermöglicht, dass die Pflanzen mit Sonne versorgt werden, ihr Wachstum beschleunigt und die Ernte verbessert wird. Sie ist sehr widerstandsfähig und für den Einsatz bei allen Arten von Gemüse geeignet.

Cod.	m	-	EAN	N° x	x	x	€ m <sup>2</sup>	€ m	€	€
1A130291	2.00x5		8002929109712	10	48	-	-	-	5,83	58,30
1A130030	3.00x10		8002929099723	10	27	-	-	-	15,30	153,00

4

**SUN FILM**



**DOT FILM**



## MR. TOMATO



50 μ

**Accelera la crescita dei pomodori.**

Film tubolare giallo microforato. Si infila sulle singole piante di pomodoro per favorire ed accelerare la crescita. Il colore giallo attira i raggi solari e li concentra sui piccoli frutti, che maturano precocemente e meglio. Il film è perforato, per garantire la necessaria aerazione. Ripara dalle piogge forti e dalle grandinate. Evita l'attacco degli uccelli.

**Designed for tomatoes.**

Yellow, tube-shaped film which can be slipped over tomatoes plants in order to foster and accelerate growth. Its yellow hue attracts the sun rays and concentrates them on smaller fruits which then ripen more quickly and more healthily. The film has been perforated to allow enough air to enter. Shields from heavy rain and hail. Shields from bird attacks.

**Spécifiquement pour les tomates.**

Film tubulaire micro perforé de couleur jaune. Il s'enfile sur les plants de tomates individuels pour favoriser et accélérer la croissance. La couleur jaune attire les rayons du soleil et se concentre sur les petits fruits qui mûrissent plus tôt. Le film est perforé afin d'assurer l'aération nécessaire. Protège de la pluie et de la grêle. Evite l'attaque des oiseaux.

**Especial para tomates.**

Film tubular amarillo microperforado que se coloca por encima de las tomates para favorecer y acelerar su crecimiento. El color amarillo atrae los rayos solares y los concentra sobre los frutos que maduran más rápido y mejor. El film está perforado para garantizar la aireación necesaria. Protege de las fuertes lluvias y del granizo. Evita que los pájaros se coman los frutos.

**Speziell für Tomaten.**

Gelbe, schlauchförmige Folie, die über die Tomatenpflanzen gestülpt werden kann um das Wachstum zu beschleunigen. Ihr gelber Farbton zieht die Sonnenstrahlen an und konzentriert sie auf die kleinen Früchte, die dann schneller und gesünder reifen. Für eine gute Luftzirkulation ist die Folie gelocht. Schutz vor starkem Regen und Hagel. Schützt vor Vogellattacken.

Cod.	m	-	EAN	N° x			€ m <sup>2</sup>	€ m	€	€
1A130292	*0.60x10	■	8002929109729	10	-	-	-	-	6,16	61,60

\* Semi-circonferenza – Semi-circumference – Demi-circonférence – Semicircunferencia – Halber Umfang



## HOW TO MAKE A TUNNEL





## Accessori

## Accessories

## Accessoires

## Accesorios

## Zubehör

Cod. m - EAN N° x  x  x  € m<sup>2</sup> € m €  €  € 

## ARCHETTI PER TUNNEL – TUNNEL HOOPS SET – ARCHES POUR TUNNEL – ARQUITOS – PFLANZTUNNEL RAHMEN SET

6 tubi da 85 cm + 3 raccordi da 15 cm – 6 tubes of 85 cm + 3 links of 15 cm – 6 arches de 85 cm + 3 raccords de 15 cm – Envasado de 6 arquitos de 85 cm + 3 accesorios de unión de 15 cm – Packung mit 6x85 cm Bögen + 3x15 cm Verbindungen

99530100	0.85+0.15		8002929038296	6	40	-	-	-	8,06	48,36
----------	-----------	---	---------------	---	----	---	---	---	------	-------

## PICCHETTI PER TUNNEL – TUNNEL PEGS – PIQUETS POUR TUNNEL – ESTACAS TUNEL – PLANZTUNNEL HERINGE

Confezione da 8 pezzi – Pack of 8 pieces – Sachet de 8 pièces – Envasado en bolsas de 8 unidades – Packung mit 8 Stk.

99540100	0.21		8002929038302	12	77	-	-	-	2,39	28,68
----------	------	---	---------------	----	----	---	---	---	------	-------

## FERMATELO PER TUNNEL – TUNNEL CLIPS – CLIPS POUR TUNNEL – CLIPS DE SUJECION – PFLANZTUNNEL CLIPS

Per tubi da ø 9 mm a 18 mm, confezione da 12 pezzi – For tubes from about ø 9 mm to 18 mm, pack of 12 pieces – Pour tubes au diamètre allant de 9 mm à 18 mm environ, sachet de 12 pièces – Envasado en bolsas de 12 unidades, para arquitos de ø 9 - 18 mm – Für Rohre von ø 9 mm bis 18 mm, Packung mit 12 Stk.

99161100	-		8002929038319	12	90	-	-	-	1,52	18,24
----------	---	---	---------------	----	----	---	---	---	------	-------

4



MORE INFO

VIDEO  
TUTORIAL



Primavera-Estate

Spring-Summer

Printemps-Été

Primavera-Verano

Frühling-Sommer

### Antierbacce e pacciamatura

TENAX propone una gamma di film, teli e tessuti-non-tessuti che, stesi attorno alle colture, mantengono l'umidità del terreno ma tolgono la luce, privando così i semi delle erbacce della possibilità di svilupparsi.

### Weed control and mulching

TENAX offers a range of films, covers and nonwoven fabrics which, laid around the crops, maintain the humidity of the ground but stop light filtering, thereby depriving the weed seeds of the chance to develop.

### Anti-mauvaises herbes et paillage

TENAX propose une gamme de films, de toiles et de tissus non-tissés, qui, posés autour des cultures, maintiennent l'humidité du sol, mais les privent de lumière, empêchant ainsi aux graines des mauvaises herbes la possibilité de se développer.

### Antihierbas y acolchamiento

TENAX presenta una gama de films, telas y tejidos-no-tejidos que, colocados alrededor de los cultivos, mantienen la humedad del terreno y no dejan pasar la luz para que las semillas de las malas hierbas no crezcan.

### Unkrautbekämpfung und Mulchen

TENAX bietet eine Reihe an Folien, Abdeckungen und Vliesstoffen, die bei den Pflanzen ausgelegt werden und dem Boden Feuchtigkeit spenden, aber das Licht stoppen, wodurch sich die Unkrautsamen nicht entwickeln können.

4

**COVER PRO**



#### Telo professionale.

Molto fitto ma non impermeabile, garantisce qualità e pulizia delle colture riducendo la manutenzione. La struttura particolarmente robusta lo rende ideale su piccole pendenze o scarpate, dove concorre ad evitare il dilavamento della terra. Perfetto anche per l'utilizzo in aiuole, siepi e viali, grazie al colore verde che si integra perfettamente con l'ambiente. Cover Pro, verde e nero, hanno la quadrettatura per facilitare il posizionamento delle piante.

#### Professional cover.

Very fine but not waterproof, it ensures quality and cleanliness, reducing maintenance. The particularly robust structure makes it ideal on slight slopes or embankments, where it helps to prevent leaching of the earth. It is also perfect for use in flowerbeds, hedges and paths, thanks to its green colour which fits in perfectly with the environment. Cover Pro in green and black are squared to aid in positioning the plants.

#### Toile professionnelle.

Très dense mais perméable à l'eau, elle assure la qualité et la propreté des cultures réduisant l'entretien. Cette structure est particulièrement résistante, ce qui la rend idéale pour les petites pentes ou les talus, elle contribue à empêcher le ruissèlement de la terre. Convient également sur les parterres de fleurs, les haies et les allées, grâce à sa couleur verte qui s'intègre parfaitement avec l'environnement. Avec quadrillage afin de faciliter le positionnement des plantes.

#### Tela profesional.

Muy tupido pero no impermeable conservando así la limpieza y calidad de los cultivos y, por tanto, reduciendo el mantenimiento. Especialmente robusta, pudiéndose emplear incluso en pequeñas pendientes o cuevas para evitar pequeños desprendimientos del suelo. Ideal para el uso en parterres y caminos, puesto que el color verde se integra perfectamente con el ambiente. Se presenta con una retícula para facilitar el posicionamiento de las plantas.

#### Professionelles Unkrautgewebe.

Sehr dicht, aber wasserdurchlässig. Somit wird die Qualität und Sauberkeit der Pflanzen gewährleistet und die Pflege vereinfacht. Die besonders robuste Struktur macht sie ideal für leichte Hängen oder Böschungen, wo es hilft die Auslaugung der Erde zu verhindern. Es ist auch perfekt für die Verwendung in Blumenbeeten, Hecken und Wegen, dank der grünen Farbe, passt es sich perfekt der Umgebung. Für eine Positionierung der Pflanzen sind sie mit Markierungslinien versehen.

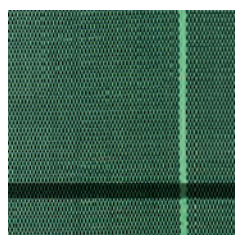
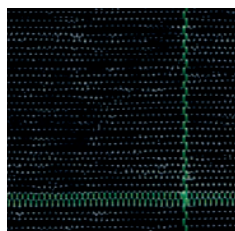
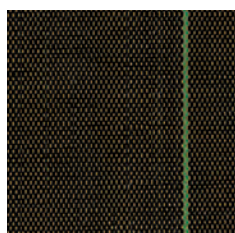
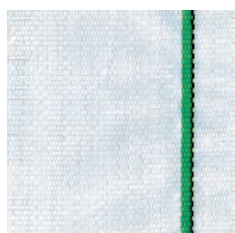

VIDEO TUTORIAL

 **COVER PRO**
**GREEN**  
105 g/m<sup>2</sup>**BLACK**  
105 g/m<sup>2</sup>**BROWN**  
105 g/m<sup>2</sup>**WHITE**  
105 g/m<sup>2</sup>

Cod.	m		EAN	N° x	x	x	€ m <sup>2</sup>	€ m	€	€
1A070448	1.00x10		8002929081957	6	24	-	-	-	18,03	108,18
1A110405	1.25x10		8002929099563	6	32	-	-	-	21,66	129,96
1A050337	2.00x5		8002929069115	6	12	-	-	-	18,03	108,18
73350059	1.60x5		8002929036186	10	35	-	-	-	15,15	151,50
1A160213	1.60x5		8002929120458	10	35	-	-	-	14,59	145,90
1A070112	0.52x100		8002929079275	-	-	50	0,69	0,36	-	35,88
1A050087	0.52x100		8002929071330	-	-	50	0,63	0,33	-	32,76
73050606	1.05x100		8002929056283	-	-	25	0,69	0,72	-	72,45
73050609	1.05x100		8002929056047	-	-	25	0,63	0,66	-	66,15
1A070618	1.05x100		8002929083333	-	-	25	0,81	0,85	-	85,05
73050616	1.65x100		8002929056290	-	-	25	0,69	1,14	-	113,85
73050619	1.65x100		8002929056054	-	-	25	0,63	1,04	-	103,95
1A070619	1.65x100		8002929083340	-	-	25	0,81	1,34	-	133,65
73050626	2.10x100		8002929056306	-	-	25	0,69	1,45	-	144,90
73050629	2.10x100		8002929056061	-	-	25	0,63	1,32	-	132,30
1A070620	2.10x100		8002929083357	-	-	25	0,81	1,70	-	170,10
73050211	2.10x100		8002929030528	-	-	25	0,81	1,70	-	170,10
73050636	3.30x100*		8002929056313	-	-	16	0,69	2,28	-	227,70
73050639	3.30x100*		8002929056078	-	-	16	0,63	2,08	-	207,90
1A060400	4.20x100*		8002929076847	-	-	16	0,69	2,90	-	289,80
73050649	4.20x100*		8002929056030	-	-	16	0,63	2,65	-	264,60
1A060401	5.25x100*		8002929076854	-	-	16	0,69	3,62	-	362,25
73050659	5.25x100*		8002929056085	-	-	16	0,63	3,31	-	330,75

\* Telo piegato a metà - \* Fabrics folded in two - \* Toile pliée à moitié - \* Telones doblados por la mitad - \* Bahnen zur Hälfte gefaltet

VERDE: con riquadri di 13x18 cm (verticali verdi e orizzontali neri). NERO: con riquadri verdi di 15 cm. MARRONE: con righe verticali verdi ogni 15 cm.

BIANCO: con righe verticali verdi ogni 15 cm.

GREEN: with 13x18 cm squares (vertical green and horizontal black). BLACK: With 15 cm green squares. BROWN: With vertical green lines every 15 cm.

WHITE: with vertical green lines every 15 cm.

VERT: avec un quadrillage de 13x18 cm (vertical vert et horizontal noir). NOIR: Avec un contour vert de 15 cm. MARRON: Avec des lignes verticales vertes tous les 15 cm.

BLANC: avec des lignes verticales vertes tous les 15 cm.

VERDE: con cuadros de 13x18 cm (líneas verticales verdes y horizontales negras). NEGRO: Con recuadros verdes de 15 cm. MARRÓN: Con rayas verdes verticales cada 15 cm.

BLANCO: con rayas verdes verticales cada 15 cm.

GRÜN: mit 13x18 cm großen Rechtecken (vertikal grün und horizontal schwarz). SCHWARZ: Mit 15 cm grünen Quadraten. BRAUN: Mit vertikalen grünen Linien alle 15 cm.

WEISS: mit vertikalen grünen Linien alle 15 cm.

Avvertenza! - Si consiglia di evitare l'utilizzo di composti agrochimici (fitofarmaci con zolfo) sia in modalità acuta che cronica, poiché a contatto con il materiale possono provocare un potenziale deterioramento.

Warning! - It is advisable to avoid using agrochemicals (plant health products with sulphur) both in acute and chronic manner because, if they are in contact with the material, it can deteriorate.

Avertissement! - Il est conseillé d'éviter l'utilisation de composés agrochimiques (produits phytosanitaires contenant du soufre) à la fois en mode aigu et chronique, car au contact de la matière, ceux-ci peuvent causer une détérioration potentielle.

Advertencia! - Se recomienda evitar el uso de compuestos agroquímicos (fitofármacos con azufre) tanto en la modalidad aguda como en la crónica, ya que pueden provocar un posible deterioro si se encuentran en contacto con el material.

Hinweis! - Es wird empfohlen, sowohl in der akuten als auch chronischen Behandlung, keine agrochemischen Verbindungen (Pflanzenschutzmittel mit Schwefel) zu verwenden, weil sie bei Kontakt mit dem Material zu dessen Beschädigung führen können.

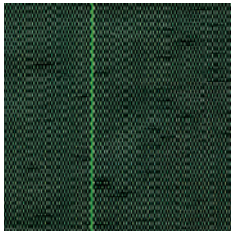
 **COVER HG**
88 g/m<sup>2</sup>**Telo multiuso  
e pacciamante light.**

Telo hobbistico principalmente utilizzato come telo antierbacce per orto e giardino. Realizzato in polipropilene a trama fitta garantisce una buona resistenza agli UV e alla lacerazione.

**Multipurpose  
and light mulching  
cover.**

Hobby cover mainly used for weed control in the vegetable and flower garden. Made from tightly woven polypropylene, it provides good resistance to UV and tearing.

**Toile multi-usage  
et de paillage.**













Toile principalement utilisée comme toile anti mauvaises herbes pour potager et jardin, réalisée en polypropylène à trame compacte, elle garantit une bonne résistance aux UV et à la déchirure.

**Tela multiuso  
y antihierbas ligera.**

Tejido en polietileno fabricado a partir de una trama tupida de buena resistencia a los rayos UV y al desgarro.

**Mehrzweck-  
und leichtes  
Unkrautgewebe.**

Abdeckung hauptsächlich zur Unkrautbekämpfung im Gemüse- und Blumengarten. Hergestellt aus dicht gewebtem Polypropylen, bietet es eine gute UV-Beständigkeit und ist reißfest.

Cod.	m	-	EAN	N° x 	 x 	 x 	€ m <sup>2</sup>	€ m	€  	€  
1A150483	1.00x100		8002929118424	-	-	25	0,59	0,59	-	59,00
1A150484	1.57x100		8002929118431	-	-	25	0,59	0,93	-	92,63
1A150485	2.07x100		8002929118448	-	-	25	0,59	1,22	-	122,13
1A170135	3.30x100*		8002929122636	-	-	16	0,59	1,95	-	194,70

Telo piegato – Fabrics folded – Toile pliée – Telones doblados – Bahnen gefaltet



Avvertenza! - Si consiglia di evitare l'utilizzo di composti agrochimici (fitofarmaci con zolfo) sia in modalità acuta che cronica, poiché a contatto con il materiale possono provocare un potenziale deterioramento.

Warning! - It is advisable to avoid using agrochemicals (plant health products with sulphur) both in acute and chronic manner because, if they are in contact with the material, it can deteriorate.

Avertissement! - Il est conseillé d'éviter l'utilisation de composés agrochimiques (produits phytosanitaires contenant du soufre) à la fois en mode aigu et chronique, car au contact de la matière, ceux-ci peuvent causer une détérioration potentielle.

Advertencia! - Se recomienda evitar el uso de compuestos agroquímicos (fitofármacos con azufre) tanto en la modalidad aguda como en la crónica, ya que pueden provocar un posible deterioro si se encuentran en contacto con el material.

Hinweis! - Es wird empfohlen, sowohl in der akuten als auch chronischen Behandlung, keine agrochemischen Verbindungen (Pflanzenschutzmittel mit Schwefel) zu verwenden, weil sie bei Kontakt mit dem Material zu dessen Beschädigung führen können.

# FULL COVER

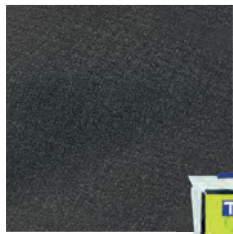
100 g/m<sup>2</sup>

**Tessuto antierbacce.** Tessuto-non-tessuto permeabile, consente il passaggio di aria, acqua e fertilizzanti ma impedisce la crescita delle erbacce che toglierebbero nutrimento alle piante coltivate. Ideale in giardino, per aiuole o come sottofondo per vialetti; **necessita di copertura con ghiaia o corteccia per una lunga durata nel tempo.**

**Fabric for mulching.** Non-woven fabric permeable to water, air and fertilisers. This product will prevent weeds from growing and eliminate the need to use herbicides. Ideal in the garden for flowerbeds, it can also be used as a soil stabilizer for creating new pathways. **Always remember to cover the product with gravel or bark, to avoid sun damage.**

**Tissu anti mauvaises herbes.** Tissu non-tissé permettant le passage de l'air, de l'eau et des engrais. Il empêche la croissance des mauvaises herbes qui supprimerait les éléments nutritifs pour les plantes cultivées. Idéal dans le jardin pour des parterres de fleurs ou comme base pour les allées, **il faut ensuite le couvrir avec une couche d'écorces ou de gravier afin d'assurer une longue durée.**

**Tejido antihierbas.** Tejido-no-tejido permeable que permite el paso del aire, el agua y los fertilizantes, pero impide el crecimiento de las malas hierbas que quitan los nutrientes a las plantas cultivadas. Ideal para el jardín, para las jardineras y para estabilizar el suelo en los caminos. **Necesita que se le aplique una capa de grava o corteza para protegerlo de los rayos del sol.**

**Unkrautvlies.** Vliesstoff durchlässig für Wasser, Luft und Düngemittel. Dieses Produkt verhindert das Wachstum von Unkraut und macht die Verwendung von Herbiziden unnötig. Ideal im Garten für Blumenbeete und als Bodenstabilisator für den Bau neuer Wege. **Das Vlies immer mit Kies oder Rinde abdecken um eine Schädigung durch die Sonnen zu vermeiden.**

Cod.	m	-	EAN	N° x	x	x	€ m <sup>2</sup>	€ m	€	€
73304059	0.90x5	■	8002929032232	10	35	-	-	-	8,14	81,40
73304159	1.80x3	■	8002929036155	10	35	-	-	-	9,26	92,60
73004209	0.90x50	■	8002929012906	-	-	30	1,40	1,26	-	63,00
73004309	1.80x50	■	8002929012913	-	-	30	1,40	2,52	-	126,00

## Accessori Accessories Accessoires Accesorios Zubehör

Cod.	m	-	EAN	N° x	x	x	€ m <sup>2</sup>	€ m	€	€
------	---	---	-----	------	---	---	------------------	-----	---	---

## CHIODI METALLICI PROFESSIONALI – PROFESSIONAL METAL STAPLES – AGRAFES MÉTALLIQUES PROFESSIONNELLES – CLAVOS METÁLICOS PROFESIONALES – PROFI METALLKLAMMERN

STRONG



Confezione da 20 pezzi – Pack of 20 pieces – Sachet de 20 pièces – Envasado en bolsas de 20 unidades – Packung mit 20 Stk.

1A160218	-	■	8002929120496	20	33	-	-	-	6,57	131,40
----------	---	---	---------------	----	----	---	---	---	------	--------

20 x 25 cm

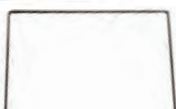

# BLACK & WHITE COVER *Designed by Tenax*



40 μ



**5 vantaggi,  
1 solo prodotto.**  
Film in polietilene  
da 40 micron  
accoppiato: **bianco**  
nella parte superiore  
e **nero** nella parte  
inferiore.

1. La parte nera a contatto con la terra impedisce la crescita di erbacce.
2. Favorisce la maturazione delle piante.
3. Il terreno resta fresco e risparmi acqua.
4. Non brucia le piante giovani.
5. Il colore bianco disorienta gli afidi. Molte colture traggono beneficio da questo tipo di film; in particolare le insalate estive, i cavolfiori e i cavoli broccoli, oltre ai piccoli frutti, come le fragole.

**5 advantages,  
a single product.**  
40 micron double-  
face polyethylene  
film: **white** on  
top and **black**  
underneath.

1. The black part is in contact with the ground and prevents weed growth.
2. It enhances plant maturation.
3. It keeps the soil fresh, saving water.
4. It does not burn young plants.
5. It keeps aphids and small insects away from crop. Crops which commonly benefit from this type of film are summer salads, cauliflower and broccoli, as well as small fruits like strawberries.

**5 Avantages,  
1 seul produit.**  
Film en polyéthylène  
de 40 microns:  
**blanc** sur la partie  
supérieure et **noir** sur  
la partie inférieure.

1. La partie noire en contact avec la terre empêche la pousse de mauvaises herbes.
2. Favorise la maturation des plantes.
3. Maintient le terrain frais et réduit la consommation d'eau.
4. Ne brûle pas les jeunes pousses.
5. La couleur blanche désoriente les pucerons. Beaucoup de récoltes profitent de ce type de film, en particulier les salades d'été, les choux-fleurs et choux brocolis, en plus des petits fruits comme les fraises.

**5 ventajas,  
un único producto.**  
Film de polietileno  
de 40 micras bicapa:  
**blanco** en la parte  
superior y **negro** en  
la parte inferior.

1. La parte negra en contacto con la tierra impide el crecimiento de las malas hierbas.
2. Favorece el desarrollo de las plantas.
3. Mantiene la temperatura suave del terreno, lo que permite ahorrar agua.
4. No quema las plantas jóvenes.
5. El color blanco confunde a los pulgones. Muchos cultivos sacan beneficio de este tipo de film, especialmente lechuga, coliflor y brócoli, además de pequeños frutos como las fresas.

**5 Vorteile, ein  
einziges Produkt.**  
40 Mikron dicke,  
doppelseitige  
Polyethylenfolie:  
oben **weiß** und unten  
**schwarz**.

1. Der schwarze Teil steht in Kontakt mit dem Boden und verhindert das Wachstum von Unkraut.
2. Verbessert das Pflanzenwachstum.
3. Hält den Boden feucht und spart Wasser.
4. Verbrennt keine Jungpflanzen.
5. Hält Blattläuse und kleine Insekten von den Früchten fern. Besonders geeignet für Sommersalate, Blumenkohl und Brokkoli, sowie kleine Früchte wie Erdbeeren.

4

Cod.	m	-	EAN	N° x	x	x	€ m <sup>2</sup>	€ m	€	€
1A150331	1.40x10		8002929117342	10	100	-	-	-	7,60	76,00
1A150362	1.40x100		8002929117557	-	-	-	0,55	0,77	-	76,50



VIDEO  
TUTORIAL

## BLACK COVER



40 μ

**Film impermeabile per fragole.**

Di colore nero, mantiene il calore e l'umidità del terreno ma priva le infestanti di aria, acqua e luce, impedendone la crescita. Pratico ed economico, è ideale per fragole e ortaggi, poiché crea le condizioni ideali per lo sviluppo ed evita che i frutti si sporchino a contatto con il terreno.

**Waterproof film for strawberries.**

This PE black film will keep the soil warm and humid and will deprive weeds of air, light and water. Practical and convenient, it provides the best conditions for growth of strawberries and vegetables, avoiding contact with the soil, thus keeping them clean.

**Film imperméable pour les fraises.**

De couleur noire, il conserve la chaleur et l'humidité du sol, mais le prive des mauvaises herbes, de l'air, de l'eau et de la lumière, ce qui empêche la croissance. Pratique et économique, il est idéal pour les fraises et les légumes car il crée les conditions idéales pour le développement et empêche les fruits en contact avec le sol de salir.

**Film impermeable para fresas.**

De color negro, mantiene el calor y la humedad del terreno pero priva del aire, el agua y la luz a las malas hierbas para que éstas no crezcan. Práctico y económico, crea las mejores condiciones para el cultivo de fresas y hortalizas en general, evitando el contacto con la tierra y, por tanto, manteniéndolas limpias.

**Wasserdichte Folie für Erdbeeren.**

Diese schwarze PE-Folie hält die Erde warm und feucht und schirmt Unkraut von Luft, Licht und Wasser ab. Praktisch und angenehm bietet sie die besten Bedingungen für das Wachstum von Erdbeeren und Gemüse und vermeidet den Kontakt mit dem Boden, so dass sie sauber bleiben.

Cod.	m	-	EAN	N° x	x	x	€ m <sup>2</sup>	€ m	€	€
1A130301	1.40x10	■	8002929109811	10	100	-	-	-	6,08	60,80
1A130168	2.00x10	■	8002929108739	10	40	-	-	-	7,44	74,40
73070069	1.50x100	■	8002929059680	-	-	-	0,43	0,64	-	64,26



## DOT COVER

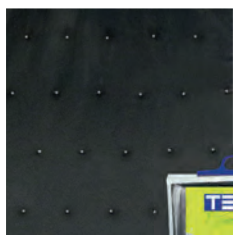
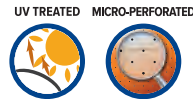

40 μ

**Film microforato per ortaggi.**

Film in PE nero con micro-fori che consentono una parziale aerazione e irrigazione del terreno, impedendo in ogni caso lo sviluppo delle erbe infestanti. Ideale per frutti a terra ed ortaggi.

**Micro-perforated film for vegetables.**

A permeable black polyethylene sheet, DOT COVER is micro-perforated to allow limited aeration and irrigation of the soil. It prevents weeds from growing and is ideal both for fruits and vegetables.

**Film micro-perforé pour potager.**

Film en PE noir avec des micro-trous qui permettent une aération partielle et l'irrigation du sol. Il empêche le développement de mauvaises herbes. Idéal pour les fruits et légumes au sol, il augmente les rendements.

**Film microperforado para el huerto.**

Film microperforado fabricado en PE de color negro que permite la ventilación y el riego del terreno e impide el desarrollo de las malas hierbas. Ideal para frutales (por ejemplo fresas) y hortalizas.

**Mikro-perforierte Folie für Gemüse.**

Die durchlässige schwarze Polyethylenfolie DOT COVER ist mikro-perforiert um begrenzte Belüftung und Bewässerung des Bodens zu ermöglichen. Sie verhindert das Wachstum von Unkraut und ist ideal sowohl für Obst als auch für Gemüse.

Cod.	m	-	EAN	N° x	x	x	€ m <sup>2</sup>	€ m	€	€
72202119	1.50x5	■	8002929036193	10	100	-	-	-	4,87	48,70
72202139	1.50x10	■	8002929036209	10	88	-	-	-	7,52	75,20
<b>NEW</b> 1A180300	1.50x100	■	8002929126160	-	-	-	0,49	0,74	-	73,50





Primavera-Estate

Spring-Summer

Printemps-Été

Primavera-Verano

Frühling-Sommer

### Reti per piante rampicanti e tutori

Per facilitare lo sviluppo di ortaggi e piante, due reti leggere e resistenti rappresentano una soluzione efficace ed economica. Una gamma diversificata di tutori per giardino o per orto, in colori e materiali diversi, completa l'offerta dei sostegni.

### Climbing plants nets and supports

A simple and nice price solution to support and favour the growth of vegetable plants and flowers are FLORA and HORTONOVA nets. TENAX also offers a range of stakes, available in plastic or coated metal, to aid plant growth.

### Filets et supports pour plantes grimpanes

Pour faciliter la croissance des légumes et des plantes, deux filets très légers mais résistants sont la solution idéale, efficace et économique. La gamme TENAX est complétée par une ligne de tuteurs pour le jardin ou le potager, simples et décoratifs, proposés en plastique ou en métal plastifié.

### Mallas para trepadoras y tutores

Para facilitar el desarrollo de hortalizas y plantas, dos mallas ligeras pero resistentes representan una solución eficaz y económica. Por otra parte, TENAX también ofrece una gama de tutores simples y decorativos, con colores y materiales diferentes, que completan la gama de productos para el huerto.

### Netze für Kletterpflanzen und Stützen

Eine einfache und preisgünstige Lösung zur Unterstützung und Wachstumsförderung von Gemüsepflanzen und Blumen sind FLORA und HORTONOVA Netze. TENAX bietet auch eine Reihe von Stützen aus Kunststoff oder beschichtetem Metall an um das Pflanzenwachstum zu unterstützen.



150x170 mm\*

#### Rete per rampicanti.

Ampia maglia sottile che, tesa nell'orto fra più pali di legno, facilita la crescita ordinata e rigogliosa di pomodori, fagiolini e ogni altro rampicante.

Un sistema pratico, veloce ed economico che sostiene lo sviluppo verticale degli ortaggi e ne facilita la raccolta. Di colore verde, in confezioni self-service per piccoli appezzamenti.

#### Vegetable support net.

When stretched between wooden posts in the garden, this wide, thin mesh helps tomatoes, green beans, and other climbing plants to grow in a luxuriant and orderly manner. It has been designed to provide vertical support for vegetables, offering a practical, fast and cost effective growing system and facilitating their harvesting. It is available in green and in pre-packs for small orchards.

#### Filet pour plantes grimpanes.

Une maille large et mince. Légère et résistante qui, installée verticalement dans le potager, facilite la croissance ordonnée et florissante des tomates, des haricots verts et de tout autre légume grimpanant. Un système pratique, rapide et économique qui soutient le développement vertical des légumes et facilite leur récolte. De couleur verte, dans des emballages en libre-service pour les petites parcelles.

#### Malla para trepadoras.

Malla fina de luz amplia que, instalada entre los soportes, facilita el crecimiento ordenado de hortalizas como tomates o judías. Un sistema práctico, rápido y económico que ayuda al crecimiento de las hortalizas y facilita su cosecha. De color verde, disponible también en prácticos embalajes para el autoservicio.

#### Ranknetz.

Flora ist besonders als senkrechte Kletterhilfe für Kletterpflanzen wie zum Beispiel Tomaten, Erbsen, Bohnen, Gurken usw. geeignet. Zwischen Holzpflocken im Garten gespannt bietet dieses widerstandsfähige und doch leichte Netz ein kostengünstiges Wachstumssystem. Es ist in Grün und in Kleinverpackungen für kleine Obstgärten verfügbar.

\* La dimensione della maglia può variare fino ad un massimo di  $\pm 10\%$  – Mesh dimensions can vary by  $\pm 10\%$  either way – La dimension de la maille peut varier jusqu'à un maximum de  $\pm 10\%$  – La dimensiones de la malla pueden variar hasta un máximo de  $\pm 10\%$  – Die Gittergrößen können um  $\pm 10\%$  variieren





Cod.	m	-	EAN	N° x	x	x	€ m <sup>2</sup>	€ m	€	€
57006200	1.50x10		8002929031679	24	48	-	-	-	4,39	105,36
57006300	1.70x10		8002929031686	24	48	-	-	-	4,50	108,00
57006400	2.00x5		8002929031709	24	48	-	-	-	3,08	73,92
57006500	2.00x10		8002929031693	24	48	-	-	-	4,74	113,76
1A150437	2.00x10		8002929031693	12	35	-	-	-	5,20	62,40
57006511	2.00x20		8002929031716	18	36	-	-	-	9,12	164,16
1A090438	1.50x10		8002929090812	24	48	-	-	-	3,50	84,00
1A090439	1.70x10		8002929090829	24	48	-	-	-	3,60	86,40
1A090440	2.00x5		8002929090836	24	48	-	-	-	2,46	59,04
1A090441	2.00x10		8002929090843	24	48	-	-	-	3,79	90,96
1A090442	2.00x20		8002929090850	18	36	-	-	-	7,29	131,22





150x170 mm\*

**Rete per ortaggi  
e fiori.**

Prodotta in polipropilene di prima qualità realizzata con esclusivo processo di estrusione e bi-stiratura che ne assicura eccellenti doti di resistenza e durata nel tempo, è idonea per tutte le diverse tecniche colturali. Ha sostituito reti metalliche e tralici in ferro oppure materiali deperibili come canne di bambù e legno. L'applicazione di Tenax Hortonova come supporto verticale assicura ottimo arieggiamento, ideale esposizione al sole e migliore sfruttamento degli spazi, sia per le operazioni di coltura che di raccolta.

**Mesh for vegetables  
and flowers.**

Produced from top quality polypropylene and made with the exclusive dual stretching extrusion process that ensures optimum strength and duration. It has replaced metal meshes, iron trellises and perishable materials such as bamboo canes or wood. Using Tenax Hortonova for vertical support ensures excellent ventilation, ideal exposure to the sun and better use of space, for both cultivation and harvesting.

**Filet pour plantes  
grimpanes.**

Produit en polypropylène de première qualité avec un procédé exclusif d'extrusion et de bi-passage qui garantit d'excellentes caractéristiques en termes de résistance et de durabilité. Il est adapté à différentes techniques de culture. Il a remplacé les grillages métalliques et les treillis en fer ou encore d'autres matériaux périssables tels que les cannes de bambou et le bois. L'application de Tenax Hortonova comme support vertical assure une excellente aération, une exposition parfaite au soleil et une meilleure utilisation des espaces, à la fois pour les opérations de culture que de cueillette.

**Malla para  
trepadoras.**

Producida en polipropileno de alta calidad con un exclusivo proceso de bi-orientación que le aporta resistencia y durabilidad en el tiempo, esta malla ha sustituido tanto mallas metálicas y tutores de hierro como materiales deteriorables (por ejemplo, las cañas de bambú). La aplicación de Tenax Hortonova como soporte vertical asegura una excelente aireación. Perfecta para estar expuesta al sol y para mejorar el uso del espacio, tanto en las operaciones de cultivo como de cosecha.

**Ranknetz für Gemüse  
und Blumen.**

Hergestellt aus hochwertigem Polypropylen und mit dem speziellen Streckvorgang in beide Richtungen wird optimale Festigkeit und lange Lebensdauer gewährleistet. Es hat die traditionell verwendeten Materialien wie Gitter aus Metall, Eisengitter und verrottbaren Materialien wie Bambusstäben oder Holz ersetzt. Mit der vertikalen Verwendung von Tenax Hortonova wird eine hervorragende Belüftung, ideale Sonneneinwirkung und eine bessere Flächennutzung für den Anbau und die Ernte gewährleistet.

4



Cod.	m	-	EAN	N° x	x	x	€ m <sup>2</sup>	€ m	€	€
7 FG <b>NEW</b>	58010607	1.02x100	□	8002929008749	12	16	-	-	14,21	170,52
8 FG <b>NEW</b>	58010608	1.19x100	□	8002929008756	12	16	-	-	15,64	187,68
10 FG <b>NEW</b>	1A080280	1.53x50	□	8002929085832	6	42	-	-	14,64	87,84
10 FG <b>NEW</b>	58010610	1.53x100	□	8002929008770	9	16	-	-	17,98	161,82
11 FG <b>NEW</b>	1A080281	1.70x50	□	8002929085849	6	42	-	-	15,81	94,86
11 FG <b>NEW</b>	58010611	1.70x100	□	8002929008787	6	16	-	-	19,54	117,24
13 FG <b>NEW</b>	1A080282	2.04x50	□	8002929085856	6	42	-	-	18,15	108,90
13 FG <b>NEW</b>	58010613	2.04x100	□	8002929008794	6	16	-	-	20,73	124,38
7 FG	58012007	1.02x500	□	8002929008831	-	-	30	-	-	51,20
7 FG	58012507	1.02x1000	□	8002929008930	-	-	20	-	-	93,00
8 FG	58012008	1.19x500	□	8002929008848	-	-	30	-	-	56,90
8 FG	58012508	1.19x1000	□	8002929008947	-	-	20	-	-	103,60
9 FG	58012009	1.36x500	□	8002929008855	-	-	30	-	-	63,90
9 FG	58012509	1.36x1000	□	8002929008954	-	-	20	-	-	116,10
10 FG	58012010	1.53x500	□	8002929008862	-	-	30	-	-	68,40
10 FG	58012510	1.53x1000	□	8002929008961	-	-	20	-	-	124,20
11 FG	58012011	1.70x500	□	8002929008879	-	-	30	-	-	73,50
11 FG	58012511	1.70x1000	□	8002929008978	-	-	20	-	-	133,60
13 FG	58012013	2.04x500	□	8002929008886	-	-	30	-	-	83,90
13 FG	58012513	2.04x1000	□	8002929008985	-	-	20	-	-	152,50

\* La dimensione della maglia può variare fino ad un massimo di ±10% - Mesh dimensions can vary by ±10% either way - La dimension de la maille peut varier jusqu'à un maximum de ±10% - La dimensiones de la malla pueden variar hasta un máximo de ±10% - Die Gittergrößen können um ±10% variieren

## SPIRAL UP PLUS

**Tutore a spirale  
in ferro verniciato.**

Tutore a spirale specifico per pomodori e ortaggi rampicanti. Non arrugginisce ed è molto resistente ad ogni condizione atmosferica.

**Painted spiral iron support.**

Spiral support specifically for tomatoes and climbing vegetables. Durable, does not rust and can withstand any weather conditions.

**Spirale en fer verni.**

Tuteur en forme de spirale spécifique pour les tomates et les légumes grimpanes. Très résistant, ne rouille pas et résiste à toutes les conditions atmosphériques.

**Tutor de acero barnizado en espiral.**

Tutor en espiral específico para tomates y hortalizas trepadoras. Muy resistente, no se corroe y resiste a cualquier condición atmosférica.

**Lackierte, spiralförmige Eisenstäbe.**

Spiralförmige Stäbe für Tomaten und Klettergemüse. Langlebig, rostet nicht und hält allen Wetterbedingungen stand.

Cod.	m	-	EAN	N° x	x	x	€ m <sup>2</sup>	€ m	€  /	€  /
1A150241	1.50-ø 6.5 mm		8002929116642	15	-	-	-	-	1,12	16,80
1A150242	1.80-ø 6.5 mm		8002929116659	15	-	-	-	-	1,29	19,35
1A150243	2.10-ø 6.5 mm		8002929116666	15	-	-	-	-	1,52	22,80

Pezzo etichettato singolarmente – Piece individually labelled – Pièce étiquetée individuellement – Pieza etiquetada individualmente – Jedes Stück einzeln belabell

## STEEL UP

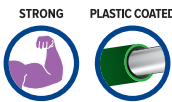
**Robusto e grippante.**

Tutore in acciaio plastificato, con un'estremità appuntita per facilitarne l'inserimento nel terreno. La superficie rugosa favorisce l'ancoraggio di piante e fiori rampicanti.

**Metal gripping stake.**

Plastic coated steel stake which is pointed at one end for easy insertion into the ground. Its rough surface helps plants climb.

**Robuste avec surface agrippante.**

En acier plastifié, pointu d'un côté pour faciliter l'implantation dans le sol. Il dispose d'une surface rugueuse pour faciliter l'accrochage des plantes et des fleurs grimpanes.

**Resistente y antideslizante.**

Tutor de acero plastificado puntiagudo en un extremo para facilitar su inserción en el terreno. Con superficie rugosa, favorece el anclaje de las plantas y flores trepadoras.

**Stützstangen aus Metall.**

Kunststoffbeschichtete Stange aus Stahl, die an einem Ende spitz ist für das einfachere Einbringen im Boden. Ihre raue Oberfläche erleichtert das Hochklettern der Pflanzen.

Cod.	m	-	EAN	N° x	x	x	€ m <sup>2</sup>	€ m	€  /	€  /
73387560	0.90-ø 8 mm		5010453928009	12	-	-	-	-	1,00	12,00
73387561	1.20-ø 11 mm		5010453929006	12	-	-	-	-	1,47	17,64
73387562	1.50-ø 11 mm		5010453930002	12	-	-	-	-	1,94	23,28
73387563	1.80-ø 16 mm		5010453931009	12	-	-	-	-	2,45	29,40
1A150328	2.10-ø 16 mm		8002929117311	12	-	-	-	-	2,85	34,20
1A150393	2.40-ø 16 mm		8002929117854	12	-	-	-	-	3,17	38,04

Pezzo etichettato singolarmente – Piece individually labelled – Pièce étiquetée individuellement – Pieza etiquetada individualmente – Jedes Stück einzeln belabell

## SPIRAL UP PLUS



## STEEL UP



 **STAND UP**
**Tutore tradizionale  
per ortaggi.**

Tutore in plastica riciclata, cavo all'interno e rifinito a cortecchia d'albero, per favorire l'ancoraggio della piantina. Ideale nell'orto.

**Conventional stake  
for vegetables.**

Plastic stake made from recycled polymer, hollow inside, finished in tree bark which helps plants to climb. Ideal for orchards.

**Tuteur traditionnel  
pour les légumes.**

Tuteur en plastique recyclé, creux à l'intérieur et en forme d'écorce d'arbre, pour faciliter l'ancrage de la plante. Idéal dans le jardin.

**Tutor tradicional  
para hortalizas.**

Tutor de plástico reciclado, hueco en su interior y con acabado que imita la corteza de árbol, para facilitar el anclaje de las plantas durante su crecimiento. Ideal para el huerto.

**Herkömmliche  
Stützstangen für  
Gemüse.**

Kunststoffstützen aus recycelten Polymeren, innen hohl mit einer rauhe Oberflächenstruktur zum leichteren Klettern der Pflanzen. Ideal für den Obstbau.



Cod.	m	-	EAN	N° x	x	x	€ m <sup>2</sup>	€ m	€	€
73387023	1.50-Ø 23 mm	■	8002929039507	20	-	-	-	-	0,77	15,40
73387043	1.80-Ø 27 mm	■	8002929039521	20	-	-	-	-	1,03	20,60
73387053	2.10-Ø 27 mm	■	8002929039538	20	-	-	-	-	1,19	23,80
73387063	2.30-Ø 27 mm	■	8002929039545	20	-	-	-	-	1,31	26,20

Pezzo etichettato singolarmente – Piece individually labelled – Pièce étiquetée individuellement – Pieza etiquetada individualmente – Jedes Stück einzeln belabelt

**BAMBOO TUTOR****Supporto  
per piante.**

Tutore in bamboo naturale.

**Plant support.**

Made of natural bamboo.

**Support  
pour plantes.**

Fabriquée à partir de bambou naturel.

**Soporte  
para plantas.**

Tutor de bambú natural.

**Stützstab.**

Hergestellt aus natürlichem Bambus.



	Cod.	m	-	EAN	N° x	x	x	€ m <sup>2</sup>	€ m	€	€
7 pcs	1A150481	0.90	■	8002929118417	15	-	-	-	-	1,58	23,70
4 pcs	1A150479	1.20	■	8002929118400	20	-	-	-	-	1,58	31,60
3 pcs	1A150477	1.50	■	8002929118394	20	-	-	-	-	1,67	33,40
3 pcs	1A150475	1.80	■	8002929118387	20	-	-	-	-	2,19	43,80
2 pcs	1A150473	2.10	■	8002929118370	25	-	-	-	-	2,02	50,50
1 pc	1A150471	2.40	■	8002929118363	20	-	-	-	-	1,09	21,80

**BAMBOO TUTOR****BAMBOO UP**

TOP QUALITY

**BAMBOO UP****Tutore ad imitazione del naturale.**

Nuovo tutore sintetico di aspetto simile al bambù. Cavo all'interno, è realizzato con materiale di prima qualità che conferisce rigidità e aumenta resistenza e durata nel tempo. Ideale nell'orto ed in giardino per il sostegno di piante e fiori.

**Natural looking.**

A new synthetic support which looks very similar to bamboo. Hollow on the inside, it has been made with first-class materials which offer rigidity and increased resistance and durability. It is ideal in vegetable gardens in plant and flower support.

**Tuteur à imitation naturelle.**

Nouveau tuteur synthétique à l'aspect naturel du bambou. Creux à l'intérieur et fabriqué avec des matériaux de première qualité qui lui confèrent une rigidité et une meilleure résistance dans le temps. Idéal dans le jardin et dans le potager pour supporter les plantes et les fleurs.

**Tutor parecido al bambú.**

Tutor de plástico muy parecido al bambú. Hueco en su interior, está fabricado con materiales de primera calidad que le aportan rigidez, aumentando la resistencia y la durabilidad. Ideal en el huerto y en el jardín para la sujeción de plantas y flores.

**Natürlich aussehend.**

Eine neue synthetischer Stütze, die Bambus sehr ähnlich sieht. Innen hohl, hergestellt aus hochwertigen Materialien, die Steifigkeit und erhöhte Beständigkeit und Haltbarkeit garantieren. Ideal in Gemüse- und Hausgärten zum Stützen von Pflanzen und Blumen.

	Cod.	m	-	EAN	N° x	x	x	€ m <sup>2</sup>	€ m	€	€
6 pcs	1A130294	0.90-ø 18 mm		8002929109743	12	-	-	-	-	5,36	64,32
6 pcs	1A130295	1.20-ø 18 mm		8002929109750	12	-	-	-	-	5,82	69,84
4 pcs	1A130296	1.50-ø 25 mm		8002929109767	12	-	-	-	-	7,15	85,80
4 pcs	1A130297	1.80-ø 25 mm		8002929109774	12	-	-	-	-	7,86	94,32
4 pcs	1A130298	2.10-ø 25 mm		8002929109781	12	-	-	-	-	8,82	105,84
1 pc	1A150392	2.40-ø 25 mm		8002929117847	20	-	-	-	-	2,04	40,80

**COCOPOLE****Bastone muschiato.**

In fibra di cocco con anima in plastica per il sostegno di piante ornamentali in casa, come il Potos, come sostegno decorativo in giardino e per la coltivazione di piante.

**Coir pole.**

Made of coir fibres wrapped on a plastic stick, it can be used to support ornamental plants inside houses, for example golden Pothos, or you can use it as decorative support in gardens or to grow plants.

**Bâton musqué.**

En fibre de coco avec une âme en plastique pour soutenir les plantes ornementales à la maison, telles que le Potos, comme support décoratif dans le jardin et pour la culture de plantes.

**Tutor recubierto de fibras.**

De fibra de coco con estructura de plástico para la sujeción de plantas ornamentales para la casa, como el Poto, como sujeción decorativa en el jardín o para el cultivo de plantas.

**Kokos-Stab.**

Aus Kokosfasern mit Kunststoffkern zum Stützen von Zimmerpflanzen, wie z.B. Potos, als dekorative Stütze und zur Pflanzenzucht.

	Cod.	m	-	EAN	N° x	x	x	€ m <sup>2</sup>	€ m	€	€
	1A150467	0.80-ø 32 mm		8002929118349	1	-	-	-	-	-	3,55
	1A150469	1.20-ø 50 mm		8002929118356	1	-	-	-	-	-	6,12
	1A160256	1.50-ø 50 mm		8002929120786	1	-	-	-	-	-	7,57



Primavera-Estate

Spring-Summer

Printemps-Été

Primavera-Verano

Frühling-Sommer

### Protezione colture

Installate su strutture di supporto o stese direttamente sulle colture, le reti antigrandine, anti-uccelli, anti-insetto offrono un rimedio pratico e conveniente per la salvaguardia del raccolto, senza pregiudicarne in alcun modo lo sviluppo.

### Crop protection

Installed on support structures or laid directly on plants, the hail-proof, bird-proof meshes, anti-aphid meshes offer a practical and convenient solution to safeguard the harvest.

### Protection culture

Installés sur des structures de support ou étendus directement sur les cultures, les filets anti-grêle, anti-oiseaux, anti-pucerons offrent une solution pratique et commode en termes de protection des récoltes sans en affecter leur développement.

### Protección para cultivos

Colocadas sobre túneles y estructuras de soporte o directamente sobre las plantas, las mallas anti-pájaros, antigranizo, antiplagas aseguran una protección práctica y económica para los cultivos sin interferir en su normal desarrollo.

### Pflanzenschutz

Installiert auf Tragstrukturen oder direkt auf den Pflanzen, bieten die hagel- und vogelfeste, Antisekt- werk Netze eine praktische und einfache Lösung um die Ernte zu schützen.



VIDEO TUTORIAL

4

## DEFENDER PLUS

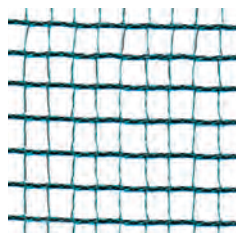
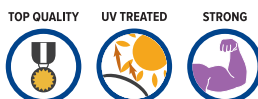

7x8 mm

**Antigrandine tessuta a doppio filo.**  
Garantisce una resistenza allo strappo superiore ed una maggiore durata nel tempo.

**Double thread woven anti-hail netting.**  
Extra strength and longer durability.

**Anti-grêle tissé en double fil.**  
Pour garantir une meilleure résistance à la traction et une plus grande longévité.

**Malla antigranizo tejida a doble hilo.**  
Ofrece una resistencia superior a la rotura y una mayor durabilidad en el tiempo.

**Doppelfaser Hagelschutznetz.**  
Für besondere Festigkeit und eine längere Lebensdauer.

Cod.	m	-	EAN	N° x	x	x	€ m²	€ m	€	€
73021909	2.00x50		8002929050991	-	-	50	0,54	1,08	-	54,00
73021209	2.00x100		8002929013170	-	-	24	0,50	1,00	-	100,00
73023206	4.00x50		8002929051332	-	-	20	0,54	2,16	-	108,00
73021409	4.00x100		8002929013187	-	-	12	0,50	2,00	-	200,00
73021609	6.00x100		8002929013194	-	-	15	0,50	3,00	-	300,00
73023506	8.00x50		8002929051608	-	-	12	0,55	4,40	-	220,00
73021809	8.00x100		8002929030917	-	-	9	0,51	4,08	-	408,00

Le reti in altezza 2 m e 4 m vengono piegate ed i rotoli risultano alti 1 m. Le reti in altezza 6 m e 8 m vengono piegate più volte ed i rotoli risultano alti 2 m.  
2 m and 4 m high products are folded in 1 m rolls, 6 m and 8 m high products are folded in 2 m rolls.  
Les hauteurs 2 m e 4 m sont pliées en rouleaux de 1 m. Les hauteurs 6 m e 8 m sont pliées en rouleaux de 2 m.  
Las alturas de 2 m y 4 m están dobladas en rollos de 1 m. Las alturas de 6 m y 8 m están dobladas en rollos de 2 m.  
Die Abmessungen 2 m und 4 m sind auf 1 m Breite gefaltet. Die Abmessungen 6 m und 8 m sind auf 2 m Breite gefaltet.



7x8 mm

**Antigrandine  
tessuta monofilo.**

Resistente e flessibile, utilizzata anche per ombreggiare lievemente e per proteggere dai volatili.

**One thread woven  
anti-hail netting.**

Light and flexible but resistant, it is ideal as hail protection netting, but it is also used for light shading and bird protection purposes.

**Anti-grêle tissé  
en mono-fil.**







Résistant et flexible, il est également utilisé pour ombrager légèrement ou pour protéger des oiseaux.

**Malla antigranizo  
tejida en  
monofilamento.**

Resistente y flexible. Se utiliza también para sombreo o para proteger de las aves.

**Einzelfaser  
Hagelschutznetz.**

Leicht und flexibel, aber beständig. Ideal als Hagelschutznetz, aber auch für leichte Beschattungen oder als Vogelschutz zu verwenden.

Cod.	m	-	EAN	N° x 	 x 	 x 	€ m <sup>2</sup>	€ m	€ 	€ 
73321706	2.00x5	■	8002929050687	6	50	-	-	-	8,57	51,42
1A100151	2.00x10	■	8002929092366	12	15	-	-	-	13,72	164,64
1A030232	4.00x5	■	8002929064189	6	35	-	-	-	13,72	82,32
1A160392	4.00x10	■	8002929121905	12 Promobox	5	-	-	-	21,82	261,84
1A100154	6.00x10	■	8002929092397	8 Promobox	5	-	-	-	31,31	250,48



73022706	2.00x50	■	8002929050984	-	-	50	0,37	0,74	-	37,00
73022206	2.00x100	■	8002929039156	-	-	32	0,35	0,70	-	70,00
73022306	3.00x100*	■	8002929039163	-	-	28	0,35	1,05	-	105,00
73023006	4.00x50	■	8002929051318	-	-	40	0,37	1,48	-	74,00
73022406	4.00x100	■	8002929039170	-	-	16	0,35	1,40	-	140,00
73022606	6.00x100	■	8002929040947	-	-	18	0,35	2,10	-	210,00
73023406	8.00x50	■	8002929051592	-	-	16	0,37	2,96	-	148,00
73022806	8.00x100	■	8002929040961	-	-	12	0,35	2,80	-	280,00

\* Piegare in rotoli da 1,5 m – Folded in 1,5 m rolls – Pliéés en rouleaux de 1,5 m – Dobladas en rollos de 1,5 m – Auf 1,5 m Breite gefaltet

Le reti in altezza 2 m e 4 m vengono piegate ed i rotoli risultano alti 1 m. Le reti in altezza 6 m e 8 m vengono piegate più volte ed i rotoli risultano alti 2 m.

2 m and 4 m high products are folded in 1 m rolls. 6 m and 8 m high products are folded in 2 m rolls.

Les hauteurs 2 m e 4 m sont pliées en rouleaux de 1 m. Les hauteurs 6 m e 8 m sont pliées en rouleaux de 2 m.

Las alturas de 2 m y 4 m están dobladas en rollos de 1 m. Las alturas de 6 m y 8 m están dobladas en rollos de 2 m.

Die Abmessungen 2 m und 4 m sind auf 1 m Breite gefaltet. Die Abmessungen 6 m und 8 m sind auf 2 m Breite gefaltet.

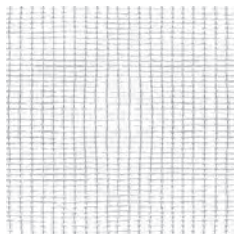

 **IRIDIUM PERLA**

**Rete antigrandine foto-selettiva color perla.**  
Rete in HDPE che agisce sullo sviluppo della pianta, modificando a livello quali-quantitativo la luce disponibile. Genera una maggior diffusione della luce e una miglior distribuzione sulle piante. Migliora la qualità e la pezzatura dei frutti. Agisce attivamente nella protezione delle colture da avversità atmosferiche. Dotata di cimose laterali e centrali per assicurare robustezza e resistenza.

**Photo-selective, hailstone-proof mesh.**  
Pearl coloured, mesh in HDPE that acts on plant development, modifying the quality-quantity level of light available. It generates greater diffusion of light and greater distribution on the plants and it improves the quality and weight of the fruit. It actively protects crops from bad weather. Equipped with central and side selvage to ensure strength and resistance.

**Filet anti-grêle photo-sélectif.**  
Filet de couleur perle en HDPE agissant sur le développement de la plante en modifiant son niveau de qualité et quantité de lumière disponible. Il génère sur les plantes une plus grande diffusion et une meilleure répartition de la lumière et améliore la qualité et la dimension des fruits. Doté de lisières latérales et centrales, il protège les cultures contre les conditions climatiques défavorables, la grêle et le vent.

**Malla antigranizo fotoselectiva color perla.**  
Malla de HDPE que interviene en el crecimiento de la planta, modificando el nivel de calidad y cantidad de la luz disponible. Genera una mayor difusión de la luz y una mejor distribución sobre las plantas. Mejora la calidad y el calibre de los frutos. Interviene activamente en la protección de los cultivos contra las inclemencias atmosféricas. Dotada de refuerzos laterales y centrales para asegurar robustez y resistencia.

**Foto-selettives Hagelschutznetz, Perle Farbe.**  
Netz aus HDPE, das auf die Entwicklung der Pflanze agiert, sie ändert das verfügbare Licht auf dem qualitativen und quantitativen Ebene. Es generiert eine größere Verbreitung des Lichts und eine bessere Verteilung auf den Pflanzen, sie verbessert die Qualität und die Scheckung der Früchte, sie handelt aktiv in dem Schutz der Pflanzungen gegen dem atmosphärischen Unglück. Sie ist mit lateralen und zentralen Webkanten ausgestattet.

Cod.	m	-	EAN	N° x	x	x	€ m <sup>2</sup>	€ m	€	€
1A150330	4.00x5	<input type="checkbox"/>	8002929117335	6	24	-	-	-	22,80	136,80

 **UTILFENDER**

UV TREATED

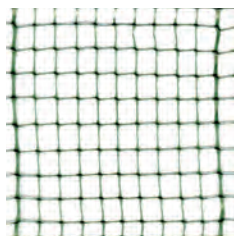

6x7 mm



**Antigrandine multiuso.**  
Rete in PP a maglia stabile che, utilizzata su strutture di sostegno, protegge gli ortaggi dalla grandine e dalla voracità degli uccelli. Stesa sotto agli alberi, può essere utilizzata anche per la raccolta di nocciole, olive o foglie.

**Multipurpose anti-hail net.**  
An extruded PP net, more rigid and convenient, to protect plants from hail and bird attacks. If laid on the ground under trees, it is also useful for harvesting hazelnuts, olives or leaves.

**Anti-grêle et multi usage.**  
Maille en PP stable qui peut être tendue sur des structures pour protéger les légumes de la grêle et des oiseaux. Résistante et économique, UTILFENDER est une protection multi usage parfaite.

**Antigranizo multiuso.**  
Malla fabricada en PP y con estructura rígida que, colocada sobre soportes, protege del granizo y de los pájaros. Resistente y económica, se puede utilizar también en el suelo para la recogida de fruta pequeña, como aceitunas o avellanas.

**Mehrzweck Hagelschutznetz.**  
Ein extrudiertes PP-Netz, etwas steifer und besser geeignet um Pflanzen vor leichtem Hagel und Vogelangriffen zu schützen. Wenn es auf den Boden unter Bäume gelegt wird, kann es auch als Sammelnetz für Haselnüsse, Oliven oder Blättern verwendet werden.

Cod.	m	-	EAN	N° x	x	x	€ m <sup>2</sup>	€ m	€	€
73320206	2.00x10	<input checked="" type="checkbox"/>	8002929035608	6	24	-	-	-	12,05	72,30
73320406	4.00x5	<input checked="" type="checkbox"/>	8002929035615	6	24	-	-	-	12,05	72,30



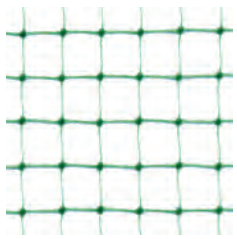

10x12 mm

**Antiuccelli efficace e leggera.**

Rete a maglia quadrata in PP che, posata su strutture o direttamente sulle colture, protegge semine, ortaggi e alberi da frutta dall'attacco degli uccelli, senza nuocere loro in alcun modo.

**Light and effective anti-bird mesh.**

Extruded square mesh which can be applied directly over plants or seed beds. It protects vegetables, fruits and seeds from birds. Lightweight but resistant, it is easy to install and long lasting.

**Filet anti-oiseaux efficace et léger.**

Filet à maille carrée en PP. Appliqué sur les structures ou directement sur les cultures, il protège les plantations, les légumes et les arbres fruitiers de l'attaque des oiseaux, sans les blesser.

**Antipájaros eficaz y ligera.**

Malla cuadrada, ligera y fina que puede colocarse sobre estructuras de soporte o directamente encima de los cultivos para impedir que los pájaros picoteen las plantas, las hortalizas o los frutos, sin ser nocivo para ellos.

**Leichtes und effektives Vogelschutznetz.**

Extrudiertes Netz, das direkt über die Pflanzen oder das Saatgut gelegt wird. Er schützt Gemüse, Früchte und Samen vor Vögeln. Leicht, aber beständig, ist es einfach zu installieren und langlebig.



Cod.	m	-	EAN	N° x	x	x	€ m <sup>2</sup>	€ m	€	€
55030046	2.00x5	■	8002929035516	24	48	-	-	-	3,07	73,68
55030106	2.00x10	■	8002929035523	18	36	-	-	-	4,73	85,14
1A150438	2.00x10	■	8002929035523	12	30	-	-	-	4,73	56,76
55032289	4.00x5	■	8002929035530	18	36	-	-	-	4,73	85,14
55032348	4.00x10	■	8002929035547	12	28	-	-	-	8,88	106,56
55033435	5.00x8	■	8002929035554	12	28	-	-	-	8,88	106,56
1A090427	2.00x5	■	8002929090706	42	48	-	-	-	2,46	103,32
1A090428	2.00x10	■	8002929090713	24	48	-	-	-	3,79	90,96
1A090429	4.00x5	■	8002929090720	24	48	-	-	-	3,79	90,96
1A090430	4.00x10	■	8002929090737	12	48	-	-	-	7,10	85,20
1A100499	4.00x25	■	8002929094964	10	16	-	-	-	16,98	169,80
1A090431	5.00x8	■	8002929090744	12	48	-	-	-	7,10	85,20
56153009	2.00x500	■	8002929008343	-	-	45	-	-	-	183,86
56303009	4.00x250	■	8002929008404	-	-	28	-	-	-	183,86
56353009	4.80x200	■	8002929008411	-	-	16	-	-	-	176,50

Le altezze 4 m sono piegate in rotoli da 1 m; le altezze 4.80 m sono piegate in rotoli da 1,20 m – 4 m high products are folded in 1 m rolls; 4.80 m high products are folded in 1.20 m rolls – Les hauteurs 4 m sont pliées en rouleaux de 1 m; les hauteurs 4.80 m sont pliées en rouleaux de 1.20 m – Las alturas de 4 m están dobladas en rollos de 1 m; las alturas de 4.80 m están dobladas en rollos de 1.20 m – Die Abmessungen 4 m sind auf 1 m Breite gefaltet. Die Abmessungen 4.80 m sind auf 1.20 m Breite gefaltet.

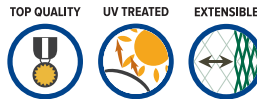

20x20 mm \*\*\*

**Estensibile ed adattabile.**

La maglia romboidale si può allungare o allargare secondo necessità, per coprire e proteggere dalla voracità degli uccelli anche gli alberi da frutta con chioma irregolare.

**Expandable bird netting.**

This extruded diamond mesh is used to prevent birds from pecking at seeds and fruit. The flexible structure makes it ideal for stretching over trees with irregular shapes.

**Filet anti-oiseaux extensible.**















La maille de forme rhomboïdale lui garantit une grande flexibilité: vous pouvez l'étirer ou l'élargir au besoin, pour couvrir et protéger les arbres fruitiers aux formes irrégulières, de la voracité des oiseaux.

**Extensible y económica.**

Su forma romboidal ofrece una gran flexibilidad: se puede extender y alargar según las necesidades para cubrir y proteger árboles frutales con formas irregulares.

**Flexibles Vogelnetz.**

Dieses extrudierte Netz mit einer diamantförmigen Masche wird als Vogelschutznetz für Samen und Früchte verwendet. Durch die flexible Struktur ideal um es über Bäume mit unregelmäßigen Formen zu legen.

Cod.	m	-	EAN	N° x 	 x 	 x 	€ m <sup>2</sup>	€ m	€ 	€ 	
55035046	2.00x5		8002929043238	24	77	-	-	-	2,57	61,68	
55035106	2.00x10		8002929043245	24	42	-	-	-	3,97	95,28	
1A100159	4.00x6		8002929092441	24	42	-	-	-	4,17	100,08	
1A100160	4.00x12		8002929092458	18	25	-	-	-	7,82	140,76	
											
56992006	~2.00x500*		8002929030009	2	27	-	-	-	103,12	206,24	
56991606	~4.00x250**		8002929028907	2	27	-	-	-	103,12	206,24	

\* H max 2 m - 1.000 m<sup>2</sup>\*\* H max 4 m - 1.000 m<sup>2</sup>

\*\*\* Dimensioni della rete stesa, perfettamente aperta – Net dimensions when perfectly opened – Dimensions du filet tendu, parfaitement ouvert – Medidas de la malla extendida, perfectamente abierta – Maße des ausgebreiteten Netzes, vollständig geöffnet

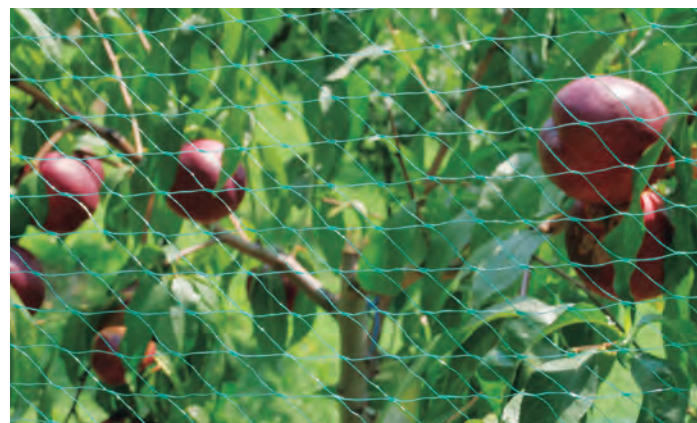

**MICROFENDER**

TOP QUALITY

UV TREATED

STRONG

**Rete anti-insetti.**

Rete in monofilo in polietilene bianca trasparente a maglie molto strette. La capacità delle reti antiafide di difendere le colture in ambiente protetto evitando l'utilizzo di pesticidi permette una forma di prevenzione integrata migliorando qualitativamente il raccolto. La rete viene applicata per creare dei microtunnel con protezione terra-cielo per la coltivazione di zucchine, zucca, cavolo, carota e lattuga o su serre difendendo le colture da **afidi, mosca bianca, Drosophila Suzukii, Bemisia Tabaci, mosca del cavolo e Tuta Absoluta.**

**Anti-insect mesh.**

Very tight, single thread mesh in white, transparent polyethylene. The mesh creates a protected environment from aphid, thus avoiding the use of pesticides and improving the quality of the harvest. The mesh is applied to create micro-tunnels with a ground-sky protection to grow courgettes, pumpkins, cabbage or in greenhouses to defend the crops against **aphids, whitefly, Drosophila Suzukii, Bemisia Tabaci, cabbage root fly and Tuta Absoluta.**

**Filet anti-pucerons.**









Filet en monofilament de polyéthylène blanc transparent à maille serrée. La capacité des filets anti-pucerons est de préserver les cultures dans un environnement protégé en évitant l'utilisation de pesticides. Il offre une forme de prévention intégrée tout en améliorant la qualité de la récolte. Le filet est utilisé pour la création de micro-tunnel avec une protection terre et ciel pour la culture des courgettes, citrouilles, choux, carottes et laitues ou sur des serres protégeant les cultures des **puccerons, mouches blanches, de la Drosophila Suzukii, la Bemisia Tabaci, la mouche du chou et la Tuta Absoluta.**

**Malla antiplagas.**

Malla en monofilamento de polietileno transparente de luz muy pequeña. Las mallas antiplagas resultan un buen sistema de prevención integrada que permite mejorar la calidad de la cosecha. La malla está diseñada para crear un microtúnel con protección tierra-techo para el cultivo de calabacín, calabaza, col, zanahoria, lechuga o para invernaderos con protección frente al **pulgón, la mosca blanca, la Drosophila Suzuki, la mosca de la col, entre otros.**

**Insektenschutznetz.**

Sehr engmaschiges Monfilgewebe aus weißem, transparenten Polyethylen. Das Netz schützt die Pflanzen vor Blattläusen, wodurch die Verwendung von Pestiziden vermieden und die Qualität der Ernte verbessert wird. Das Netz wird verwendet um Mikro-Tunnel mit einem Boden-Himmel Schutz zu schaffen, damit Zucchini, Kürbisse, Kohl, Karotten und Salat wachsen können oder in Gewächshäusern, um die Pflanzen gegen **Blattläuse, weiße Fliegen, Drosophila Suzukii, Bemisia Tabaci, Kohlwurzeln und Tomatenminiermotten** zu schützen.

Cod.	m	-	EAN	N° x 	 x 	 x 	€ m <sup>2</sup>	€ m	€ 	€ 	
1A070478	2.00x5	<input checked="" type="checkbox"/>	8002929082213	6	24	-	-	-	21,00	126,00	
											
73026501	2.00x100	<input checked="" type="checkbox"/>	8002929031242	-	-	-	1,84	3,67	-	367,20	
1A150346	3.00x100	<input checked="" type="checkbox"/>	8002929117427	-	-	-	1,83	5,48	-	547,74	



# QUADRA 05 (treeguard)

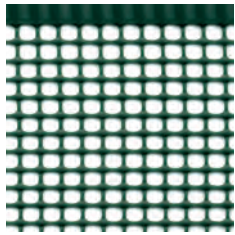
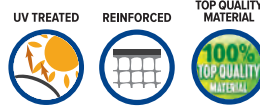

5x5 mm



**Protezione giovani piante.**  
Rete in plastica a maglia quadra, indicata per la protezione di giovani piante da piccoli animali e dai danni dei decespugliatori. Gamma completa di TENAX QUADRA 05 a pag. 11. Altre misure per uso professionale, sono disponibili a richiesta (gamma TG).

**Protection for young plants.**  
Plastic square mesh, suitable for protecting young plants from small animals. The complete range of TENAX QUADRA 05 at page 11. Other TG options for a professional use are available upon request.

**Protection des jeunes plantes.**  
Filet en plastique à maille carrée, indiqué pour la protection des jeunes plantes contre les petits animaux et le dommage des débroussailluses. Gamme complète de TENAX QUADRA 05 page 11. Pour une utilisation professionnelle, d'autres options sur demande.

**Protección de plantas jóvenes.**  
Malla plástica, indicada para proteger las plantas jóvenes de los pequeños animales y del ataque de los desbrozadores. Gama completa de TENAX QUADRA 05 en la página 11. Otras medidas para uso profesional, disponibles por encargo (gama TG).

**Schutz Für Jungpflanzen.**  
Gitter aus Kunststoff mit quadratischer Masche zum Schutz von Jungpflanzen vor Kleintieren. Das komplette Sortiment von TENAX QUADRA 05 siehe Seite 11. Auf Anfrage sind weitere TG Optionen verfügbar.



Cod.	m	-	EAN	N° x	x	x	€ m <sup>2</sup>	€ m	€	€
1A030230	0.50x5		8002929064165	12	24	-	-	-	8,55	102,60
1A030189	0.50x30		8002929063748	-	-	50	1,60	0,80	-	24,00



Con contametri  
With meter counter  
Avec compteurs métriques  
Con cinta métrica  
Mit Meterzähler

# S 38 (mole net)

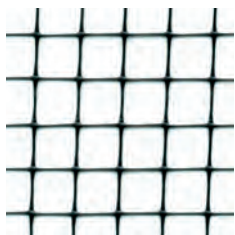

12x12 mm

**Rete da interro contro le talpe.**  
Rete protettiva da interro orizzontale o verticale per difendere orti e colture dai danni causati dalle talpe.

**Underground anti-mole mesh.**  
The TENAX S 38 mole-net mesh is lightweight, easily shaped and durable. It is not damaged by contact with the ground and provides effective protection for your vegetable garden.

**Filet souterrain anti-taupes.**  
Le filet TENAX S 38 (anti-taupes), léger, facilement façonnable et très résistant, ne s'abîme pas au contact du sol et offre une protection efficace pour votre jardin et votre potager.

**Malla para proteger raíces.**  
La malla TENAX S 38, ligera, fácilmente moldeable y muy resistente, no se daña estando en contacto con la tierra y garantiza una protección eficaz para el huerto y el jardín.

**Maulwurfgitter im Boden.**  
Das TENAX S 38 Maulwurfschutz-Gitter ist leicht, einfach zuzuschneiden und langlebig. Er wird durch den Bodenkontakt nicht beschädigt und bietet einen wirksamen Schutz für Ihren Gemüsegarten.



MORE INFO

Cod.	m	-	EAN	N° x	x	x	€ m <sup>2</sup>	€ m	€	€
1A120115	1.00x200		8002929102652	-	-	32	0,61	0,61	-	122,00
1A120114	2.00x200		8002929102645	-	-	16	0,61	1,22	-	244,00





**MANUTENZIONE  
GIARDINO  
E CASA**

**GARDEN  
AND HOME  
CARE**

**ENTRETIEN  
MAISON  
ET JARDIN**

**MANTENIMIENTO  
DE LA CASA  
Y EL JARDÍN**

**INSTANDHALTUNG  
HAUS  
UND GARTEN**

Trallicci e mini tutori	Trellises and mini stakes	Treillis et mini tuteurs	Enrejados y minitutores	Gitter und Mini-Stützen	116
Borsoni da giardino	Garden bags	Sacs de jardin	Bolsas de jardín	Gartentaschen	119
Reti per grondaie e tombini	Meshes for gutters and manholes	Filets pour gouttières et égouts	Mallas para canalones y alcantarillas	Gitter für Dachrinnen und Abflüsse	122
Teli e film protettivi	Protective films and covers	Toiles et films de protection	Tejidos y films de protección	Abdeckungen und Schutzfolien	124
Zanzariere	Mosquito nets	Moustiquaires	Mosquiteras	Mückennetze	127



## Tralicci e mini tutori

Per sostenere la crescita di fiori rampicanti e decorare al tempo stesso pareti, balconi e terrazze, TENAX propone una linea completa di tralicci estensibili, in varie misure e colori.

## Trellises and mini stakes

TENAX has a range of expandable synthetic trellises which can be easily installed onto walls and columns, to support climbing flowers.

## Treillis et mini tuteurs

Comme support pour plantes grimpances et en même temps pour décorer murs, balcons et terrasses, TENAX offre une gamme complète de treillis extensibles, en plusieurs dimensions et couleurs.

## Enrejados y minitutores

Para la sujeción de plantas trepadoras y la decoración al mismo tiempo de paredes, balcones o terrazas, TENAX presenta una línea completa de celosías extensibles en varias medidas y colores.

## Gitter und Mini-Stützen

TENAX hat eine Vielzahl an Kunststoffrankhilfen, die leicht an Wänden und Säulen installiert werden können um Kletterpflanzen zu stützen.

**TREPLAS**

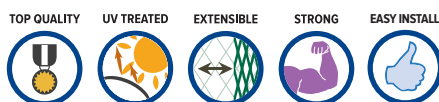

5



15x15 cm

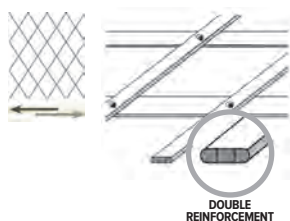

DOUBLE REINFORCEMENT

### Traliccio estensibile.

Ideale per il sostegno a muro di fiori rampicanti. Leggero e resistente, grazie al doppio rinforzo interno presente in ogni listello, rappresenta un supporto economico e decorativo. Si adatta facilmente a spazi diversi, si installa in un attimo e non necessita di alcuna manutenzione.

### Adaptable trellis.

Ideal for supporting climbing flowers and plants. Lightweight yet strong and durable, thanks to its double internal reinforcement strip, it can be easily adapted to fit different spaces. Easy to install and maintain.

### Treillis extensible.

Grille synthétique idéale pour soutenir les fleurs grimpances: légère et résistante, grâce à une double armature interne dans chaque bande. C'est un support économique et décoratif. Il s'adapte facilement à différents espaces, s'installe en un clin d'œil et ne nécessite aucun entretien.

### Celosía extensible.

Celosía de plástico extensible para sujetar las plantas trepadoras en las paredes. Ligera y resistente gracias al doble refuerzo interno en cada listón, es una solución económica y decorativa. Se adapta fácilmente a cualquier sitio y no necesita mantenimiento.

### Flexible Rankgitter.

Ideal zur Unterstützung von Kletterblumen und Pflanzen. Leicht, jedoch robust und langlebig dank seines doppelten inneren Verstärkungstreifens kann es einfach an verschiedene Größen angepasst werden. Einfach anzulegen und zu pflegen, ist es in verschiedenen Größen und Farben erhältlich.

	Cod.	m	-	EAN	N° x	x	x	€ m <sup>2</sup>	€ m	€	€
<b>NEW</b>	1A120296	0.50x2	■	8002929104229	10	60	-	-	-	4,38	43,80
<b>NEW</b>	1A120305	0.50x2	■	8002929104311	10	60	-	-	-	4,38	43,80
<b>NEW</b>	1A120297	1.00x1	■	8002929104236	10	78	-	-	-	4,38	43,80
<b>NEW</b>	1A120303	1.00x1	□	8002929104298	10	78	-	-	-	4,38	43,80
<b>NEW</b>	1A120298	1.00x2	■	8002929104243	5	100	-	-	-	8,76	43,80
<b>NEW</b>	1A120292	1.00x2	■	8002929104182	5	100	-	-	-	8,76	43,80
<b>NEW</b>	1A120290	1.00x2	□	8002929104168	5	100	-	-	-	8,76	43,80
<b>NEW</b>	1A120299	1.00x3	■	8002929104250	5	75	-	-	-	13,13	65,65
<b>NEW</b>	1A120291	1.00x3	□	8002929104175	5	75	-	-	-	13,13	65,65

**COROLLA**



4.2x4.2 cm



**Rete per rampicanti.**  
Rete in PE adatta a sostenere la crescita di fiori a parete o in vaso, quale alternativa economica ai tralici tradizionali. Può essere usata anche a terra come delimitazione.

**Mesh for climbers.**  
PE mesh suitable to support flower growth on walls and in pots, as an inexpensive alternative to traditional trellises. It can also be used on the ground as edging.

**Soutenir les grimpants.**  
Filet en PE, indiqué pour soutenir la croissance des fleurs murales ou en pots, alternative plus économique par rapport aux treillis traditionnels. Il peut également être utilisé au sol comme bordure.

**Malla para trepadoras.**  
Malla de PE ideal como soporte para las plantas trepadoras tanto en las macetas como en las paredes y como alternativa económica a los tutores tradicionales. Puede utilizarse también como bordura.

**Rankgitter für Kletterpflanzen.**  
PE-Gitter als Kletterhilfe für Blumen an Wänden und in Töpfen, als kostengünstige Alternative zu herkömmlichen Stützgittern. Es kann auch als Einzäunung verwendet werden.

Cod.	m	-	EAN	N° x	x	x	€ m <sup>2</sup>	€ m	€	€
72180298	0.50x5	■	8002929039101	12	24	-	-	-	9,17	110,04
72022416	1.00x5	■	8002929039071	6	24	-	-	-	14,55	87,30
62205308	0.50x30	■	8002929040251	-	-	24	1,97	0,99	-	29,55
62210308	1.00x30	■	8002929040312	-	-	12	1,97	1,97	-	59,10
62210305	1.00x30	■	8002929040268	-	-	12	1,97	1,97	-	59,10



**Accessori Accessories Accessoires Accesorios Zubehör**

Cod.	m	-	EAN	N° x	x	x	€ m <sup>2</sup>	€ m	€	€
------	---	---	-----	------	---	---	------------------	-----	---	---

**CLIPS DI FISSAGGIO per Corolla – FIXING CLIPS for Corolla – CLIPS DE FIXATION pour Corolla – CLIPS DE FIJACION para Corolla – BEFESTIGUNGS-SET für Corolla**

Confezione da 6 pezzi – Pack of 6 pieces – Sachet de 6 pièces – Envasado en bolsas de 6 unidades – Packung mit 6 Stk.



3A021852	3,5 cm	■	5010453852007	12	-	-	-	-	2,90	34,80
----------	--------	---	---------------	----	---	---	---	---	------	-------

## STICK UP



**Mini tutori da vaso.**  
Bastoncini in plastica di piccolo diametro, per sostenere la crescita di piccole piante in vaso.

**Small sticks ideal for pots.**  
Plastic sticks with a narrow diameter, they are ideal for supporting the growth of small potted plants and flower beds.

**Petits tuteurs pour vases.**  
Tuteurs en plastique de petit diamètre, pour soutenir les petites plantes en pots.

**Poste pequeño para floreros.**  
Bastoncillos de plástico de diámetro pequeño, para sujetar pequeñas plantas en macetas.

**Kleine Stäbe ideal für Töpfe.**  
Kunststoffstäbe mit einem kleinem Durchmesser. Ideal zur Unterstützung des Wachstums von kleinen Topfpflanzen und in Blumenbeeten.

	Cod.	m	-	EAN	N° x	x	x	€ m <sup>2</sup>	€ m	€	€
20 pcs	1A040352	0.45		8002929068958	12	-	-	-	-	2,39	28,68
20 pcs	1A150312	0.45		8002929117199	12	-	-	-	-	2,39	28,68
20 pcs	1A040353	0.60		8002929068965	12	-	-	-	-	2,75	33,00
20 pcs	1A150313	0.60		8002929117205	12	-	-	-	-	2,75	33,00

## BAMBOO STICK



**Bastoncini in bamboo naturale.**  
In colore verde per piccole piante in vaso.

**Plant sticks for pots.**  
Made of green natural bamboo.

**Tuteurs pour plantes en pot.**  
Réalisés en bambou naturel vert.

**Bastoncillos de bambú natural.**  
De color verde para pequeñas plantas de maceta.

**Pflanzenstäbe für Töpfe.**  
Hergestellt aus grünem natürlichen Bambus.

	Cod.	m	-	EAN	N° x	x	x	€ m <sup>2</sup>	€ m	€	€
15 pcs	1A160279	0.50		8002929120922	24	-	-	-	-	0,85	20,40

## TRELL UP

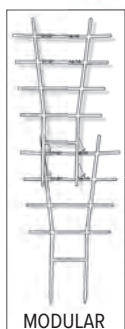

**Sostegno a scala.**  
In plastica, a forma di scaletta capovolta, si utilizza nelle fioriere per sostenere la crescita iniziale di fiori a cespuglio. I moduli sono agganciabili tra loro per aumentare l'altezza del sostegno.

**Sustaining ladder.**  
Plastic plant support, designed to be used in pots to support the initial growth of flowers and shrubs. Modular, they can be connected one another to provide higher support.

**Echelle de soutien.**  
Fabriqué en plastique, en forme d'échelle retournée, utilisée dans des pots pour soutenir la croissance des fleurs et arbustes. Les barreaux horizontaux peuvent s'accrocher entre eux afin d'augmenter la hauteur de soutien.

**Escalera para sujetar.**  
Estructura de plástico con forma de escalera invertida que se utiliza en los floreros para sujetar flores y arbustos en su inicio de crecimiento. Los módulos pueden acoplarse para aumentar la altura del soporte.

**Stützleiter.**  
Stützgitter aus Kunststoff für die Unterstützung des Anfangswachstums in Blumentöpfen und für kleine Sträucher. Modular: können für einen besseren Halt miteinander verbunden werden.

	Cod.	m	-	EAN	N° x	x	x	€ m <sup>2</sup>	€ m	€	€
2 pcs	99531400	0.43		5010453889003	12	-	-	-	-	2,33	27,96





### Borsoni da giardino

I borsoni facilitano la raccolta delle foglie secche e il loro trasporto. Sono disponibili in diversi materiali, in dimensioni o forme differenti, o sagomati specificatamente per l'inserimento nella carriola.

### Garden bags

Bags make it easier to collect dry leaves and transport them. Available in different material and sizes, also in a specific shape to be placed inside the wheelbarrow.

### Sacs de jardin

Les sacs facilitent la collecte des feuilles sèches et leur transport. Ils sont disponibles dans différents matériaux et différentes formes ou tailles, ou spécialement conçus pour être insérés dans la brouette.

### Bolsas para jardín

Las bolsas facilitan la recogida de las hojas secas y su transporte. Están disponibles en diferentes materiales, en dimensiones o formas diferentes, o adaptadas específicamente para introducirlas en la carretilla.

### Gartentaschen

Die Taschen erleichtern das Sammeln von Laub und dessen Transport. Sie sind in verschiedenen Materialien, in unterschiedlichen Dimensionen oder Formen erhältlich, sowie speziell zugeschnitten zum Einpassen in die Schubkarre.

## CARRYALL BAG *Designed by Tenax*

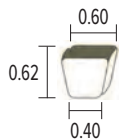

CAPACITY



157 L

#### Pop up per carriole.

Pop up bag in HDPE ad alto spessore. Da posizionare all'interno della carriola, per un migliore caricamento e scarico di arbusti, foglie e altro materiale. Aumenta di 4 volte la capacità di portata di una normale carriola.

#### Pop-up for wheelbarrows.

A very thick HDPE pop-up bag. To be placed inside the wheelbarrow to allow shrubs, leaves and other material to be better loaded and unloaded. Multiplies the capacity of a normal wheelbarrow by 4.

#### Sac à brouette.

Pop up bag en PEHD de grande épaisseur. À placer à l'intérieur de la brouette pour un meilleur chargement et déchargement des arbustes, feuilles et autres matériaux. Augmente de 4 fois la capacité de charge d'une brouette normale.

#### Pop up bag para carretillas.

Bolsa tipo pop up en HDPE de elevado espesor. Se coloca dentro de la carretilla para aumentar la capacidad de carga y facilitar así la descarga de los arbustos, las hojas y otros materiales. Aumenta 4 veces la capacidad de carga de una carretilla normal.

#### Aufklapptasche für Schubkarren.

Eine sehr dicke HDPE Aufklapptasche. Um in die Schubkarre gelegt zu werden, damit Sträucher, Blätter und anderem Materialien besser be- und entladen werden können. Erhöht die Kapazität einer normalen Schubkarre um das Vierfache.

Cod.	m	-	EAN	N° x	x	x	€ m <sup>2</sup>	€ m	€	€
1A150114	-		8002929115584	12	50	-	-	-	8,10	97,20



5

# GLAMOUR BAG *Designed by Tenax*



## GLAMOUR SQUARE BAG



**Qualità premium.** Linea completa di bag in poliester top quality ad altissima resistenza. Resistono a carichi importanti e non vengono forati da rami e sterpaglie. Manici con cucitura super-rinforzata, colore in due nuance di grigio per una visual davvero d'impatto. Anche per uso cittadino.

**Glamour Square Bag.** Multiuso a base quadrata.

**Glamour Pop Up Bag.** Massima comodità. Con struttura a molla e autoportante.

**Glamour Stand Bag.** Massima capienza autoportante.

Dotata di anima rigida da inserire nel bordo superiore, per conferire una maggior rigidità e mantenere il borsone aperto.

**Premium quality.** Complete range of top quality, high strength polyester bags. Made of thick polyester, they resist heavy loads and are not perforated by twigs or undergrowth. Handles with super-reinforced stitching in two shades of grey for a truly visual impact. Also for urban use.

**Glamour Square Bag.** Multipurpose with a square base.

**Glamour Pop Up Bag.** Maximum comfort. With a freestanding spring structure.

**Glamour Stand Bag.** Maximum freestanding capacity. Supplied with a rigid core to be inserted into the upper edge, giving greater rigidity and keeping the bag open while loading and unloading leaves.

**Premium quality.** Gamme complète de sacs en polyester de haute qualité et de haute résistance. En polyester de grande épaisseur, ils résistent à de grosses charges et ne sont pas perforés par les branches et les broussailles. Poignées avec couture hautement renforcée, couleur en deux tons de gris pour un impact très visuel. S'utilise également en ville.

**Glamour Square Bag.** Polyvalent avec une base carrée.

**Glamour Pop Up Bag.** Confort maximum. Avec une structure à ressort et autoportante.

**Glamour Stand Bag.** Grande capacité autoportante. Dotée d'une âme rigide à insérer dans le bord supérieur, pour lui donner une meilleure rigidité et maintenir le sac ouvert.

**Gama de bolsas de jardín y terraza de alta calidad.** Línea completa de bolsas en poliéster de alta calidad y alta resistencia. En poliéster de elevado espesor para resistir las cargas y evitar roturas por ramas u otros elementos punzantes. Se presenta con asas con costuras reforzadas para asegurar su resistencia y en dos tonalidades de gris para un aspecto más moderno. Ideal incluso para uso en ciudad.

**Glamour Square Bag.** Multiusos con base cuadrada. **Glamour Pop Up Bag.** Máxima comodidad. Con estructura tipo muelle.

**Glamour Stand Bag.** Máxima capacidad. Dotada de varillas rígidas para insertar en el borde superior, para darle mayor rigidez y mantener la bolsa abierta durante la recogida de hojas.

**Premium Qualität.** Komplettes Sortiment an hochwertigen, hochfesten Polyesteraschen. Hergestellt aus dickem Polyester, widerstehen sie schweren Lasten und werden von Zweigen oder Unterholz nicht durchlöchert. Griffe mit super-verstärkten Nähten in zwei Grautönen für eine wirklich visuelle Wirkung. Auch für den urbanen Einsatz.

**Glamour Square Bag.** Mehrzwecktasche mit quadratischer Grundfläche. **Glamour Pop Up Bag.** Maximaler Komfort. Freistehenden Federstruktur. **Glamour Stand Bag.** Maximale freistehende Kapazität. Freistehenden Struktur. Mit einem starren Kern, der im oberen Rand eingesetzt wird. Dies ergibt eine höhere Steifigkeit und hält die Tasche beim Befüllen und Entladen von Blättern offen.

## GLAMOUR POP UP BAG



## GLAMOUR STAND BAG



Cod.	m	-	EAN	N° x		€ m <sup>2</sup>	€ m	€	€
------	---	---	-----	------	--	------------------	-----	---	---

## GLAMOUR SQUARE BAG 90 L

1A150175	0.42x0.42x0.50	■	8002929116178	20	50	-	-	-	9,87	197,40
----------	----------------	---	---------------	----	----	---	---	---	------	--------

## GLAMOUR POP UP BAG 120 L

1A150174	ø 0.50x0.62	■	8002929116161	12	28	-	-	-	12,38	148,56
----------	-------------	---	---------------	----	----	---	---	---	-------	--------

## GLAMOUR STAND BAG 250 L

1A150173	ø 0.65x0.75	■	8002929116154	20	32	-	-	-	10,30	206,00
----------	-------------	---	---------------	----	----	---	---	---	-------	--------

## GLAMOUR SQUARE BAG



# SKIP BAG MAXI



CAPACITY



250 L

**Formato maxi.**

Ampio borzone per la raccolta di foglie, rametti, erba e ogni altro residuo da giardino. Dotato di maniglie resistenti e di anima rigida da inserire nel bordo superiore, per conferire una maggior rigidità e mantenere il borzone aperto durante il carico e lo scarico delle foglie.

**Oversized.**

Big bag to collect leaves, branches, grass and any garden residues. Equipped with resistant handles. Supplied with a rigid core to be inserted into the upper edge, giving greater rigidity and keeping the bag open while loading and unloading leaves.

**Format maxi.**

Grand sac pour la collecte des feuilles, des brindilles, de l'herbe, et de tout autre détritrus de jardin. Equipé de poignées résistantes et d'une âme rigide à insérer dans le bord supérieur, pour lui donner une meilleure rigidité et maintenir le sac ouvert lors du chargement et du déchargement.

**Recogida de hojas en formato maxi.**

Bolsa de gran tamaño para la recogida de hojas, ramas, hierba o cualquier residuo del jardín. Dispone de asas resistentes. Dotada de varillas rígidas para insertar en el borde superior, para darle mayor rigidez y mantener la bolsa abierta durante la recogida de hojas.

**Überdimensional.**

Große Tasche, um Blätter, Zweige, Gras und alle anderen Gartenreste einzusammeln. Ausgestattet mit stabilen Griffen. Mit einem starren Kern, der im oberen Rand eingesetzt wird. Dies ergibt eine höhere Steifigkeit und hält die Tasche beim Befüllen und Entladen von Blättern offen.

Cod.	m	-	EAN	N° x	x	x	€ m <sup>2</sup>	€ m	€	€
1A110420	ø 0.65x0.75	■	8002929099716	10	88	-	-	-	8,90	89,00

# GARDEN BAG



CAPACITY



115 L

**Pop up bag.**

Con struttura a molla e autoportante, è leggera ma resistente.

**Pop up bag.**

With a spring and self-supporting structure, it is light but resistant.

**Sac pop up.**

Avec une structure à ressort et autoportant, il est léger mais résistant.

**Bolsa pop up.**

Bolsa con estructura con muelle rígido. Ligera y resistente.

**Aufklappbare Taschen.**

Mit Einer Feder selbsttragender Struktur und sie ist leicht.

Cod.	m	-	EAN	N° x	x	x	€ m <sup>2</sup>	€ m	€	€
3A042766	ø 0.50x0.6	■	5010453324917	20	-	-	-	-	7,85	157,00

SKIP BAG MAXI



GARDEN BAG





## Reti per grondaie e tombini

Le reti per grondaie TENAX impediscono alle foglie di depositarsi all'interno delle gronde mantenendole sempre pulite e permettendo il normale deflusso dell'acqua piovana.

## Meshes for gutters and manholes

Tenax tubular net prevents leaves from blocking the gutters, it keeps them clean and ensures a perfect flow of rain water.

## Filets pour gouttières et égouts

Les filets de gouttière TENAX empêchent les feuilles de se déposer dans les gouttières, les gardant toujours propres, permettant ainsi un écoulement normal de l'eau de pluie.

## Mallas para canalones y alcantarillas

Las mallas para canalones TENAX impiden que las hojas se depositen en los canalones manteniéndolos siempre limpios y permitiendo el normal drenaje del agua de la lluvia.

## Gitter für Dachrinnen und Abflüsse

Die TENAX Gitter für Dachrinnen verhindern die Ablagerung von Blättern in den Dachrinnen somit werden sie immer sauber gehalten und erlauben den normalen Abfluss des Regenwassers.

**LEVEX TUBE**



5

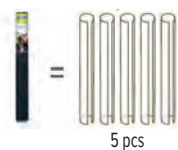
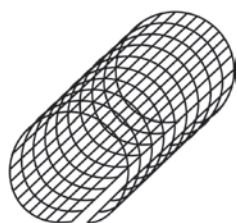

5 pcs



### Grondaie pulite.

Rete tubolare resistente agli agenti atmosferici, impedisce alle foglie l'occlusione delle grondaie. Si adatta a diametri di grondaia compresi tra 12 e 15 cm, è modulare e non necessita di manutenzione per diversi anni: un buon risparmio di tempo, fatica e spese.

- Non arrugginisce e non imputridisce.
- Impedisce agli uccelli di nidificare nella grondaia.
- Assicura il perfetto deflusso dell'acqua piovana.

### Clean gutters.

Tubular mesh resistant to atmospheric agents, it prevents leaves from blocking the gutters. It fits diameters of gutters from 12 to 15 cm, it is modular and does not require maintenance for many years: good savings in terms of time, labour and money.

- It does not rust or rot.
- It stops birds nesting in the gutters.
- It ensures perfect flow of rain water.

### Gouttières propres.

Filet tubulaire résistant aux intempéries pour empêcher les feuilles d'obstruer les gouttières. Il s'adapte à des gouttières d'un diamètre compris entre 12 et 15 cm, il est modulaire et ne nécessite d'aucun entretien pendant plusieurs années : une bonne économie en termes de temps, d'efforts et de frais.

- Ne rouille pas et ne pourrit pas.
- Empêche les oiseaux d'y faire leur nid.
- Assure un écoulement parfait des eaux de pluie.

### Canalones siempre limpios.

Malla tubular resistente a los agentes atmosféricos. Impide que las hojas atasquen los canalones. Se adapta a canalones con diámetros de entre 12 y 15 cm. Es modular y no necesita mantenimiento durante años: es un buen ahorro de tiempo, trabajo y dinero.

- No se corroe ni se pudre.
- Impide que los pájaros hagan nidos en los canalones.
- Ofrece un drenaje perfecto del agua de la lluvia.

### Saubere Rinnen.

Das rohrförmige Gitter ist beständig gegen Witterungseinflüsse und verhindert, dass Blätter die Dachrinnen verstopfen. Es passt auf Rinnengrößen von 12 bis 15 cm, ist modular und erfordert über viele Jahre keine Pflege: beträchtliche Einsparungen in Bezug auf Zeit, Arbeit und Geld.

- Es rostet oder verrottet nicht.
- Es hindert Vögel am Nisten in den Rinnen.
- Es garantiert einen perfekten Regenwasserabfluss.



VIDEO TUTORIAL

Cod.	m	-	EAN	N° x	x	x	€ m <sup>2</sup>	€ m	€	€
5 pcs 1A030211	1,00	■	8002929036742	6	24	-	-	-	15,97	95,82

**Reti per grondaie  
e tombini**

**Meshes  
for gutters  
and manholes**

**Filets  
pour gouttières  
et égouts**

**Mallas  
para canalones  
y alcantarillas**

**Gitter für  
Dachrinnen  
und Abflüsse**

**JOLLY**

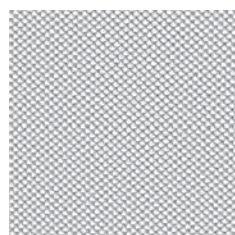

5x4 mm



**Bocche di lupo  
e tombini sgombri.**

Maglia romboidale molto fitta che impedisce a ghiaia, foglie e rametti di ostruire tombini, bocche di lupo o aperture di ventilazione.

**Clear drains.**

A very thick rhomboidal grid net which prevents gravel, leaves and twigs from blocking drains, basement windows and air vents.

**La maille plus serrée.**

Grâce à sa maille très fine de forme rhomboïdale, ce filet est généralement utilisé pour empêcher l'obstruction des ouvertures de ventilation ou de bouches d'aération par le gravier, les feuilles et les brindilles y compris dans les égouts.

**Alcantarillas limpias.**

Malla romboidal muy tupida que impide que la grava, las hojas y las ramas obstruyan alcantarillas, pequeñas hendiduras o aperturas de ventilación.

**Saubere Abflüsse.**

Ein sehr dickes rautenförmiges Gitter, das verhindert, dass Kies, Blätter und Zweige die Abflüsse, Kellerfenster und Lüftungsöffnungen verstopfen.

Cod.	m	-	EAN	N° x	x	x	€ m <sup>2</sup>	€ m	€	€
72060212	0.50x5		8002929000477	12	24	-	-	-	9,82	117,84
1A100295	0.50x5		8002929093400	12	24	-	-	-	9,82	117,84
72060116	1.00x5		8002929054678	6	24	-	-	-	15,86	95,16
1A070416	1.00x5		8002929081575	6	24	-	-	-	15,86	95,16
● 1A030149	0.50x30		8002929063311	-	-	32	2,79	1,40	-	41,85
● 1A030192	1.00x30		8002929063779	-	-	16	2,79	2,79	-	83,70
● 1A030191	1.00x30		8002929063762	-	-	16	2,79	2,79	-	83,70

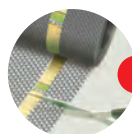

Con contametri  
With meter counter  
Avec compteurs métriques  
Con cinta métrica  
Mit Meterzähler



5



## Teli e film protettivi

Per i lavori di tinteggiatura, di manutenzione e bricolage, TENAX offre una linea di tessuti e film plastici indispensabili per la protezione di pavimenti, mobili e di ogni oggetto. Ideali in casa, sul terrazzo o in cortile, si utilizzano anche in garage o cantina, per coprire macchine ed utensili.

## Protective films and covers

For painting, maintenance and DIY, TENAX offers a range of fabrics and plastic films to protect floors, furniture and objects. Recommended at home, on terraces or courtyards, they can also be used in garages or cellars, to cover machinery and tools.

## Toiles et films de protection

Pour les travaux de peinture, d'entretien et de bricolage, TENAX propose une gamme de tissus et de films plastiques indispensables pour protéger les sols, les meubles et autres objets. Parfaits à la maison, sur la terrasse ou dans la cour, ils peuvent également être utilisés dans le garage ou au sous-sol, pour toute autre surface durant les travaux de bricolage.

## Tejidos y films de protección

Para las labores de pintura y de mantenimiento y bricolaje en general, TENAX ofrece una gama de tejidos y films de plástico muy eficaces para la protección del suelo, muebles y objetos de valor. Ideales en casa, terrazas o patios, se emplean también en garajes o sótanos para guardar máquinas y utensilios.

## Abdeckungen und Schutzfolien

Für Malerarbeiten, Instandhaltungen und für den Heimwerker bietet TENAX eine Reihe von Produkten für den Schutz von Fußböden, Möbeln und Gegenständen an. Empfohlen für das Haus, auf Terrassen oder Innenhöfen können sie aber auch in Garagen oder Kellern verwendet werden um Maschinen und Werkzeuge zu abzudecken.

5

# COVER ALL



## Telo protettivo multiuso.

Telo in polietilene, impermeabile e resistente, per riparare dalle intemperie mobili, attrezzi da giardino o legna accatastata.

## Protects wood and much more.

Polyethylene, impermeable and resistant covers to protect furniture, garden equipment and piles of wood from bad weather.

## Protège le bois et non seulement.

Toiles en polyéthylène, imperméables et résistantes, pour mettre les meubles, les outils de jardin ou le bois empilé à l'abri des intempéries.

## Protege la leña y mucho más.

Tejido de polietileno impermeable y resistente para proteger de la intemperie las máquinas de jardín o la leña amontonada.

## Schützt Holz und vieles mehr.

Aus Polyethylen, undurchlässige und widerstandsfähige Abdeckungen um Möbel, Gartengeräte und Holzstapel vor schlechtem Wetter zu schützen.

Cod.	m	-	EAN	N° x	x	x	€ m <sup>2</sup>	€ m	€	€
1A110422	1.50x6		8002929099730	10	54	-	-	-	11,70	117,00
1A160250	2.00x3		8002929120748	20	-	-	-	-	3,99	79,80
1A160251	3.00x4		8002929120755	15	-	-	-	-	7,99	119,85
1A160252	4.00x5		8002929120762	9	-	-	-	-	13,19	118,71



# NET FILM



18x18 mm – 90 μ



### Film rinforzato.

Doppio film in PE rinforzato all'interno con una rete in PP che ne aumenta la resistenza. Utile per proteggere pavimenti, tavoli e mobili durante i lavori di manutenzione della casa o per salvaguardare panchine e mobili da giardino durante la stagione invernale.

### Reinforced film.

Double PE film reinforced by a PP mesh to further strengthen it. Useful to protect floors, tables and furniture during home renovations or to protect garden benches and furniture during the winter season.

### Film renforcé.

Double film in PE renforcé à l'intérieur par un filet en PP qui en augmente la résistance. Utile pour protéger les planchers, les tables et les meubles lors de travaux d'entretien de la maison ou pour protéger les bancs et les meubles de jardin durant la saison hivernale.

### Film reforzado.

Film de doble capa en PE reforzado con una malla de plástico en PP que aumenta su resistencia. Ideal para cubrir y proteger suelos, herramientas, para trabajos de mantenimiento de la casa o para proteger bancos y muebles de jardín durante la estación invernal.

### Verstärkte Folie.

Zweilagige PE-Folie verstärkt mit einem PP-Gitter für eine höhere Reißfestigkeit. Nützlich um Böden, Tische und Möbel während der Hausrenovierung oder Gartenbänke und Möbel in der Wintersaison zu schützen.

Cod.	m	-	EAN	N° x	x	x	€ m <sup>2</sup>	€ m	€	€
1A030219	1.80x3		8002929064080	10	35	-	-	-	10,76	107,60
73000506	1.80x50		8002929012890	-	-	32	1,68	3,03	-	151,47

# COAT FILM PLUS

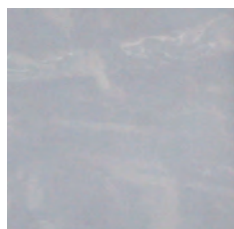

150 μ



### Film protettivo multiscopo ad alto spessore.

Impermeabile e trasparente, si utilizza per proteggere i mobili da giardino durante la stagione invernale. Utile come film protettivo per coprire qualsiasi altra superficie durante i lavori di manutenzione e bricolage o per proteggere dall'umidità e dalla polvere gli oggetti riposti in cantine e solai.

### High thickness protective film.

Waterproof and transparent, it is used to protect garden furniture during the winter season. Useful as a protective film to cover any other surface during maintenance and DIY work or to protect articles stored in basements and attics from moisture and dust.

### Film de protection de grosse épaisseur.

Étanche et transparent, il s'utilise pour couvrir les meubles de jardin durant la saison hivernale. Utile comme film protectif pour couvrir toute autre surface durant les travaux de manutention et de bricolage ou pour protéger les objets en dépôt dans la cave et grenier.

### Film protector de alto grosor.

Impermeable y transparente, se utiliza para proteger los muebles de jardín durante la estación invernal. Muy útil para cubrir cualquier superficie durante los trabajos de mantenimiento y bricolaje o para proteger de la humedad y del polvo los objetos guardados en trasteros y almacenes.

### Sehr dicke Schutzfolie.

Wasserdicht und transparent wird sie zum Schutz der Gartenmöbel im Winter eingesetzt. Nützlich als Schutzfolie um verschiedenste Oberflächen während Instandhaltungs- oder Heimwerkerarbeiten abzudecken oder um Gegenstände in Kellern und Dachböden vor Feuchtigkeit und Staub zu schützen.

Cod.	m	-	EAN	N° x	x	x	€ m <sup>2</sup>	€ m	€	€
1A070208	2.00x10*		8002929080011	6	9	-	-	-	21,86	131,16
1A070209	4.00x5*		8002929080028	6	9	-	-	-	21,86	131,16
1A060493	2.00x100*		8002929077608	-	-	12	0,75	1,51	-	150,96
73070040	4.00x100**		8002929059123	-	-	12	0,75	3,02	-	301,92
73070050	6.00x70***		8002929059130	-	-	12	0,75	4,53	-	317,02

\* Piegare in rotoli da 1 m – Folded in 1 m rolls – Pliéés en rouleaux de 1 m – Dobladas en rollos de 1 m – Auf 1 m Breite gefaltet

\*\* Piegare in rotoli da 2 m – Folded in 2 m rolls – Pliéés en rouleaux de 2 m – Dobladas en rollos de 2 m – Auf 2 m Breite gefaltet

\*\*\* Piegare in rotoli da 1,5 m – Folded in 1,5 m rolls – Pliéés en rouleaux de 1,5 m – Dobladas en rollos de 1,5 m – Auf 1,5 m Breite gefaltet

## PAINTER PAD

220 g/m<sup>2</sup>**Feltro impermeabile antiscivolo.**

Feltro rigenerato accoppiato ad un film, ideato per proteggere i pavimenti durante i lavori di tinteggiatura e i traslochi. Il feltro assorbe le gocce cadute accidentalmente; il film sottostante è impermeabile per trattenerle e trattato antisdrucchiolo per evitare scivolamenti di attrezzi ed operatori.

**Nuova qualità migliorata.**

**Felt for protection**

Absorbing pad made with regenerated cotton laminated with an impermeable gripping film. Ideal for protecting the floor while painting or moving. The cotton absorbs accidental drips and spills, while the impermeable film on the underside protects the floor.

**New improved quality.**

**Feutre de protection.**

Double d'un film imperméable, il est idéal pour protéger le plancher ou le parquet lors des travaux de peinture ou les déménagements. Le feutre absorbe les gouttes tombées accidentellement; la sous-couche est imperméable afin de les retenir et est antidérapante afin d'éviter le glissement des outils et des opérateurs.

**Qualité améliorée.**

**Fieltro de protección.**

Fieltro de algodón absorbente combinado con un film impermeable antideslizante que protege el suelo durante las labores de pintura y las mudanzas. El algodón absorbe las gotas caídas y el film impermeable evita que lleguen al suelo impidiendo también que resbalen objetos o personas.

**Nueva calidad mejorada.**

**Malervlies.**

Saugfähige Vliesmatte aus Regeneratfasern mit undurchlässiger Antirutschfolie. Ideal zum Schutz des Bodens bei Malerarbeiten oder beim Transport. Die Fasern nehmen Tropfen und Spritzer auf und die undurchlässige Folie schützt den Boden.

**Verbesserte Qualität.**

Cod.	m	-	EAN	N° x	x	x	€ m <sup>2</sup>	€ m	€	€
1A110474	1.00x10		8002929100115	12	10	-	-	-	8,26	99,12
1A100497	1.00x25		8002929094940	1	-	46	0,70	0,70	-	17,50
1A110431	1.00x50		8002929099792	1	-	23	0,69	0,69	-	34,50

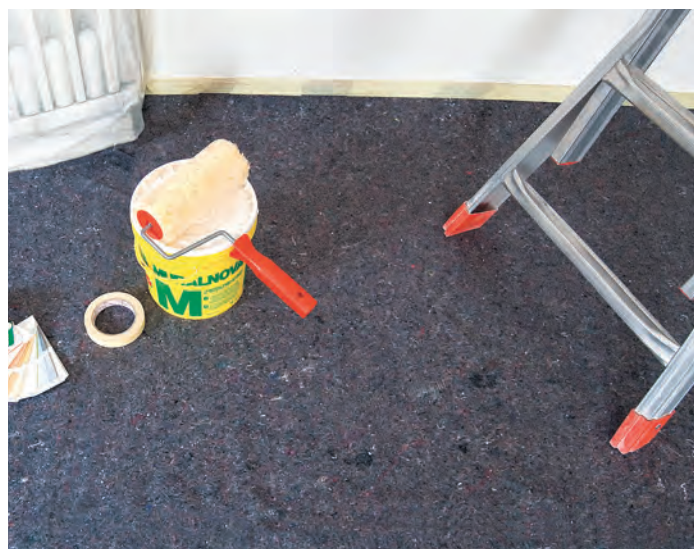





## Zanzariere

Per proteggere da zanzare, mosche, ragni ed insetti, tre reti in materiali e colori diversi: in fibra di vetro, ideale per le finestre delle abitazioni; in alluminio, resistente ed adatta anche a schermare piccole aperture in casa, in cortile o in giardino; in plastica, multiuso e versatile, abbina estetica e convenienza.

## Mosquito nets

To protect against mosquitoes, flies, spiders and insects, three nets in different materials and colours: in fibreglass, ideal for house windows; in aluminium, resistant and also suitable to screen small openings at home, in courtyards or gardens; in plastic, multiuse and versatile, they combine aesthetics and convenience.

## Moustiquaires

Pour se protéger des moustiques, des mouches, des araignées et d'autres insectes, trois filets de couleurs et matériaux différents. En fibre de verre: parfait pour les fenêtres des habitations; en aluminium: résistant et adapté pour occulter les petits endroits ouverts dans la maison, dans la cour ou dans le jardin; en plastique: multi-usages et polyvalent, ils allient esthétique et confort.

## Mosquiteras

Para proteger de mosquitos, moscas, arañas y pequeños insectos, mallas de materiales y colores diferentes: en fibra de vidrio, ideal para las ventanas de las viviendas; en aluminio, resistente y adaptada incluso para ocultar y proteger también pequeñas aperturas en terrazas, patios o jardines; en plástico, multiusos e ideal para proteger y filtrar.

## Mückennetze

Zum Schutz gegen Mücken, Fliegen, Spinnen und Insekten. Drei Netze aus verschiedenen Materialien und Farben: aus Glasfaser, ideal für Hausfenster; aus Aluminium, beständig und zum Abschirmen kleiner Öffnungen im Haus, in Höfen oder Gärten; aus Kunststoff, mehrfach anwendbar und vielseitig kombinieren sie Ästhetik und Komfort.

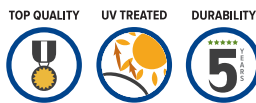

# TROPICAL

# 5

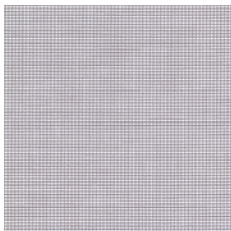

1.6x1.6 mm



### In fibra di vetro.

Leggera e flessibile, si adatta a qualsiasi struttura, con il minimo impatto visivo. Si taglia senza che si sfilacci.

### In fibreglass.

Lightweight, it can be cut with scissors (it does not unravel) to fit to any structure. As it is washable, it can be stored away at the end of the season.

### En fibre de verre.

Légère, elle s'adapte à toutes structures avec un minimum d'impact visuel. Elle peut être coupée avec des ciseaux et ne s'effiloche pas.

### De fibra de vidrio.

Muy ligera y flexible, puede cortarse con tijeras sin deshilarse y se adapta a cualquier estructura.

### In Glasfaser.

Leichtgewichtig und kann mit der Schere (franzt nicht aus) auf jede Form zugeschnitten werden.

Cod.	m	-	EAN	N° x	x	x	€ m <sup>2</sup>	€ m	€	€
73310812	0.80x5	■	8002929039002	9	20	-	-	-	14,15	127,35
73310712	1.00x5	■	8002929039019	9	20	-	-	-	15,43	138,87
73310912	1.20x5	■	8002929000620	9	20	-	-	-	17,15	154,35
73310112	0.80x30	■	8002929039569	4	20	-	-	-	53,94	215,76
1A030150	1.00x30	■	8002929063328	4	20	-	-	-	67,42	269,68
73310212	1.00x30	■	8002929039583	4	20	-	-	-	67,42	269,68
73310211	1.00x30	□	8002929039644	4	20	-	-	-	70,85	283,40
73310312	1.20x30	■	8002929039620	4	20	-	-	-	80,91	323,64
73310311	1.20x30	□	8002929039637	4	20	-	-	-	85,02	340,08
73010402	1.40x30	■	8002929054760	4	20	-	-	-	94,38	377,52
73010401	1.40x30	□	8002929054777	4	20	-	-	-	99,20	396,80

# 5 MOSQUITO

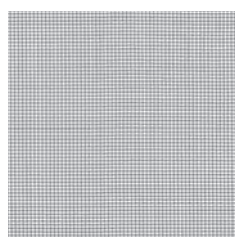

1.6x1.6 mm

**In plastica.**

A disegno regolare, non si smaglia né si deforma, si sagoma facilmente e si adatta a qualsiasi struttura. Ottimo rapporto qualità/prezzo.

**In plastic.**

Extruded plastic square mesh, it does not ladder or deform and it is easy to shape and adapt to any structure. Low visual impact and cost-effective.

**En plastique.**

Maille rectangulaire au dessin régulier qui ne s'effiloche pas et ne se déforme pas. Facile à poser, elle s'adapte à toutes les structures. Attractive et peu coûteuse, elle a un excellent rapport qualité/prix.

**De plástico.**

Con un diseño regular, no se deforma ni se deshilacha y se adapta a cualquier tipo de estructura. Decorativa y económica, tiene una excelente relación calidad/precio.

**In Kunststoff.**

Extrudiertes Gitter aus Kunststoff, formstabil und weiterreißfest, einfach zuzuschneiden und an jede Struktur anzupassen. Geringe visuelle Beeinträchtigung und kostengünstig.

Cod.	m	-	EAN	N° x	x	x	€ m²	€ m	€	€	
72010106	1.00x5		8002929032317	6	24	-	-	-	13,50	81,00	
72010108	1.00x5		8002929012814	6	24	-	-	-	13,50	81,00	
1A040403	1.00x50		8002929069634	-	-	20	1,63	1,63	-	81,50	
1A040399	1.00x50		8002929069597	-	-	20	1,63	1,63	-	81,50	
1A040401	1.00x50		8002929069610	-	-	20	1,63	1,63	-	81,50	

# 5

# ZANZIBAR

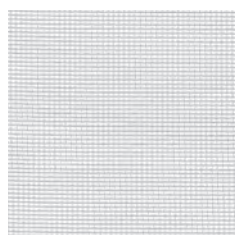

1.8x1.4 mm

**In alluminio.**

Maggiormente rigida e molto resistente allo strappo, può essere sagomata e adattata ad ogni struttura, anche per uso agricolo o di allevamento.

**In aluminium.**

Highly resistant and rigid, it can be shaped and adapted to any structure, also for agriculture and animal breeding.

**En aluminium.**

Rigide et très résistante, traitée contre la rouille, elle peut être formée et adaptée à toutes les structures et également utilisée pour l'agriculture ou l'élevage.

**De aluminio.**

Muy rígida y altamente resistente a la rotura, se puede cortar y adaptar a cualquier tipo de estructura; también para aplicaciones agrícolas y ganaderas.

**In Aluminium.**

Sehr widerstandsfähig und stabil, kann es geformt und an jede Struktur angepasst werden, auch für die Landwirtschaft und Tierzucht.

Cod.	m	-	EAN	N° x	x	x	€ m²	€ m	€	€	
1A130283	1.00x5		8002929109637	12	32	-	-	-	19,25	231,00	
73011122	0.80x30		8002929048691	-	64	-	2,94	2,35	-	70,56	
73011221	1.00x30		8002929044204	-	64	-	2,91	2,91	-	87,30	
73011321	1.20x30		8002929048707	-	64	-	2,93	3,52	-	105,48	



**LINEA PET**

Una nuova linea dedicata agli amici animali, una serie di **soluzioni** per proteggere i tuoi animali e il tuo giardino. Le reti protettive **Pet&Garden** sono **Made in Italy**, realizzate con polimeri vergini, atossiche, metal free e sono state approvate da professionisti del settore.

**PET LINE**

A new line dedicated to our animal friends. A series of **solutions** to protect your animals and your garden. The **Pet&Garden** protective meshes are **Made in Italy** from virgin, non-toxic and metal free polymers and have been approved by industry professionals.

**LIGNE ANIMAUX**

Une nouvelle gamme de produits dédiée à vos amis les animaux, une série de **solutions** permettant de protéger vos animaux ainsi que votre jardin. Les filets de protection **Pet&Garden** sont **Made in Italy**. Ils sont réalisés avec des polymères vierges, non toxiques et sans métaux lourds.

**LINEA PET**

Una nueva línea dedicada a los animales domésticos. Una serie de **soluciones** para proteger a los animales y al jardín. Las mallas de protección **TENAX Pet** son **Made in Italy**, realizadas con polímeros vírgenes, atóxicas, libres de metales pesados y están aprobadas por profesionales del sector.

**HAUSTIERREIHE**

Eine neue Linie für unsere Tierfreunde entwickelt. Eine Reihe an **Lösungen** um Ihre Tiere und Ihren Garten zu schützen. Die **Haustier&Garten** Schutznetze sind **Made in Italy** aus reinen, ungiftigen und metallfreien Polymeren und wurden von Fachleuten genehmigt.

# ITALY FLORET



**Protegge le aiuole e ti aiuta ad educare il cane.**

Bordura decorativa rinforzata in plastica. Delimita le aiuole e gli angoli fioriti del giardino e ti aiuta nell'educazione del cane impedendo l'accesso solo all'area circoscritta.

**Protects flowerbeds and helps you train your dog.**

Reinforced plastic decorative edging. Outlines flowerbeds and flowering corners of the garden and helps you train your dog by allowing access only to the surrounded area.

**Protège les parterres et aide à éduquer votre chien.**

Bordure décorative renforcée en plastique. Délimite les plates-bandes et les coins fleuris. Elle aide à l'éducation du chien en empêchant l'accès à la zone circonscrite.

**Protege los parterres y ayuda a educar al perro.**

Bordura decorativa plástica reforzada. Delimita los parterres y las zonas con plantas de flor y ayuda a educar al perro impidiendo el acceso a la zona delimitada.

**Schützt Ihr Blumenbeet und hilft Ihnen Ihren Hund zu trainieren.**

Aus Kunststoff mit dekorativen Verstärkungsstreifen. Umrahmt Blumenbeete und Blumenecken des Gartens und hilft Ihnen Ihren Hund zu trainieren, indem nur die eingezäunten Bereiche zugänglich sind.

Cod.	m	-	EAN	N° x	x	x	€ m <sup>2</sup>	€ m	€	€
1A120328	0.40x5	■	8002929104557	12	14	-	-	-	10,38	124,56
1A120329	0.60x5	■	8002929104564	12	7	-	-	-	15,01	180,12

# ITALY BERMUDA

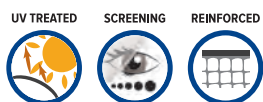

720 g/m<sup>2</sup>



**Schermata ed evita lo stress al tuo cane.**

Schermatura totale da applicare su una struttura di sostegno (il TNT va installato a contatto con la recinzione). Evita al tuo cane stress ed agitazione dovuti al passaggio di auto, pedoni e altri animali in strada o nei giardini confinanti, limitando la quantità di stimoli a cui viene esposto. Inoltre, la rete di rinforzo in plastica rigida, impedisce al cane di fuggire attraverso cancelli, recinzioni o balconi.

**Screen to prevent your dog from stressing.**

Total screening to apply on a support structure (the TNT should be installed in contact with the fence). Prevents stress and agitation caused to your dog by passing cars, pedestrians and other animals in the neighbours' gardens. Moreover, the reinforcing rigid plastic mesh prevents the dog from escaping through gates, fences or balconies.

**Oculte et évite le stress à votre chien.**

Occultation totale à appliquer sur une structure de soutien (le tissu non tissé doit être installé en contact avec la clôture). Elle évite à votre chien stress et agitation provoqués par le passage d'autos, de piétons et d'autres animaux se trouvant dans les jardins limitrophes, en limitant la quantité de stimulations auxquels il est exposé. Le filet en plastique rigide empêche en outre le chien de fuir au travers des portails, clôtures ou balcons.

**Oculta y evita que el perro se estrese.**

Ocultación total obtenida por la combinación de una malla rígida y un tejido-no-tejido. Colocada en un cercado (el TNT se instala en contacto con la cerca), evita que el perro se ponga nervioso con el paso de vehiculos, de peatones y de otros animales. Además, la malla de refuerzo de plástico rígido, impide que el perro se escape a través de las vallas, cercados o balcones.

**Sichtschutz um Ihren Hund vor Stress zu schützen.**

Der 100%ige Sichtschutz wird auf einer Trägerstruktur angebracht (das Vlies sollte im Kontakt mit dem Zaun eingebaut werden). Verhindert, dass Ihr Hund durch vorbeifahrende Autos, Fußgänger und andere Tiere in den Nachbargärten gestört und gestresst wird. Darüber hinaus verhindert das feste Kunststoffgitter, dass der Hund durch Tore, Zäune oder Balkone entkommt.

Cod.	m	-	EAN	N° x	x	x	€ m <sup>2</sup>	€ m	€	€
1A150067	1.00x3	■	8002929115157	6	14	-	-	-	24,11	144,66
1A150063	1.50x5	■	8002929115119	2	12	-	-	-	60,29	120,58





TOP QUALITY



MAX LOAD  
20 t



WEIGHT  
640 g/m<sup>2</sup>



THICKNESS  
5 mm



35x33 mm



**Protegge il prato senza far male al tuo cane.**

Rete in plastica a maglia romboidale. Stesa sul manto erboso, rinforza il prato, lo rende carrabile ed impedisce al cane di scavare buche in giardino. Posizionata in prossimità delle recinzioni, impedisce al cane di fuggire passando al di sotto della delimitazione.

**Protects the lawn without harming your dog.**

Plastic, diamond mesh net. Laid on the turf, it reinforces the lawn, making it suitable for vehicles and preventing the dog from digging holes in the garden. Positioned near the fences, it prevents the dog from escaping by passing under the delimitation.

**Protège le gazon sans blesser votre chien.**

Filet en plastique à maille rhomboïdale. Étendu sur le gazon, il renforce la pelouse, le rend accessible aux véhicules et empêche votre chien de creuser des trous dans le jardin. Placé près des barrières, il empêche le chien de s'échapper, en passant au-dessous de la clôture.

**Protege el césped sin hacer daño a tu mascota.**

Malla plástica romboidal, ligera y flexible, que garantiza una elevada protección del césped. Ideal para zonas de paso de vehículos y para evitar que los perros escarben en el terreno dañando el césped. Colocada por debajo de los cercados, impide que el perro escape.

**Schützt den Rasen ohne Ihrem Hund zu schaden.**

Kunststoffgitter mit diamantförmigen Maschen. Auf den Rasen gelegt, verstärkt es den Rasen, macht ihn befahrbar für Fahrzeuge und verhindert, dass Hunde Löcher in den Garten graben. In der Nähe der Zäune aufgestellt, verhindert es, dass der Hund unter der Abgrenzung entweicht.



VIDEO TUTORIAL

Cod.	m	-	EAN	N° x	x	x	€ m <sup>2</sup>	€ m	€	€
1A130210	1.00x5		8002929109040	4	9	-	-	-	21,00	84,00



**Accessori Accessories Accessoires Accesorios Zubehör**

Cod.	m	-	EAN	N° x	x	x	€ m <sup>2</sup>	€ m	€	€
------	---	---	-----	------	---	---	------------------	-----	---	---

**CHIODI A U SPECIAL per TR – U STAPLES SPECIAL for TR – AGRAFES U SPECIALES pour TR – CLAVOS EN U ESPECIAL para TR – U-KLAMMERN SPEZIAL für TR**

STRONG



Ø 5 mm  
10 x 22 cm

10 pcs	1A150128	0.22		8002929115744	12	-	-	-	6,12	73,44
	1B100084	0.22		8002929012401	200	-	-	-	0,43	86,00

# HOBBY 10

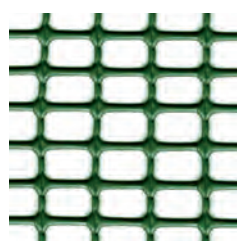

15x10 mm

**Evita fughe indesiderate.**

Rete in plastica a maglia rettangolare, atossica e resistente. Si installa su recinzioni e cancellate come protezione aggiuntiva per impedire la fuga di cani e altri animali domestici. Posizionata sul balcone, impedisce al cane di sporgersi o di far cadere giochi ed oggetti.

**Prevents unwanted escape.**

A rectangular mesh net, non-toxic and durable. It can be installed on fences and gates as additional security to prevent dogs and other pets from escaping. Placed on the balcony, it prevents the dog from leaning out or letting toys and objects fall.

**Empêcher les fugues de votre chien.**

Filet en plastique à maille rectangulaire, atoxique et résistant. Il s'installe sur les clôtures et les portails comme protection supplémentaire afin d'empêcher la fugue des chiens et d'autres animaux domestiques. Positionné sur le balcon, il empêche les chiens de se pencher ou de faire tomber des jeux ou des objets.

**Evita que los perros se escapen.**

Malla plástica rectangular, atóxica y especialmente resistente. Se instala fácilmente como protección adicional en vallas y barandillas para impedir que los perros y los pequeños animales domésticos se escapen. Colocada en el balcón, impide que el perro se asome o tire juegos u objetos.

**Verhindert unerwünschtes Ausbrechen.**

Ein Gitter mit rechteckiger Masche, ungiftig und langlebig. Es kann an Zäune und Toren als zusätzliche Sicherheit eingebaut werden, um zu verhindern, dass Hunde und andere Haustiere ausreißen. Auf dem Balkon verhindert es, dass der Hund sich hinauslehnt oder Spielzeuge und Gegenstände herunterfallen.

Cod.	m	-	EAN	N° x	x	x	€ m <sup>2</sup>	€ m	€	€
------	---	---	-----	------	---	---	------------------	-----	---	---

1A150065	1.00x5		8002929115133	6		24	-	-	13,52	81,12
----------	--------	--	---------------	---	--	----	---	---	-------	-------

# RANCH

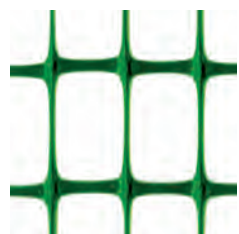

30x45 mm

**Delimita lo spazio dedicato al tuo cane.**

Rete in plastica ad altissima resistenza e di lunga durata ideale per recinzioni permanenti. Delimita le aree dedicate ai cani di taglia medio-piccola tenendoli lontani da zone potenzialmente pericolose come rampe d'accesso ai garage o dedicate alla manovra delle automobili. La rete Ranch non necessita di recinzione o cancellata di supporto.

**Delimits the space dedicated to your dog.**

Very durable and strong plastic mesh ideal for permanent fencing. It delimitates the areas dedicated to small-medium sized dogs, keeping them away from potentially dangerous areas such as garage access ramps or areas dedicated to manoeuvring cars. The Ranch mesh does not need to be supported by fencing or railings.

**Délimite l'espace dédié à votre chien.**

Filet en plastique de grande résistance et de longue durée, idéal pour les clôtures permanentes. Il délimite les zones dédiées aux chiens de moyenne et petite taille en les maintenant éloignés des zones dangereuses telles que rampe d'accès aux garages ou zones dédiées aux manœuvres des automobiles. Le filet Ranch ne nécessite d'aucune clôture ou de portail.

**Delimita el espacio dedicado al perro.**

Malla plástica de alta resistencia y larga durabilidad, ideal para cercados permanentes. Delimita las zonas dedicadas a los perros de talla medio-pequeña, alejándolos de zonas peligrosas como rampas de acceso a garajes o zonas dedicadas a la maniobra de automóviles. La malla Ranch no necesita valla de apoyo.

**Grenzt den Raum für Ihren Hund ab.**

Sehr robustes und starkes Gitter aus Kunststoff, ideal für die dauerhafte Umzäunung. Es grenzt die Bereiche für kleine bis mittelgroße Hunde ab, hält sie fern von potenziell gefährlichen Bereichen wie Garagenzugängen oder Bereichen, in denen Autos verkehren. Das Ranch Gitter muss nicht durch Zäune oder Geländer gestützt werden.

Cod.	m	-	EAN	N° x	x	x	€ m <sup>2</sup>	€ m	€	€
------	---	---	-----	------	---	---	------------------	-----	---	---

1A130305	1.00x10		8002929109859	6		24	-	-	18,25	109,50
1A130306	1.50x10		8002929109866	6		12	-	-	27,49	164,94



## ACCESSORI

Accessori per Garden e FAI DA TE: fascette, corde, legature, anelli, fili metallici, pali di sostegno, chiodi, clips e strumenti di misurazione.

## ACCESSORIES

Accessories for the garden and DIY: ties, ropes, rings, wire, support posts, nails, clips and measuring instruments.

## ACCESSOIRES

Accessoires pour le jardin et le bricolage: liens, cordes, ficelles, anneaux, fils métalliques, piquets de soutien, agrafes U, clips et outils de mesure.

## ACCESORIOS

Accesorios para jardinería y bricolaje: Bridas, cuerdas, fleje, anillos, hilo metálico, postes, clavos, clips e instrumentos de medición.

## ZUBEHÖR

Zubehör für den Garten und den Heimwerker: Befestigungen, Seile, Drähte, Pfosten, Nägel, Klammern und Messgeräte.

Cod.	m	-	EAN	N° x	x	x	€ m <sup>2</sup>	€ m	€	€
------	---	---	-----	------	---	---	------------------	-----	---	---



Fascette multiuso 10 cm – 10 cm multipurpose plastic ties – Liens multi-usages en plastique 10 cm – Bridas de plástico multiuso 10 cm – Mehrzweck-Kabelbinder 10 cm  
 Confezione da **50 pezzi** – Pack of **50 pieces** – Sachet de **50 pièces** – Envasado en bolsas de **50 unidades** – Packung mit **50 Stk.**



L 100 x 2.5 mm



30010209	0.10		8002929000514	20	175	-	-	-	1,63	32,60
1A070506	0.10		8002929082558	20	175	-	-	-	1,63	32,60
1A030244	0.10		8002929064448	20	175	-	-	-	1,63	32,60
1A030245	0.10		8002929064431	20	175	-	-	-	1,63	32,60
1A100275	0.10		8002929093295	20	175	-	-	-	1,63	32,60



Fascette multiuso 14 cm – 14 cm multipurpose plastic ties – Liens multi-usages en plastique 14 cm – Bridas de plástico multiuso 14 cm – Mehrzweck-Kabelbinder 14 cm  
 Confezione da **50 pezzi** – Pack of **50 pieces** – Sachet de **50 pièces** – Envasado en bolsas de **50 unidades** – Packung mit **50 Stk.**



L 140 x 3.6 mm



1A170289	0.14		8002929123916	20	77	-	-	-	2,09	41,80
1A170290	0.14		8002929123923	20	77	-	-	-	2,09	41,80



Fascette multiuso 20 cm – 20 cm multipurpose plastic ties – Liens multi-usages en plastique 20 cm – Bridas de plástico multiuso 20 cm – Mehrzweck-Kabelbinder 20 cm  
 Confezione da **50 pezzi** – Pack of **50 pieces** – Sachet de **50 pièces** – Envasado en bolsas de **50 unidades** – Packung mit **50 Stk.**



L 200 x 4.8 mm



30010201	0.20		8002929000521	20	77	-	-	-	3,27	65,40
1A120234	0.20		8002929000521	100 Promobox	20	-	-	-	3,27	327,00
1A100279	0.20		8002929093318	20	77	-	-	-	3,27	65,40
1A100281	0.20		8002929093325	20	77	-	-	-	3,27	65,40
1A100277	0.20		8002929093301	20	77	-	-	-	3,27	65,40
1A070218	0.20		8002929080080	20	77	-	-	-	3,27	65,40
1A150487	0.20		8002929118462	20	77	-	-	-	3,27	65,40



Cod.	m	-	EAN	N° x	x	x	€ m <sup>2</sup>	€ m	€	€
------	---	---	-----	------	---	---	------------------	-----	---	---

TOP QUALITY UV TREATED STRONG DURABILITY



Fascette multiuso 29 cm – 29 cm multipurpose plastic ties – Liens multi-usages en plastique 29 cm – Bridas de plástico multiuso 29 cm – Mehrzweck-Kabelbinder 29 cm  
 Confezione da **50 pezzi** – Pack of **50 pieces** – Sachet de **50 pièces** – Envasado en bolsas de **50 unidades** – Packung mit **50 Stk.**



L 290 x 4.8 mm

1A140287	0.29		8002929113382	20	48	-	-	-	4,28	85,60
1A150316	0.29		8002929117229	20	48	-	-	-	4,28	85,60
1A150318	0.29		8002929117236	20	48	-	-	-	4,28	85,60
<b>NEW</b> 1A180308	0.29		8002929126221	20	48	-	-	-	4,28	85,60
1A150314	0.29		8002929117212	20	48	-	-	-	4,28	85,60

TOP QUALITY UV TREATED STRONG DURABILITY OPEN - CLOSE



Fascette apri e chiudi 20 cm – 20 cm multipurpose open-close plastic ties – Liens réutilisables 20 cm – Bridas multiuso 20 cm – Wiederverschließbare Kabelbinder 20 cm  
 Confezione da **20 pezzi** – Pack of **20 pieces** – Sachet de **20 pièces** – Envasado en bolsas de **20 unidades** – Packung mit **20 Stk.**



1A170294	0.20		8002929123961	20	77	-	-	-	3,59	71,80
----------	------	--	---------------	----	----	---	---	---	------	-------



VIDEO TUTORIAL

## FASCETTE PER CANNICCI – CANE SCREEN TIES – LIENS POUR CANNISSES – BRIDAS CAÑIZO – SCHILFROHR-BEFESTIGUNGEN

Confezione da **26 pezzi** – Pack of **26 pieces** – Sachet de **26 pièces** – Envasado en bolsas de **26 unidades** – Packung mit **26 Stk.**



1A150506	0.15		8002929104878	25	-	-	-	-	3,26	81,50
1A150507	0.15		8002929104861	25	-	-	-	-	3,26	81,50

Anche a pagina – Also at page – Voir page – También en la página – Auch auf der Seite **72**

## FASCETTE APRI-CHIUDI – ADJUSTABLE PLANT TIES – LIENS POUR PLANTES RÉGLABLES – BRIDAS MULTIUSO – VERSTELLBARE PFLANZEN-VERBINDUNGEN

Confezione da **50 pezzi** – Pack of **50 pieces** – Sachet de **50 pièces** – Envasado en bolsas de **50 unidades** – Packung mit **50 Stk.**



99420100	0.125		5010453824004	12	-	-	-	-	2,48	29,76
----------	-------	--	---------------	----	---	---	---	---	------	-------

Cod.	m	-	EAN	N° x	x	x	€ m <sup>2</sup>	€ m	€	€
------	---	---	-----	------	---	---	------------------	-----	---	---

UV TREATED



## CLIPS RETE – CLIPS – CLIPS – CLIPS MALLA – KLAMMERN



### CLIPS 35

24 pcs	99161000	3.5 cm		8002929000569	10	77	-	-	-	4,13	41,30
	99160600	3.5 cm		8002929024022	500	40	-	-	-	0,12	60,00

### CLIPS 50

12 pcs	1A030240	5 cm		8002929064400	12	77	-	-	-	2,70	32,40
12 pcs	1A140415	5 cm		8002929114563	12	77	-	-	-	2,70	32,40
	99168000	5 cm		8002929054999	500	-	-	-	-	0,14	70,00
	1A160215	5 cm		8002929120465	500	-	-	-	-	0,14	70,00

### CLIPS 100

	99165099	8 cm		8002929024121	500	25	-	-	-	0,37	185,00
--	----------	------	--	---------------	-----	----	---	---	---	------	--------

Anche a pagina – Also at page – Voir page – También en la página – Auch auf der Seite **54**

## FISSARETE per TexStyle – ELASTIC TIE for TexStyle – CORDON ÉLASTIQUE pour TexStyle – FIJADORA para TexStyle – ZAUNBEFESTIGUNG für TexStyle

Per schermature con occhielli – Ideal for screening nets with eyelets – Idéal pour filets avec oeillets – Ideal para mallas de ocultación con ojales – Ideal für Sichtschutznetze mit Ösen  
Confezione da **10 pezzi** – Pack of **10 pieces** – Sachet de **10 pièces** – Envasado en bolsas de **10 unidades** – Packung mit **10 Stk.**



	1A140306	15 cm		8002929113597	20	-	-	-	-	2,50	50,00
--	----------	-------	--	---------------	----	---	---	---	---	------	-------

Anche a pagina – Also at page – Voir page – También en la página – Auch auf der Seite **43**

## CLIPS DI FISSAGGIO per Corolla – FIXING CLIPS for Corolla – CLIPS DE FIXATION pour Corolla – CLIPS DE FIJACION para Corolla – BEFESTIGUNGS-SET für Corolla

Confezione da **6 pezzi** – Pack of **6 pieces** – Sachet de **6 pièces** – Envasado en bolsas de **6 unidades** – Packung mit **6 Stk.**



	3A021852	3.5 cm		5010453852007	12	-	-	-	-	2,90	34,80
--	----------	--------	--	---------------	----	---	---	---	---	------	-------

Anche a pagina – Also at page – Voir page – También en la página – Auch auf der Seite **117**

Cod.	m	-	EAN	N° x	x	x	€ m <sup>2</sup>	€ m	€	€
------	---	---	-----	------	---	---	------------------	-----	---	---

## PALO A "T" EXTRA – EXTRA T POST – PIQUET CLASSIQUE EN "T" – POSTE EN FORMA DE T – DER KLASSISCHE "T"-PFOSTEN



1A090019	1.00		8002929087010	10	-	-	-	-	4,72	47,20
1A090020	1.25		8002929087027	10	-	-	-	-	5,71	57,10
1A160338	1.25		8002929121431	10	-	-	-	-	6,16	61,60
1A090021	1.50		8002929087034	10	-	-	-	-	6,74	67,40
1A160337	1.50		8002929121424	10	-	-	-	-	7,27	72,70
1A090022	1.75		8002929087041	10	-	-	-	-	7,75	77,50
1A160336	1.75		8002929121417	10	-	-	-	-	8,36	83,60
1A090023	2.00		8002929087058	10	-	-	-	-	9,11	91,10
1A160335	2.00		8002929121400	10	-	-	-	-	10,27	102,70
1A160288	2.50		8002929120991	10	-	-	-	-	16,25	162,50

Pezzo etichettato singolarmente – Piece individually labelled – Pièce étiquetée individuellement – Pieza etiquetada individualmente – Jedes Stück einzeln belabelt

## SAETTA EXTRA – EXTRA ARROW – POTEAU DE RENFORT – POSTE DE APOYO – VERSTÄRKUNGSPFOSTEN



1A090024	1.20		8002929087065	10	-	-	-	-	6,30	63,00
1A160348	1.20		8002929121509	10	-	-	-	-	6,79	67,90
1A090025	1.50		8002929087072	10	-	-	-	-	7,95	79,50
1A160349	1.50		8002929121516	10	-	-	-	-	8,57	85,70
1A160294	2.00		8002929121035	10	-	-	-	-	12,75	127,50

Pezzo etichettato singolarmente – Piece individually labelled – Pièce étiquetée individuellement – Pieza etiquetada individualmente – Jedes Stück einzeln belabelt

## TENDIFILO METALLICO – WIRE TENSIONER – TENDEUR DE FIL – TENSOR METALICO DE HILOS – DRAHTSPANNER



1A090090	0.10		8002929087614	50	-	-	-	-	1,01	50,50
----------	------	--	---------------	----	---	---	---	---	------	-------

Cod.	m	-	EAN	N° x	x	x	€ m <sup>2</sup>	€ m	€	€
------	---	---	-----	------	---	---	------------------	-----	---	---

## FILO PLASTIFICATO EXTRA – EXTRA WIRE – FIL MÉTALLIQUE PLASTIFIÉ EXTRA LOURD – ALAMBRE METÁLICO PLASTIFICADO EXTRA-GRUESO – KUNSTSTOFFBESCHICHTETER DRAHT



ø 2 mm	1A090086	100.00		8002929087584	10	48	-	-	-	7,58	75,80
ø 3,1 mm	1A090087	100.00		8002929087591	5	48	-	-	-	15,38	76,90

## FILI METALLICI – METAL WIRES – FIL MÉTALLIQUE – HILOS METÁLICOS – METALLDRAHT



### PLASTIFICATO LEGGERO – PLASTIC-COATED LIGHT – PLASTIFIÉ (LÉGER) – PLASTIFICADO LIGERO – DÜNNER KUNSTSTOFF-BESCHICHTETER

ø 1 mm	99470300	50.00		5010453838001	12	150	-	-	-	3,17	38,04
--------	----------	-------	--	---------------	----	-----	---	---	---	------	-------



### PLASTIFICATO PESANTE – PLASTIC-COATED HEAVY – PLASTIFIÉ (LOURD) – PLASTIFICADO GRUESO – DICKER KUNSTSTOFF-BESCHICHTETER

ø 2 mm	1A160064	15.00		8002929119315	12	-	-	-	-	1,59	19,08
ø 2 mm	99470200	30.00		5010453835000	12	120	-	-	-	2,81	33,72

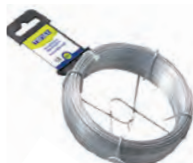

### GALVANIZZATO LEGGERO – GALVANIZED LIGHT – GALVANISÉ (LÉGER) – GALVANIZADO LIGERO – DÜNNER VERZINKTER

ø 1 mm	3A032035	80.00		5010453320353	12	-	-	-	-	3,24	38,88
--------	----------	-------	--	---------------	----	---	---	---	---	------	-------



### GALVANIZZATO PESANTE – GALVANIZED HEAVY – GALVANISÉ (LOURD) – GALVANIZADO GRUESO – DICKER VERZINKTER

ø 2 mm	3A032040	20.00		5010453320407	12	-	-	-	-	4,16	49,92
--------	----------	-------	--	---------------	----	---	---	---	---	------	-------

## PALETTO PLASTIFICATO – PLAST POST – PIQUET EN FER PLASTIFIÉ – POSTE DE HIERRO – KUNSTSTOFFBESCHICHTETER EISENPFOSTEN



ø 16 mm

<b>NEW</b>	1A180307	0.75		8002929126214	6	-	-	-	-	2,85	17,10
	3A021377	1.00		5010453377005	6	-	-	-	-	3,51	21,06
<b>NEW</b>	1A180301	1.25		8002929126177	6	-	-	-	-	4,25	25,50
	3A021378	1.50		5010453378002	6	-	-	-	-	4,98	29,88
<b>NEW</b>	1A180350	1.80		8002929126498	6	-	-	-	-	6,20	37,20

Pezzo etichettato singolarmente – Piece individually labelled – Pièce étiquetée individuellement – Pieza etiquetada individualmente – Jedes Stück einzeln belabelt



Cod.	m	-	EAN	N° x	x	x	€ m <sup>2</sup>	€ m	€	€
------	---	---	-----	------	---	---	------------------	-----	---	---

## MAT STRIPE

Nastro di giunzione in tessuto non tessuto (da utilizzare con colla) – Connecting non-woven tape (using glue) – Ruban de jointement (à l'aide d'une colle) – Banda de unión (mediante el uso de cola) – Band aus Vliesstoff mit Klebstoff zu verwenden



1A100491	0.23x20		8002929094889	4	48	-	-	-	11,55	46,20
----------	---------	--	---------------	---	----	---	---	---	-------	-------

Anche a pagina – Also at page – Voir page – También en la página – Auch auf der Seite **80**

## MAT SEAL

Nastro di giunzione monoadesivo – Single-sided adhesive connecting tape – Ruban mono-adhésif de jointure – Cinta de unión monoadesiva – Einzelklebverbindungsband



1A140240	0.15x10		8002929110046	4	-	-	-	-	52,50	210,00
----------	---------	--	---------------	---	---	---	---	---	-------	--------

Anche a pagina – Also at page – Voir page – También en la página – Auch auf der Seite **80**

## MAT DUO

Nastro biadesivo bituminoso – Bi-adhesive bituminous tape – Ruban bi-adhésif bitumeux – Cinta biadhesiva bituminosa – Bituminös doppelseitiges Klebeband



1A130323	0.05x10		8002929110053	4	-	-	-	-	32,05	128,20
----------	---------	--	---------------	---	---	---	---	---	-------	--------

Anche a pagina – Also at page – Voir page – También en la página – Auch auf der Seite **80**

## PICCHETTO – PICKET – PIQUET – PIQUETE – ERDSPIESS

In ferro verniciato – Made of black painted iron – En fer peint de couleur noir – En hierro barnizado de color negro – Hergestellt aus schwarz lackiertem Eisen



34926001	0.60		8002929040435	-	-	-	-	-	-	4,82
----------	------	--	---------------	---	---	---	---	---	---	------

Anche a pagina – Also at page – Voir page – También en la página – Auch auf der Seite **26**

## PIEDINO PIATTO – FLAT FOOT – PLAQUE DE PIED – PIE PLANO – FUSS

In ferro verniciato – Made of black painted iron – En fer peint de couleur noir – En hierro barnizado de color negro – Hergestellt aus schwarz lackiertem Eisen



34940100	0.17x0.48		8002929039668	-	-	-	-	-	-	7,64
----------	-----------	--	---------------	---	---	---	---	---	---	------

Anche a pagina – Also at page – Voir page – También en la página – Auch auf der Seite **26**

Cod.	m	-	EAN	N° x	x	x	€ m <sup>2</sup>	€ m	€	€
------	---	---	-----	------	---	---	------------------	-----	---	---

## CHIODI METALLICI A TESTA PIANA – FLAT-HEAD METAL NAILS – CLOUS MÉTALLIQUE À TÊTE PLATE – CLAVOS METÁLICOS DE CABEZA PLANA – METALLISCHE NÄGEL MIT FLACHKOPF



18 cm

1A120504	0.18	■	8002929106018	140	-	-	-	-	0,26	36,40
----------	------	---	---------------	-----	---	---	---	---	------	-------

Anche a pagina – Also at page – Voir page – También en la página – Auch auf der Seite **80**

## CHIODI METALLICI PROFESSIONALI per Cover PRO-HG – PROFESSIONAL METAL STAPLES for Cover PRO-HG – AGRAFES MÉTALLIQUES PROFESSIONNELLES pour Cover PRO-HG – CLAVOS METÁLICOS PROFESIONALES para Cover PRO-HG – PROFI METALLKLAMMERN für Cover PRO-HG



Confezione da 20 pezzi – Pack of 20 pieces – Sachet de 20 pièces – Envasado en bolsas de 20 unidades – Packung mit 20 Stk.



25 x 20 cm

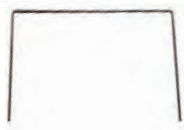

1A160218	0.25	■	8002929120496	20	33	-	-	-	6,57	131,40
----------	------	---	---------------	----	----	---	---	---	------	--------

Anche a pagina – Also at page – Voir page – También en la página – Auch auf der Seite **99**

## CHIODI A U SPECIAL per TR – U STAPLES SPECIAL for TR – AGRAFES U SPECIALES pour TR – CLAVOS EN U ESPECIAL para TR – U-KLAMMERN SPEZIAL für TR



10 x 22 cm

10 pcs

1A150128	0.22	■	8002929115744	12	-	-	-	-	6,12	73,44
1B100084	0.22	■	8002929012401	200	-	-	-	-	0,43	86,00

Anche a pagina – Also at page – Voir page – También en la página – Auch auf der Seite **81**

## CHIODI A U GP FLEX – U STAPLES GP FLEX – AGRAFES U GP FLEX – CLAVOS EN U GP FLEX – U-KLAMMERN GP FLEX



6 x 30 cm

1A050176	0.30	■	8002929072016	100	33	-	-	-	1,29	129,00
----------	------	---	---------------	-----	----	---	---	---	------	--------

Anche a pagina – Also at page – Voir page – También en la página – Auch auf der Seite **82**

Cod.	m	-	EAN	N° x	x	x	€ m <sup>2</sup>	€ m	€	€
------	---	---	-----	------	---	---	------------------	-----	---	---

## CHIODI A U PLUS – U STAPLES PLUS – AGRAFES U PLUS – CLAVOS EN U PLUS – U-KLAMMERN PLUS

5 x 17 cm



1A070041	0.17	■	8002929078834	250	50	-	-	-	0,40	100,00
----------	------	---	---------------	-----	----	---	---	---	------	--------

## CHIODI A U – U STAPLES – AGRAFES U – CLAVOS EN U – U KLAMMERN

Confezione da 20 pezzi – Pack of 20 pieces – Sachet de 20 pièces – Envasado en bolsas de 20 unidades – Packung mit 20 Stk.

3.5 x 15 cm



3A021037	0.15	■	5010453210371	12	-	-	-	-	2,36	28,32
----------	------	---	---------------	----	---	---	---	---	------	-------

## CHIODI DI FISSAGGIO IN PLASTICA – PLASTIC BLACK PEGS – CLOUS DE FIXATION – CLAVOS DE ANCLAJE – SCHWARZE KUNSTSTOFFSTIFTE

Confezione da 20 pezzi – Pack of 20 pieces – Sachet de 20 pièces – Envasado en bolsas de 20 unidades – Packung mit 20 Stk.

11 cm



3A021039	0.11	■	5010453210395	12	100	-	-	-	5,68	68,16
----------	------	---	---------------	----	-----	---	---	---	------	-------

## CHIODI PER LEGNO – STAPLES FOR WOOD – AGRAFES POUR BOIS – GRAPAS – KLAMMERN FÜR HOLZ

Confezione da 100 pezzi – Pack of 100 pieces – Sachet de 100 pièces – Envasado en bolsas de 100 unidades – Packung mit 100 Stk.



99011500	0.02	■	8002929000507	10	90	-	-	-	3,80	38,00
----------	------	---	---------------	----	----	---	---	---	------	-------

Cod.	m	-	EAN	N° x		x			€ m²	€ m	€	€	
------	---	---	-----	------	--	---	--	--	------	-----	---	---	--

## ARCHETTI PER TUNNEL – TUNNEL HOOPS SET – ARCHES POUR TUNNEL – ARQUITOS – PFLANZTUNNEL RAHMEN SET

6 tubi da 85 cm + 3 raccordi da 15 cm – 6 tubes of 85 cm + 3 links of 15 cm – 6 arches de 85 cm + 3 raccords de 15 cm – Envasado de 6 arquitos de 85 cm + 3 accesorios de unión de 15 cm – Packung mit 6x85 cm Bögen + 3x15 cm Verbindungen



99530100	0.85+0.15		8002929038296	6	40	-	-	-	8,06	48,36
----------	-----------	--	---------------	---	----	---	---	---	------	-------

Anche a pagina – Also at page – Voir page – También en la página – Auch auf der Seite **95**



VIDEO  
TUTORIAL



MORE  
INFO

## PICCHETTI PER TUNNEL – TUNNEL PEGS – PIQUETS POUR TUNNEL – ESTACAS TUNEL – PLANZTUNNEL HERINGE

Confezione da **8 pezzi** – Pack of **8 pieces** – Sachet de **8 pièces** – Envasado en bolsas de **8 unidades** – Packung mit **8 Stk.**



99540100	0.21		8002929038302	12	77	-	-	-	2,39	28,68
----------	------	--	---------------	----	----	---	---	---	------	-------

Anche a pagina – Also at page – Voir page – También en la página – Auch auf der Seite **95**

## FERMATELO PER TUNNEL – TUNNEL CLIPS – CLIPS POUR TUNNEL – CLIPS DE SUJECION – PFLANZTUNNEL CLIPS

Per tubi da  $\varnothing$  9 mm a 18 mm – For tubes from about  $\varnothing$  9 mm to 18 mm – Pour tubes au diamètre allant de 9 mm à 18 mm environ – Para arquitos de  $\varnothing$  9 - 18 mm – Für Rohre von  $\varnothing$  9 mm bis 18 mm.

Confezione da **12 pezzi** – Pack of **12 pieces** – Sachet de **12 pièces** – Envasado en bolsas de **12 unidades** – Packung mit **12 Stk.**



99161100	-		8002929038319	12	90	-	-	-	1,52	18,24
----------	---	--	---------------	----	----	---	---	---	------	-------

Anche a pagina – Also at page – Voir page – También en la página – Auch auf der Seite **95**

## ETICHETTE PER PIANTE – PLANT LABEL – ETIQUETTE POUR PLANTE – ETIQUETAS PARA PLANTAS – ETIKETTEN FÜR PFLANZEN

Confezione da **25 pezzi, con matita** – Pack of **25 pieces, with pencil** – Sachet de **25 pièces, avec crayon** – Envasado en bolsas de **25 unidades, con lapiz** – Packung mit **25 Stk., mit Bleistifte**



1A160276	15 cm		8002929120892	20	-	-	-	-	2,06	41,20
----------	-------	--	---------------	----	---	---	---	---	------	-------

## EASY SEEDER

Seminatore manuale – Manual seed sower – Semoir manuel – Sembrador manual – Manueller sämann



1A160278	12.5 cm		8002929120915	12	-	-	-	-	1,09	13,08
----------	---------	--	---------------	----	---	---	---	---	------	-------



Cod.	m	-	EAN	N° x	x	x	€ m <sup>2</sup>	€ m	€	€
------	---	---	-----	------	---	---	------------------	-----	---	---

## SPAGO AGAVE – AGAVE TWINE – FICELLE EN AGAVE – CORDÓN DE AGAVE – AGAVESCHNUR



1A150534	60 m - 160 g		8002929118806	24	56	-	-	-	2,91	69,84
----------	--------------	--	---------------	----	----	---	---	---	------	-------

## RAFIA NATURALE – NATURAL RAFFIA – RAPHIA NATUREL – RAFIA NATURAL – NATURBAST



1A150520	50 g		8002929118738	24	77	-	-	-	1,61	38,64
99340132	80 g		8002929048721	30	-	-	-	-	2,72	81,60
1A150518	150 g		8002929118721	24	-	-	-	-	3,42	82,08

## SPAGO IN JUTA – JUTE TWINE – CORDE EN JUTE – CUERDA – JUTESCHNUR



1A160286	50 m - 80 g		8002929120984	12	175	-	-	-	1,62	19,44
99490200	100 m - 110 g		5010453878007	12	-	-	-	-	2,32	27,84

## PIATTINA IN CARTA PRETAGLIATA – PRE-CUT PAPER TWIST TIE – LIENS EN PAPIER ARMÉS ET PRÉDÉCOUPÉS – FLEJE PRECORTADO DE PAPEL – PLATTFORMKABEL AUS SCHON GESCHNITTENES PAPIER

Confezione da **100 pezzi** – Pack of **100 pieces** – Sachet de **100 pièces** – Envasado en bolsas de **100 unidades** – Packung mit **100 Stk.**



1A160275	15 cm		8002929120885	15	-	-	-	-	1,35	20,25
----------	-------	--	---------------	----	---	---	---	---	------	-------

## PIATTINA IN CARTA – PAPER TWIST TIE – LIENS EN PAPIER – FLEJE DE PAPEL – PLATTFORMKABEL AUF PAPIER

Con taglierina – With built-in cutter – Avec coupeuse – Con cortador – Mit Schneidemaschine



1A160274	50		8002929120878	24	-	-	-	-	2,05	49,20
----------	----	--	---------------	----	---	---	---	---	------	-------

Cod.	m	-	EAN	N° x	x	x	€ m <sup>2</sup>	€ m	€	€
------	---	---	-----	------	---	---	------------------	-----	---	---

## ANELLI IN PLASTICA – PLASTIC TWIST & CLIPS – ANNEAUX EN PLASTIQUE – ANILLOS DE PLASTICO – KUNSTSTOFF-VERBINDER

Confezione da 30 pezzi – Pack of 30 pieces – Sachet de 30 pièces – Envasado en bolsas de 30 unidades – Packing mit 30 Stk.



99410100	-		5010453816009	12	-	-	-	-	1,41	16,92
----------	---	--	---------------	----	---	---	---	---	------	-------

## PIATTINA PRETAGLIATA – PRE-CUT PLANT TWIST TIES – LIENS EN PLASTIQUE ARMÉS ET PRÉDÉCOUPÉS – FLEJE PRECORTADO – VORGESCHNITTENE VERSCHLUSSCLIPS



3A021705	0.10		5010453705006	12	-	-	-	-	1,45	17,40
1A150320	0.20		8002929117243	15	175	-	-	-	2,01	30,15

Confezione da 100 pezzi – Pack of 100 pieces – Sachet de 100 pièces – Bolsa 100 uds – Packing mit 100 Stk.

1A150322	0.20		8002929117250	8	120	-	-	-	5,41	43,28
----------	------	--	---------------	---	-----	---	---	---	------	-------

Mazzo da 1000 pezzi – Bundle of 1000 pieces – Sachet of 1000 pièces – Manajo 1000 uds – Bündel mit 1000 Stk.

## PIATTINA – PLANT TWIST TIE – LIEN PLASTIQUE ARMÉ – FLEJE – VERSCHLUSSCLIP

Con taglierina – With built-in cutter – Avec coupeuse – Con cortador – Mit Schneidemaschine



99021210	30.00		5010453841001	12	-	-	-	-	1,61	19,32
99021220	100.00		5010453909008	12	48	-	-	-	3,96	47,52

## RAFIA SINTETICA – SYNTHETIC RAFFIA – RAPHIA SYNTHÉTIQUE – RAFIA SINTETICA – SYNTHETISCHER BAST



99340133	200 g		8002929048738	50	54	-	-	-	1,84	92,00
----------	-------	--	---------------	----	----	---	---	---	------	-------

Cod.	m	-	EAN	N° x	x	x	€ m <sup>2</sup>	€ m	€	€
------	---	---	-----	------	---	---	------------------	-----	---	---

**TUBETTO AGRICOLO BIODEGRADABILE – BIODEGRADABLE PLANT STRETCH TIE – LIEN AGRICOLE BIODÉGRADABLE – TUBO AGRÍCOLA BIODEGRADABLE – BIOLOGISCH PFLANZEN AUSDEHNUNGS-VERBINDUNG**

TOP QUALITY



**METAL FREE**



1A170031	250 g-ø 3 mm*		8002929122001	16	-	-	-	-	4,49	71,84
----------	---------------	--	---------------	----	---	---	---	---	------	-------

\* ≈ 40 m

**TUBETTO AGRICOLO IN PVC – PVC PLANT STRETCH TIE – LIEN DE TUTEURAGE EN PVC – TUBO AGRÍCOLA EN PVC – PVC PFLANZEN AUSDEHNUNGS-VERBINDUNG**

TOP QUALITY



TOP QUALITY MATERIAL



**METAL FREE**

**1 kg**



1A160290	1 kg-ø 5 mm*		8002929121011	12	-	-	-	-	5,64	67,68
1A160291	1 kg-ø 2 mm**		8002929121028	12	-	-	-	-	5,64	67,68

\* ≈ 78 m

\*\* ≈ 240 m

**TUBETTO AGRICOLO IN PVC – PVC PLANT STRETCH TIE – LIEN DE TUTEURAGE EN PVC – TUBO AGRÍCOLA EN PVC – PVC PFLANZEN AUSDEHNUNGS-VERBINDUNG**

TOP QUALITY



TOP QUALITY MATERIAL



**METAL FREE**



1A160289	250 g-ø 3 mm*		8002929121004	16	-	-	-	-	2,50	40,00
1A150323	500 g-ø 3 mm**		8002929117267	10	-	-	-	-	3,36	33,60
1A160347	500 g-ø 3 mm**		8002929121493	10	-	-	-	-	3,36	33,60

\* ≈ 40 m

\*\* ≈ 80 m

**LEGACCIO ESTENSIBILE IN PVC – PVC STRETCH TIE – LIEN EXTENSIBLE EN PVC – CORDONES ELASTICOS EN PVC – PVC AUSZIEHBARER KUNSTSTOFFDRAHT**

Con tagliarina – With built-in cutter – Avec coupeuse – Con cortador – Mit Schneidemaschine



3A021057	30.00		5010453210579	12	-	-	-	-	2,61	31,32
----------	-------	--	---------------	----	---	---	---	---	------	-------

Cod.	m	-	EAN	N° x	x	x	€ m <sup>2</sup>	€ m	€	€
------	---	---	-----	------	---	---	------------------	-----	---	---

## FROGGY TWIST

Legaccio rana – Funny decoration to fasten plants – Décoration drôle pour attacher les plantes – Cordon decorativo para plantas – Dekoratives Schnürband für Pflanzen



2 pcs	1A160243	13.5 cm		8002929120694	50	-	-	-	-	1,89	94,50
-------	----------	---------	--	---------------	----	---	---	---	---	------	-------



## FLEX TIE

Legaccio flessibile armato – Soft flexible plant tie with steel wire core – Lien doux et flexible avec une âme en fil d'acier – Cordon flexible para plantas – Flexibles Schnürband für Pflanzen



	1A160280	5.00 - ø 5 mm		8002929120939	24	-	-	-	-	2,27	54,48
--	----------	---------------	--	---------------	----	---	---	---	---	------	-------

## LEGAPIANTE MORBIDO – FOAM TIE FOR PLANTS – LIEN SOUPLE POUR PLANTES – ABRAZADERA SUAVE – SCHAUMSTOFFVER-BINDUNG FÜR PFLANZEN

Confezione da 20 pezzi – Pack of 20 pieces – Sachet de 20 pièces – Envasado en bolsas de 20 unidades – Packung mit 20 Stk.



	3A142803	0.20		5010453350527	12	-	-	-	-	4,00	48,00
--	----------	------	--	---------------	----	---	---	---	---	------	-------

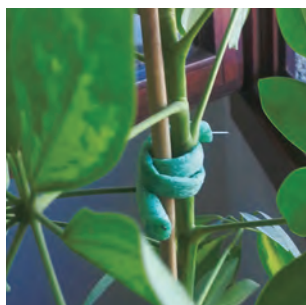

7

Cod.	m	-	EAN	N° x 	 x 	 x 	€ m <sup>2</sup>	€ m	€ 	€ 
------	---	---	-----	--	---	---	------------------	-----	---	---

## MINI TERMOMETRO PARETE – MINI-WALL THERMOMETER – MINI THERMOMÈTRE MURAL – MINI TERMOMETRO DE PARED – MINI-WAND-THERMOMETER



99560002	14.5x3 cm	<input type="checkbox"/>	5010453844002	12	-	-	-	-	2,31	27,72
----------	-----------	--------------------------	---------------	----	---	---	---	---	------	-------

## TERMOMETRO IN FAGGIO – WOODEN WALL THERMOMETER – THERMOMÈTRE MURAL EN BOIS – TERMOMETRO DE MADERA – HOLZ-WAND-THERMOMETER



99560004	20x3.5 cm	<input type="checkbox"/>	5010453847003	6	-	-	-	-	4,06	24,36
----------	-----------	--------------------------	---------------	---	---	---	---	---	------	-------

## TERMOMETRO FINESTRA – WINDOW THERMOMETER – THERMOMÈTRE DE FENÊTRE – TERMOMETRO DE VENTANA – FENSTER THERMOMETER



99560007	7.5x7.5 cm	<input type="checkbox"/>	5010453872005	6	-	-	-	-	3,36	20,16
----------	------------	--------------------------	---------------	---	---	---	---	---	------	-------

## IGROMETRO – HYGROMETER – HYGROMÈTRE – HIGROMETRO – HYGROMETER

Misura l'umidità nell'aria – Measures air humidity – Il mesure l'humidité de l'air – Medidor de la humedad en el aire – Misst die Luftfeuchtigkeit



99550004	5.5x7 cm	<input type="checkbox"/>	5010453851000	12	-	-	-	-	5,51	66,12
----------	----------	--------------------------	---------------	----	---	---	---	---	------	-------

Cod.	m	-	EAN	N° x	x	x	€ m²	€ m	€	€
------	---	---	-----	------	---	---	------	-----	---	---

## TESTER 3 IN 1

Sonda universale (PH, umidità, luce) – Universal tester (PH, light, humidity) – Sonde universelle (PH, Lumière, humidité) – Sonda universal (PH, humedad, luz) – Universaler Spannungsprüfer (PH, Licht, Feuchte)



1A160277	26 cm		8002929120908	6	-	-	-	-	10,73	64,38
----------	-------	--	---------------	---	---	---	---	---	-------	-------



## SONDA ACIDITÀ – PH TESTER – TESTEUR DE PH – MEDIDOR PH – MINI PH-TESTER



99550002	-		5010453624208	6	-	-	-	-	12,94	77,64
----------	---	--	---------------	---	---	---	---	---	-------	-------

7

## SONDA UMIDITÀ – MOISTURE TESTER – TESTEUR D'HUMIDITÉ – SENSOR DE HUMEDAD – MINI FEUCHTIGKEITS-TESTER



99550001	-		5010453624215	6	-	-	-	-	12,94	77,64
----------	---	--	---------------	---	---	---	---	---	-------	-------



## MERCHANDISING

### Espositori

Gli espositori Tenax, con il loro verde caratteristico e di grande impatto, connotano con stile il punto vendita e offrono soluzioni in grado di massimizzare il sell-out. Le strutture espositive Tenax vengono assegnate in base a condizioni di vendita e alla politica commerciale.

## MERCHANDISING

### Display stands

Tenax display stands, with their typical and high-impact green colour, give a touch of style to shops and offer solutions that can maximize sales. Tenax display structures are assigned on the basis of sales terms and policy.

## MERCHANDISING

### Présentoirs

Les présentoirs Tenax, de grand impact avec leur couleur verte caractéristique, définissent avec style le point de vente et offrent des solutions capables de maximiser les ventes. Les structures d'exposition Tenax sont attribuées selon les conditions de vente et la politique commerciale.

## MERCHANDISING

### Expositores

Los expositores Tenax, con el verde característico y de gran impacto, matizan con estilo el punto de venta y ofrecen soluciones en grado de maximizar el sell-out. Las estructuras expositivas Tenax se suministran en base a las condiciones de venta y a la política comercial.

## MERCHANDISING

### Aufsteller

Die Tenax Aufsteller, mit ihrem charakteristischen grün und mit großer Wirkung, kennzeichnen die Verkaufsstelle mit Stil und bieten Lösungen die den Verkauf maximieren können. Die Tenax Ausstellungsstrukturen werden gemäß Verkaufsbedingungen und Handelspolitik zugewiesen.

# TENAX



**DIY**

Per la vendita di prodotti in formato self-service.  
To sell products in self-service format.  
Pour la vente de produits en format libre-service.  
Para la venta de productos de autoservicio.  
Um Produkte im Selbstbedienungformat zu verkaufen.

L cm 95 - P cm 65  
H cm 180 + 30 cm crowner Tenax  
Cod. 1A110658



**DIY PROMO**

Ideale per attività promozionali in testata di gondola o in isole dedicate.  
For seasonal/rotational promotional activities.  
Pour les activités de promotions saisonnières/à rotation.  
Ideal para acciones promocionales.  
Für saisonale/wechselnde Werbeaktivitäten.

L cm 95 - P cm 65  
H cm 180 + 30 cm crowner Tenax  
Cod. 1A120116

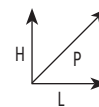

**FLOOR DISPLAY**

Per accessori e buste.  
For accessories and bags.  
Pour accessoires et sacs.  
Por accesorios y bolsas.  
Für Zubehör und Umschläge.

L cm 30.5 - P cm 40 - H cm 100  
Cod. 1A170065



**TUBULAR DISPLAY**

Per fascette e accessori.  
For plastic ties and accessories.  
Pour liens et accessoires.  
Por bridas y accesorios.  
Für Kunststoff-kabelbinder und Zubehör.

Ø cm 23 - H cm 100  
EMPTY DISPLAY Cod. 1A120255  
DISPLAY PRE-PACKED, CHOOSING FROM:  
Plastic ties (20 cm) Cod. 1A120234 (100 packs)



**HANGING DISPLAY**

Striscia per accessori.  
Hanging display unit.  
Dispositif d'affichage.  
Expositor de pared.  
Hängende aufsteller.

L cm 15 - P cm 98.5



**Espositori  
autoportanti**

**Self-standing  
displays**

**Présentoirs  
auto-portants**

**Expositores**

**Selbsttragende  
aufsteller**



**GABBIA IN LEGNO PROMO  
PROMO WOODEN CAGE  
CAGE EN BOIS PROMO  
JAULA DE MADERA PROMO  
WERBEKÄFIG AUS HOLZ**

L cm 86 - P cm 65 - H cm 79

Cod. 1A140054

**Espositori  
taglio a metro  
TGM**

**Bulk roll  
displays**

**Présentoirs  
découpe au mètre**

**Expositores  
al corte**

**Rollenständer  
für den zuschnitt**



**TGM RETI**

Espositore per la vendita assistita di rotoli al taglio.

**TGM FOR NETS**

Display for assisted sale of bulk rolls.

**TGM FILETS**

Présentoir pour la vente assistée de rouleaux au mètre.

**TGM MALLAS**

Expositor para la venta asistida de rollos al corte.

**TGM GITTER**

Für den kundenspezifischen Verkauf von Großrollen.

L cm 244 - P cm 60,5

H cm 193 + 30 cm crowner Tenax

Cod. 1A110657



**MAGNETI** per TGM (taglio a metro).

**MAGNETS** for TGM (cutting by meter).

**MAGNETS** pour TGM (coupe au mètre).

**IMANES** para TGM (al corte).

**MAGNETE** für TGM (Zuschnitt pro Meter).

L cm 15 - H cm 7



**TGM PRATI**

Per taglio a misura dei rotoli di prato da 1 e 2 metri di larghezza.

**TGM FOR SYNTHETIC TURFS**

To cut to measure lawn rolls measuring 1 and 2 metres wide.

**TGM PELOUSES**

Pour coupe sur mesure des rouleaux de pelouse de 1 et 2 mètres de large.

**TGM CÉSPEDES**

Para cortar a medida los rollos de césped de 1 y 2 m de ancho.

**TGM RASEN**

Genauer Zuschnitt von 1 und 2 m breitem Kunstrasen.

L cm 242 - P cm 80 - H cm 150

Cod. 1A130005

Cod.	m	-	EAN	N° x 	 x 	 x 	€ m <sup>2</sup>	€ m	€  	€  
------	---	---	-----	--	--	---	------------------	-----	---	---

## ESPOSITORE TGM RETI – DISPLAY TGM NETS – PRÉSENTOIR TGM FILETS – EXPOSITOR TGM MALLAS – GITTER TGM AUFSTELLER



1A170242	L cm 230 P cm 60 H cm 180	<input type="checkbox"/>	8002929123428	-	-	-	-	-	-	470,00
----------	---------------------------------	--------------------------	---------------	---	---	---	---	---	---	--------

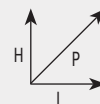

## ESPOSITORE TGM VERTICALE – DISPLAY VERTICAL TGM – PRÉSENTOIR TGM VERTICALE – EXPOSITOR TGM VERTICAL – VERTIKALER TGM AUFSTELLER



1A150489	L cm 142 P cm 55 H cm 221	<input type="checkbox"/>	8002929118479	-	-	-	-	-	-	780,00
----------	---------------------------------	--------------------------	---------------	---	---	---	---	---	---	--------

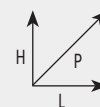

Cod.	m	-	EAN	N° x 	 x 	 x 	€ m <sup>2</sup>	€ m	€ 	€ 
------	---	---	-----	--	---	---	------------------	-----	---	---

## ESPOSITORE PER TUTORI – DISPLAY FOR PLANT SUPPORTS – PRÉSENTOIR POUR TUTEURS – EXPOSITORES PARA TUTORES – AUFSTELLER FÜR STÜTZEN



1A170051	L cm 48 P cm 49.5 H cm 110.5	<input type="checkbox"/>	8002929122124	-	-	-	-	-	-	140,00
----------	------------------------------------	--------------------------	---------------	---	---	---	---	---	---	--------

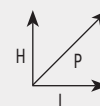

## ESPOSITORE PER TUTORI SMALL – SMALL DISPLAY FOR PLANT SUPPORTS – PRÉSENTOIR POUR TUTEURS SMALL – EXPOSITORES PARA TUTORES SMALL – AUFSTELLER FÜR STÜTZEN SMALL



1A150490	L cm 47 P cm 53 H cm 65	<input type="checkbox"/>	8002929118486	-	-	-	-	-	-	59,00
----------	-------------------------------	--------------------------	---------------	---	---	---	---	---	---	-------

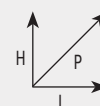

## ESPOSITORE PER TUTORI BIG – BIG DISPLAY FOR PLANT SUPPORTS – PRÉSENTOIR POUR TUTEURS BIG – EXPOSITORES PARA TUTORES BIG – AUFSTELLER FÜR STÜTZEN BIG



1A150491	L cm 74 P cm 53 H cm 65	<input type="checkbox"/>	8002929118493	-	-	-	-	-	-	59,00
----------	-------------------------------	--------------------------	---------------	---	---	---	---	---	---	-------

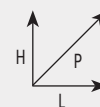

# 2019: News at glance

**TEXTSTYLE DARK**



**ALOHA**



**JAMAICA**



**DIVY 3D PANEL**



**DIVY 3D X-TENS**

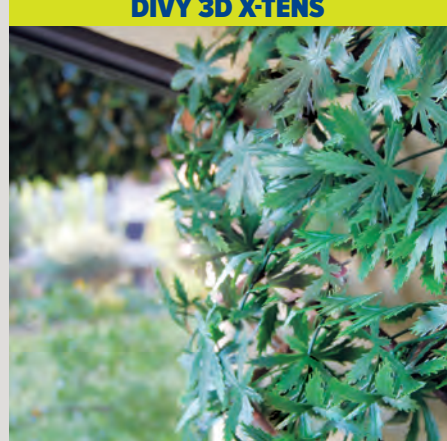

**DIVY 3D PLUS PHOTINIA**



**IRISH MAT 20**



Airy	17
Aloha <b>NEW</b>	53
Arcodecò	33
Aviary	25
Bahia	46
Bahia Anthracite	46
Bamboo Stick	118
Bamboo Tutor	106
Bamboo Up	107
Bermuda	44
Black & White Cover	100
Black Cover	101
C-Flex	23
Carryall Bag	119
Cintoflex C	23
Cintoflex D	25
Cintoflex E	24
Cintoflex M	24
Coat Film	92
Coat Film Plus	125
Cocopole	107
Coimbra	45
Coimbra Dark	45
Colorado	70
Corolla	117
Cover All	124
Cover HG	98
Cover Pro	96
Cuadrada 05	14
Cuadrada 10	15
Cuadrada 20	15
Defender	109
Defender Plus	108
Divy 3D Panel Buxus <b>NEW</b>	59
Divy 3D Panel Buxus Intense <b>NEW</b>	59
Divy 3D Panel Buxus Lilac <b>NEW</b>	59
Divy 3D Panel Fern <b>NEW</b>	61
Divy 3D Panel Helix <b>NEW</b>	60
Divy 3D Panel Photinia <b>NEW</b>	60
Divy 3D Panel Saltus <b>NEW</b>	60
Divy 3D Plus Laurus	65
Divy 3D Plus Photinia <b>NEW</b>	65
Divy 3D Trellis	64
Divy 3D X-Tens Acer Palmatum <b>NEW</b>	64
Divy 3D X-Tens Bamboo <b>NEW</b>	63
Divy 3D X-Tens Cyprus <b>NEW</b>	63
Divy 3D X-Tens Osmanthus	64
Divy 3D X-Tens Red Acer <b>NEW</b>	63
Divy Extra	69
Divy Hedera	67
Divy Laurus	67
Divy Laurus Net	68
Divy Optima	69
Divy X-Tens Hedera	66
Dot Cover	101
Dot Film	92
Early Tunnel	91

EcoQuadra	10
Exagon	16
Examet 10	29
Examet 25	29
Flora	102
Floret	30
Full Cover	99
Garden Bag	121
Glamour Pop Up Bag	120
Glamour Square Bag	120
Glamour Stand Bag	120
Goticdecò	32
GP Flex 1400	82
Hobby 10	19
Hobby 30	19
Hortonova <b>NEW</b>	104
Iridium Perla	110
Irish Mat 20 <b>NEW</b>	78
Irish Mat 25	78
Irish Mat 42	77
Jamaica <b>NEW</b>	54
Jolly	123
Levex Tube	122
Limit Garden	26
Microfender	113
Millennium	22
Mistral	17
Mosquito	128
Mr. Tomato	94
Net Film	125
Nilo Plus	71
Ondadecò	31
Ondamet	33
Ortoclima	88
Ortoclima Extra	86
Ortoclima Plus	87
Ortoflex	111
Ortoflex Bis	112
Painter Pad	126
Plamet 10	27
Plamet 20	28
Pratoblock	82
Quadra 05	11
Quadra 05 (treeguard)	114
Quadra 10	12
Quadra 20	13
Quadramet 10	28
Quadramet 20	28
Ranch	21
Rio	72
S 38 (mole net)	114
Saccoclima	90
Saccoclima Plus	90
Skip Bag Maxi	121
Soleado	52
Soleado Corten	50
Soleado Duo	47

Soleado Glam	50
Soleado HG	52
Soleado in White	49
Soleado Pro	51
Soleado Sport	48
Spiral Up Plus	105
Stand Up	106
Standard Green	79
Steel Up	105
Stick Up	118
Sun Film	93
Sunshine Kit	55
TexStyle All Black	39
TexStyle All Green	40
TexStyle Double	39
TexStyle Plus	40
TexStyle Privé	42
TexStyle Privé Champagne	42
TexStyle Privé Dark <b>NEW</b>	43
TexStyle Vip	41
TR	81
Trell Up	118
Treplas <b>NEW</b>	116
Triplet	18
Tropical	127
Tuboclima Plus	89
Utilfender	110
Wpc Flower Bed	34
Zanzibar	128
Zipclima Extra	89

**LINEA PET  
PET LINE  
LIGNE ANIMAUX  
LINEA PET  
HAUSTIERREIHE**

Bermuda	130
Floret	130
Hobby 10	132
Ranch	132
TR	131

**MERCHANDISING** 149

**ACCESSORI**

Anelli in plastica	144
Archetti per tunnel	95-142
Cambrette per legno	141
Chiodi a U	141
Chiodi a U GP FLEX	82-140
Chiodi a U Plus	141
Chiodi a U Special per TR	81-131-140
Chiodi di fissaggio in plastica	141
Chiodi metallici a testa piana	80-140
Chiodi metallici professionali per Cover PRO-HG	99-140
Clips di fissaggio per Corolla	117-136
Clips rete 35	54-136
Clips rete 50	54-136
Clips rete 100	54-136
Easy seeder	142
Etichette per piante	142
Fascette apri-chiudi	135
Fascette per cannicci	72-135
Fermatelo per tunnel	95-142
Filo metallico galvanizzato leggero	138
Filo metallico galvanizzato pesante	138
Filo metallico plastificato leggero	138
Filo metallico plastificato pesante	138
Filo plastificato extra	138
Fissarete per TexStyle	43-136
Fix-Tie L	134
Fix-Tie M	134
Fix-Tie re-Lock	135
Fix-Tie S	134
Fix-Tie XL	135
Flex Tie	146
Froggy twist	146
Igrometro	147
Legaccio estensibile in PVC	145
Legapiante morbido	146
Mat Duo	80-139
Mat Seal	80-139
Mat Stripe	80-139
Mini termometro parete	147
Paletto plastificato	138
Palo a "T" extra	137
Piattina	144
Piattina in carta	143
Piattina in carta pretagliata	143
Piattina pretagliata	144
Picchetto per Limit Garden	26
Picchetti per tunnel	95-142
Piedino piatto per Limit Garden	26
Rafia naturale	143
Rafia sintetica	144
Saetta extra	137
Sonda acidità	148
Sonda umidità	148
Spago agave	143
Spago in juta	143
Tendifilo metallico	137
Termometro finestra	147
Termometro in faggio	147
Tester 3 n 1	148
Tubetto agricolo biodegradabile	145
Tubetto agricolo in PVC	145
Tubetto agricolo in PVC Professional	145

**ACCESSORIES**

Adjustable plant ties	135
Agave twine	143
Biodegradable plant stretch tie	145
Cane screen ties	72-135
Clips 35	54-136
Clips 50	54-136
Clips 100	54-136
Easy seeder	142
Elastic tie for TexStyle	43-136
Extra T post	137
Extra arrow	137
Extra wire	138
Fix-Tie L	134
Fix-Tie M	134
Fix-Tie re-Lock	135
Fix-Tie S	134
Fix-Tie XL	135
Fixing clips for Corolla	117-136
Flat food for Limit Garden	26
Flat-head metal nails	80-140
Flex Tie	146
Foam tie for plants	146
Froggy twist	146
Hygrometer	147
Jute twine	143
Mat Duo	80-139
Mat Seal	80-139
Mat Stripe	80-139
Metal wire galvanized heavy	138
Metal wire galvanized light	138
Metal wire plastic-coated heavy	138
Metal wire plastic-coated light	138
Mini-wall thermometer	147
Moisture tester	148
Natural raffia	143
PH tester	148
PVC plant stretch tie	145
PVC plant stretch tie Professional	145
PVC Stretch tie	145
Paper twist tie	143
Picket for Limit Garden	26
Plant label	142
Plant twist tie	144
Plast post	138
Plastic black pegs	141
Plastic twist & clips	144
Pre-cut paper twist tie	144
Pre-cut plant twist tie	143
Professional metal staples for Cover PRO-HG	99-140
Staples for wood	141
Synthetic raffia	144
Tester 3 in 1	148
Tunnel clips	95-142
Tunnel hoops set	95-142
Tunnel pegs	95-142
U staples	141
U staples GP FLEX	82-140
U staples Plus	141
U staples Special for TR	81-131-140
Window thermometer	147
Wire tensioner	137
Wooden wall thermometer	147

**ACCESSOIRES**





Agrafes U	141
Agrafes U GP FLEX	82-140
Agrafes U Plus	141
Agrafes U Special pour TR	81-131-140
Agrafes métalliques professionnelles pour Cover PRO-HG	99-140
Agrafes pour bois	141
Anneaux en plastique	144
Arches pour tunnel	95-142
Clips 35	54-136
Clips 50	54-136
Clips 100	54-136
Clips de fixation pour Corolla	117-136
Clips pour tunnel	95-142
Clous de fixation	141
Clous métalliques à tête plate	80-140
Corde en jute	143
Cordon élastique pour TexStyle	43-136
Easy seeder	142
Etiquette pour plante	142
Ficelle en agave	143
Fil métallique galvanisé (léger)	138
Fil métallique galvanisé (lourd)	138
Fil métallique plastifié (léger)	138
Fil métallique plastifié (lourd)	138
Fil métallique plastifié extra lourd	138
Fix-Tie L	134
Fix-Tie M	134
Fix-Tie re-Lock	135
Fix-Tie S	134
Fix-Tie XL	135
Flex Tie	146
Froggy twist	146
Hygromètre	147
Lien agricole biodégradable	145
Lien de tuteurage en PVC	145
Lien de tuteurage en PVC Professional	145
Lien extensible en PVC	145
Lien plastique armé	144
Lien souple pour plantes	146
Liens en papier	143
Liens en papier armés et prédécoupés	143
Liens en plastique armés et prédécoupés	144
Liens pour canisses	72-135
Liens pour plantes réglables	135
Mat Duo	80-139
Mat Seal	80-139
Mat Stripe	80-139
Mini thermomètre mural	147
Piquet classique en "T"	137
Piquet en fer plastifié	138
Piquet pour Limit Garden	26
Piquets pour tunnel	95-142
Plaque de pied pour Limit Garden	26
Poteau de renfort	137
Raphia naturel	143
Raphia synthétique	144
Tendeur de fil	137
Tester 3 in 1	148
Testeur de PH	148
Testeur d'humidité	148
Thermomètre de fenêtre	147
Thermomètre mural en bois	147

**ACCESORIOS**

Abrazadera suave	146
Alambre metálico plastificado extra-grueso	138
Anillos de plástico	144
Arquitos	95-142
Bridas cañizo	72-135
Bridas multiuso	135
Clavos de anclaje	141
Clavos en U	141
Clavos en U GP FLEX	82-140
Clavos en U Especial para TR	81-131-140
Clavos en U Plus	141
Clavos metálicos de cabeza plana	80-140
Clavos metálicos profesionales para Cover PRO-HG	99-140
Clips de fijación para Corolla	117-136
Clips de sujeción	95-142
Clips malla 35	54-136
Clips malla 50	54-136
Clips malla 100	54-136
Cordón de agave	143
Cordones elasticos en PVC	145
Cuerda	143
Easy seeder	142
Estacas tunel	95-142
Etiquetas para plantas	142
Fijadora para TexStyle	43-136
Fix-Tie L	134
Fix-Tie M	134
Fix-Tie re-Lock	135
Fix-Tie S	134
Fix-Tie XL	135
Fleje	144
Fleje de papel	143
Fleje precortado	144
Fleje precortado de papel	143
Flex Tie	146
Froggy twist	146
Grapas	141
Higrometro	147
Hilo metálico galvanizado grueso	138
Hilo metálico galvanizado ligero	138
Hilo metálico plastificado grueso	138
Hilo metálico plastificado ligero	138
Mat Duo	80-139
Mat Seal	80-139
Mat Stripe	80-139
Medidor PH	148
Mini termometro de pared	147
Pie plano para Limit Garden	26
Piquete para Limit Garden	26
Poste de apoyo	137
Poste de hierro	138
Poste en forma de T	137
Rafia natural	143
Rafia sintetica	144
Sensor de humedad	148
Tensor metalico de hilos	137
Termometro de madera	147
Termometro de ventana	147
Tester 3 in 1	148
Tubo agricola biodegradable	145
Tubo agricola en PVC	145
Tubo agricola en PVC Profesional	145

**ZUBEHÖR**

Agaveschnur	143
Befestigungs-Set für Corolla	117-136
Biologisch Pflanzen Ausdehnungs-Verbindung	145
Der klassische "T"-Pfosten	137
Drahtspanner	137
Easy Seeder	142
Erdspieß für Limit Garden	26
Etiketten für Pflanzen	142
Fensterthermometer	147
Fix-Tie L	134
Fix-Tie M	134
Fix-Tie re-Lock	135
Fix-Tie S	134
Fix-Tie XL	135
Flex Tie	146
Froggy twist	146
Fuss für Limit Garden	26
Holz-Wand-Thermometer	147
Hygrometer	147
Juteschnur	143
Klammern 35	54-136
Klammern 50	54-136
Klammern 100	54-136
Klammern für Holz	141
Kunststoff-Verbinder	144
Kunststoffbeschichteter Draht	138
Kunststoffbeschichteter Eisenpfosten	138
Mat Duo	80-139
Mat Seal	80-139
Mat Stripe	80-139
Metalldraht Dicker kunststoff-beschichteter	138
Metalldraht Dicker verzinkter	138
Metalldraht Dünner kunststoff-beschichteter	138
Metalldraht Dünner verzinkter	138
Metallische nägels mit flachkopf	80-140
Mini PH-Tester	148
Mini feuchtigkeits-Tester	148
Mini-Wand-Thermometer	147
Naturbast	143
PVC Ausziehbarer Kunststoffdraht	145
PVC Pflanzen Ausdehnungs-Verbindung	145
PVC Pflanzen Ausdehnungs-Verbindung Professional	145
Pflanztunnel Clips	95-142
Pflanztunnel Rahmen Set	95-142
Planztunnel Heringe	95-142
Plattformkabel auf Papier	143
Plattformkabel aus schon geschnittenes Papier	143
Profi Metallklammern für Cover PRO-HG	99-140
Schaumstoffver-Bindung für Pflanzen	146
Schilfrohr- Befestigungen	72-135
Schwarze Kunststoffstifte	141
Synthetischer Bast	144
Tester 3 in 1	148
U-Klammern	141
U-Klammern GP FLEX	82-140
U-Klammern Plus	141
U-Klammern Spezial für TR	81-131-140
Verschlussclip	144
Verstellbare Pflanzen-Verbindungen	135
Verstärkungspfosten	137
Vorgeschnittene Verschlussclips	144
Zaunbefestigung für TexStyle	43-136

				
Confezioni per UDV (unità di vendita) Packs per selling unit Conditionnement pour UVC (unité de vente conditionnée) Paquetes por UDV (unidad de venta) Packungen je VKE (Verkaufseinheit)	UDV (cartoni) per pallet Selling units (boxes) per pallet UVC (cartons) par palette UDV (cajas) por pallet VKE (Kartons) je Palette	UDV (rotoli) per pallet Selling units (rolls) per pallet UVC (rouleaux) par palette UDV (rollos) por pallet VKE (Rollen) je Palette	€ a confezione (rotolino o busta) € per pack (roll or bag) € par conditionnement (petit rouleau ou sachet) € por paquete (rollo o bolsa) € je Packung (kleine Rolle oder Tasche)	€ a UDV (cartone o rotolo) € per selling unit (box or roll) € par UVC (carton ou rouleau) € por UDV (caja o rollo) € je VKE (Karton oder Rolle)

NOTA SUI PREZZI

I prezzi a metro quadro e a metro lineare sono ottenuti dal prezzo del rotolo e vengono riportati con arrotondamento alla seconda cifra decimale.

Tenax si riserva in qualsiasi momento il diritto di apportare modifiche ai propri prodotti ed al contenuto di listini e cataloghi, senza l'obbligo di preavviso. I dati contenuti sono basati sulle conoscenze disponibili al momento della stampa e possono essere soggetti a modifiche. È esclusa qualsiasi responsabilità per errori di stampa. Tutti i diritti di proprietà e copyright sono riservati. È proibita qualsiasi riproduzione di testi o fotografie, salvo espressa autorizzazione da parte di Tenax spa.

PRICES NOTATION

Prices per square metre and per linear metre result from roll prices and are rounded to two decimal places.

Tenax reserves the right at any time and without a prior notice to make changes to the products and contents of the catalogues and price lists. We do not assume any responsibility for printing errors. All property rights and copyright are reserved. No reproduction of the text or photographs is allowed, unless specifically authorized by Tenax.

REMARQUE SUR LES PRIX

Les prix au mètre carré et au mètre linéaire sont obtenus à partir du prix du rouleau et sont arrondis à la deuxième décimale.

Tenax SPA se réserve le droit, à tout moment et sans préavis, d'apporter des modifications à ses produits, au contenu de ses catalogues et à ses prix. Il ne saurait être tenu responsable des erreurs d'impression. L'ensemble des textes, illustrations et images reproduits dans le catalogue Tenax sont réservés au titre du droit d'auteur ainsi qu'au titre de la propriété intellectuelle, ce, pour le monde entier. Toute reproduction totale ou partielle du catalogue est strictement interdite sans l'autorisation préalable de Tenax SPA.

NOTA SOBRE LOS PRECIOS

Los precios por metro cuadrado y por metro lineal se calculan con el precio del rollo, y se indican redondeando a la segunda cifra decimal.

Tenax se reserva el derecho de aportar modificaciones a los propios productos y al contenido de listas de precios y catálogos en cualquier momento, sin aviso previo. Los datos contenidos se basan en conocimientos disponibles en el momento de la impresión y pueden ser modificados. Se excluye cualquier responsabilidad por errores de imprenta. Todos los derechos de propiedad y copyright están reservados. Se prohíbe cualquier reproducción de textos o fotografías, salvo autorización expresa por parte de Tenax spa.

ANGABE

Die Preise pro Quadrat- und Längengemeter ergeben sich aus dem Rollenpreis und werden mit Abrundung auf die zweite Dezimalstelle angegeben.

Tenax behält sich jederzeit das Recht vor, die eigenen Produkte sowie den Inhalt von Preislisten und Katalogen ohne Vorankündigung zu verändern. Die enthaltenen Daten basieren auf den zum Druckzeitpunkt verfügbaren Kenntnissen und können Veränderungen unterliegen. Jegliche Verantwortung für Druckfehler wird ausgeschlossen. Alle Eigentums- und Urheberrechte sind vorbehalten. Jegliche Wiedergabe von Texten oder Fotografien ist ohne ausdrückliche Genehmigung der Tenax Spa untersagt.



**1) PREZZI**

I prezzi esposti nel presente listino sono quelli validi al momento della spedizione della merce e si intendono IVA esclusa. Tenax si riserva di variare prezzi, misure e condizioni senza obbligo di alcun avviso. Ove previsto sarà addebitato il contributo Polleco.

**2) ORDINI**

Gli ordini devono pervenire in base alle caratteristiche riportate nella descrizione degli articoli del presente listino. Le ordinazioni si intendono conferite previa totale conoscenza ed approvazione espressa, col mezzo dell'ordine, esclusivamente delle presenti condizioni generali di vendita; salvo accordi particolari accettati dai contraenti. Tutti gli ordini sono irrevocabili da parte del Committente, ma potranno non essere evasi a insindacabile giudizio di Tenax e senza obbligo di giustificazione. Gli ordini si intendono assunti salvo approvazione della casa. È richiesto un quantitativo minimo di ordine pari ad Euro 500 netti.

**3) PAGAMENTI**

Il pagamento della fornitura deve avvenire secondo i tempi e le forme specificate nell'ordine. Permane in capo al committente il rischio della trasmissione delle somme, qualunque sia il mezzo prescelto. Non sono ammessi arrotondamenti di sorta. Per nessuna ragione e a nessun titolo il Committente può differire i pagamenti oltre le scadenze pattuite, anche in seguito a ritardi nella consegna dei materiali, ed a contestazioni di qualsiasi natura. Ogni ritardo nei pagamenti comporterà l'addebito di interessi al tasso ufficiale di sconto vigente aumentato di tre punti, oltre le spese di comunicazioni relative, salvo la possibilità di richiedere il maggior danno. Le fatture di Tenax non contestate a mezzo di lettera raccomandata entro quindici giorni dalla data del timbro postale di ricevimento si intendono integralmente accettate.

**4) RISERVA DI PROPRIETÀ**

La vendita è fatta con riserva di proprietà e, pertanto, le merci restano di esclusiva proprietà di Tenax fino all'avvenuto intero pagamento del prezzo.

**5) CONSEGNA E TRASPORTI**

I termini di consegna ancorché confermati sono sempre meramente indicativi, in ogni caso non si risponde per ritardi dovuti ad imprevisti, scioperi, agitazioni, o difficoltà nei trasporti o negli approvvigionamenti. La consegna avviene presso il deposito indicato da Tenax. Se per un motivo qualsiasi non dipendente da Tenax, una volta pronta la fornitura il Committente non abbia provveduto al ritiro, la consegna si intende ad ogni effetto eseguita col semplice avviso di merce pronta. Con tale consegna tutti i rischi sul materiale si trasferiscono al Committente, inoltre, Tenax si riserva di addebitare al Committente le spese di magazzino, custodia, assicurazione. Da tale data decorreranno anche i termini per il pagamento. La merce viaggia a rischio e pericolo del Committente. Ogni eventuale danneggiamento, disservizio o difformità rispetto alla bolla di accompagnamento dovrà essere contestato al Vettore dal Committente, a suo nome e nel suo interesse dandone solo comunicazione scritta con r.r. a Tenax. È facoltà di Tenax eseguire consegne parziali. I particolari imballaggi richiesti dal Committente, comunque non standard, o previsti nel listino prezzi sono addebitati in fattura.

**6) DATI TECNICI**

I dati e le istruzioni risultanti da cataloghi, prospetti e fogli informativi di Tenax si intendono a carattere indicativo e non impegnano la responsabilità di Tenax per eventuali inesattezze. Tenax si riserva di apportare ai prodotti le modifiche che si rendessero necessarie o convenienti. Il Committente si impegna espressamente a trattare come confidenziali le informazioni tecniche, commerciali o di altra natura, ricevute come tali da Tenax, di cui venga a conoscenza in connessione con l'esecuzione dell'Ordine.

I prodotti sono soggetti a termoretrazione: le misure espresse possono, perciò, subire variazioni.

**7) LIMITAZIONI**

Il Committente si impegna ad utilizzare i prodotti acquistati secondo le prescrizioni e per gli usi indicati da Tenax, di cui si dichiara già edotto, e si impegna, a sua volta, ad istruire gli ulteriori acquirenti su tali modalità e prescrizioni.

**8) RESPONSABILITÀ**

Tenax declina la propria responsabilità per ogni eventuale danno a persone o cose che possa derivare da un uso improprio dei prodotti, non conforme alle modalità previste o da una loro mancata corretta conservazione.

**9) GARANZIA**

La garanzia prestata al Committente è limitata alla sostituzione gratuita dei prodotti con accertati difetti di fabbricazione. La garanzia è esclusa in caso di manomissioni, in caso di morosità e quando i difetti siano provocati da incuria, uso non consentito o cattiva conservazione da parte del Committente. È esclusa inoltre quando la merce sia stata in tutto o in parte rivenduta o usata. La merce contestata deve restare a disposizione di Tenax per qualsiasi ispezione. Non saranno accettati reclami se non comunicati a mezzo di lettera raccomandata entro otto giorni dall'arrivo della merce oggetto del reclamo o entro otto giorni dalla scoperta dei vizi occulti; in tale ultimo caso il termine per la denuncia è di un anno dall'arrivo della merce. Tenax declina ogni responsabilità per eventuali azioni intentate da terzi contro i prodotti con l'accusa di contraffazione di brevetti. Le spese e gli eventuali danni derivanti dalla rivendita o dall'utilizzo di prodotti dichiarati infrangenti saranno a carico del Committente.

**10) FORO COMPETENTE**

Foro competente è esclusivamente quello di Lecco.

**Servizio Clienti**

Tel. 039/9219300 Fax 039/9219290

www.tenax.net

**1) PRICES**

Prices listed in this Price List are valid at the moment of the shipment of the Goods. VAT is not included. Tenax reserves the right to vary the prices, without any obligation to notify the Customer.

**2) ORDERS AND SPECIFICATIONS**

Orders shall be received in accordance to the products description given in valid Price List.

Orders are submitted under full knowledge and acceptance of Tenax sale terms and conditions, unless differently agreed between the parties. All orders are irrevocable by the Customer, but still subjected to Tenax approval. Tenax reserves the right not to accept them, without any obligation to justify it to the Customer. Minimum order is euro 500, net amount.

**3) TERMS OF PAYMENTS**

Payment have to comply with terms and conditions specified on the order.

The Customer will remain liable for money transfer risk. Any kind of rounding is not allowed. For no reason the Customer can defer payments beyond the deadline established, even in case of late delivery or any kind of claims. Interest will be charged for any payment delay at current bank rate, plus three percentage, plus the cost of notices, provided that Tenax could always claim additional damages. If Tenax invoices will not be disputed by registered mail, within fifteen days from the postmark date of receipt, will be considered fully accepted.

**4) PROPERTY RESERVATION**

Sales are conditional sales, therefore goods shall remain in the exclusive property of Tenax, until full payment of the total amount.

**5) DELIVERY**

Delivery dates, even if confirmed, are always indicative. In any case Tenax is not liable for delays due to unforeseeable events, strikes, riots, or difficulties in transport or supplying.

Goods shall be picked up of at the warehouse indicated by Tenax.

If, for any reason not depending on Tenax, the Customer does not collect the ready goods, the delivery is meant to be carried out, by the simply giving notice of ready goods. Therefore with this delivery all the risks are transferred to the Customer. In addition, Tenax may charge the Customer of the cost of warehousing, storage and insurance. From that date, the terms for payment will also take place.

The goods travel under the exclusive responsibility of the Customer. Any damage or claim shall be made by the Customer directly to the Carrier, and by giving written communication to Tenax with registered mail.

Tenax is allowed to make partial deliveries. Any special packaging requested by the Customer and not included in the price list will always be invoiced.

**6) TECHNICAL DATA**

All data and instructions included in Tenax catalogues, brochures and leaflets are only indicative and Tenax do not undertake any responsibility for any inaccuracies. Tenax reserves the right to make any changes to products that may be necessary. The Customer expressly undertakes to keep confidential all technical, commercial or any other kind of information received as such by Tenax, as well as all reserved information he becomes aware during the execution of the order. The products can suffer some thermo-shrinkage and dimensions may vary.

**7) RESTRICTIONS**

The Customer undertakes to use the purchased products in accordance with the requirements and the purposes indicated by Tenax, of which the Customer is hereby informed. Further, the Customer will also educate any additional purchasers about these terms and requirements.

**8) RESPONSABILITY**

TENAX shall not be responsible for any damage to persons or properties, which may occur by improper use of the products, not in accordance with the procedures set, or caused by their improper storage.

**9) WARRANTY**

The warranty provided to the Customer is limited to the free replacement of the products with proven manufacturing defects. Warranty can not be applied in case of misuse or in defaulting and when the defects are caused by negligence, unauthorized use or poor maintenance provided by the Customer. It is also excluded when the goods have been totally or partially sold or used. The defective goods must be available for any inspection of Tenax. No claims will be accepted if not communicated by registered letter, within eight days from the date of the arrival of the goods that are subject of the complaint, or within eight days from the discovery of hidden defects. In this last case, the deadline for the complaint is one year from the date of the arrival of the goods. Tenax shall not be liable for any action against products, patent infringement action, carried on by third parties.

The costs and damages resulting from the resale or the use of the infringing products will be paid by the Customer.

**10) JURISDICTION**

The Court of Lecco, Italy will be the exclusive jurisdiction.

**Customer Service**

Ph.+39 039/9219300 Fax+39 039/9219290

www.tenax.net



Moderno, facile da navigare, con informazioni e contenuti aggiuntivi e immagini di grande impatto estetico. Il sito Tenax è anche ottimizzato per i device portatili come Smartphone e Tablet per una consultazione facile anche on the go.

Modern, easy to browse, with additional information and content and beautiful images. Our Tenax website is optimized for mobile devices like Smartphones and Tablets for an excellent user experience also on-the-go.

Moderne, facile à consulter, avec des informations et des contenus supplémentaires et des images d'un grand impact esthétique. Le site Tenax est également optimisé pour les Smartphones et les Tablettes pour en faciliter l'accès même en déplacement.

Moderno, fácil de navegar, con informaciones y contenidos adicionales e imágenes de gran impacto estético. El sitio Tenax también está optimizado para dispositivos portátiles como Smartphones y Tablets para consultar fácilmente on the go.

Modern, einfach zu surfen, mit zusätzlichen Informationen und Inhalten sowie sehr ästhetischen Bildern. Die Tenax Website ist auch für tragbare Geräte wie Smartphone oder Tablet optimiert, zum einfachen Nachschlagen auch unterwegs.

Le 4 sezioni presenti in homepage **GARDEN&DIY** **PROFESSIONAL** **GEOSYNTHETICS** **INDUSTRY** guidano con chiarezza tra le gamme di Tenax e invogliano la navigazione e l'approfondimento.

The 4 sections on the homepage **GARDEN&DIY** **PROFESSIONAL** **GEOSYNTHETICS** **INDUSTRY** clearly guide among the Tenax product ranges and encourage users to browse the site and read the insights.

Les 4 sections de la page d'accueil **GARDEN&DIY** **PROFESSIONAL** **GEOSYNTHETICS** **INDUSTRY** vous guident avec clarté parmi les gammes de Tenax et vous incitent à une navigation approfondie.

Las 4 secciones presentes en la homepage **GARDEN&DIY** **PROFESSIONAL** **GEOSYNTHETICS** **INDUSTRY** guían con claridad entre las gamas de Tenax e inducen a navegar y a profundizar.

Die 4 auf der Homepage präsenten Bereiche **GARDEN&DIY** **PROFESSIONAL** **GEOSYNTHETICS** **INDUSTRY** führen klar durch die Tenax Palette und ermuntern zum Surfen und zur Vertiefung.

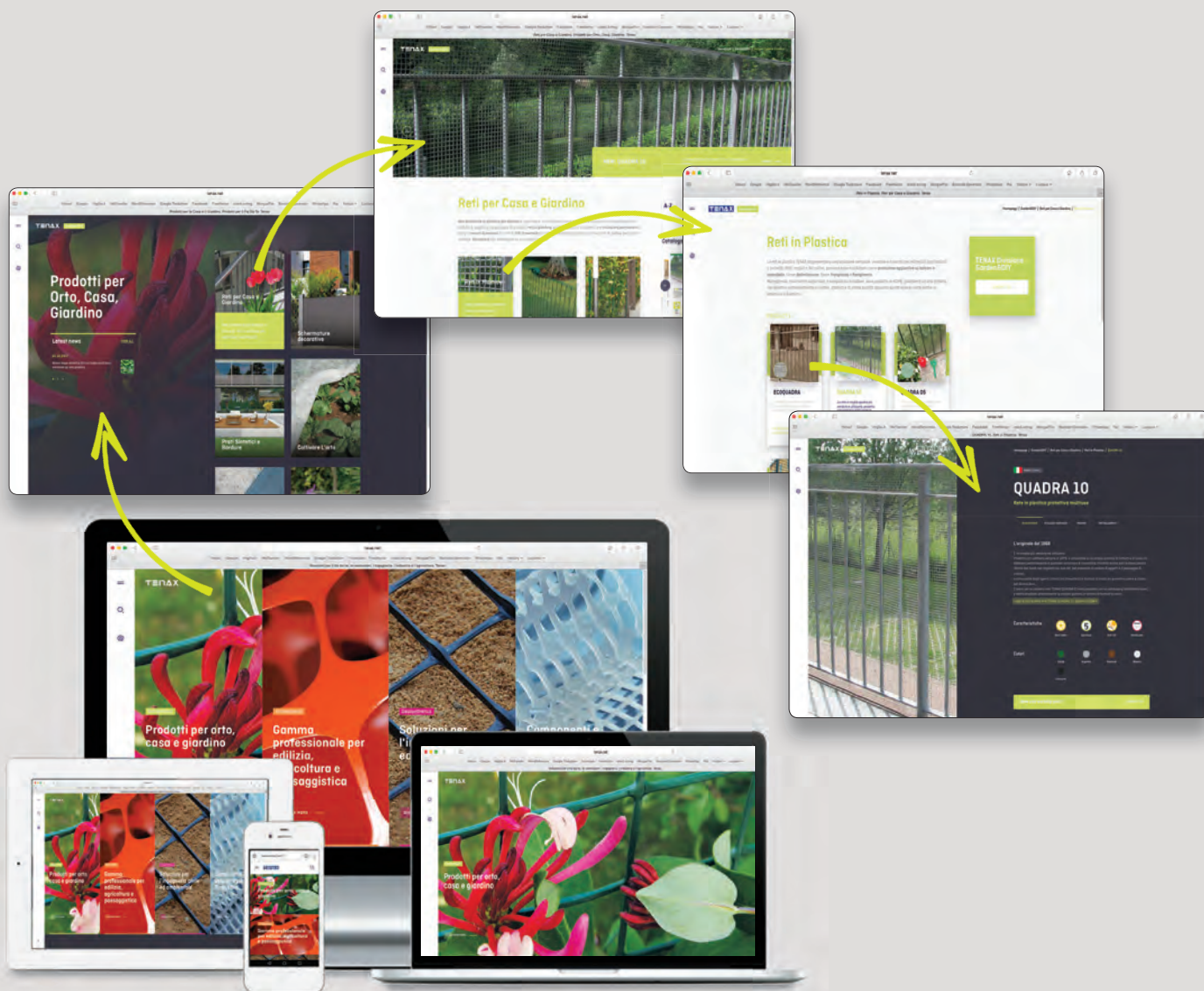



**TENAX SpA**

---

Via dell'Industria, 3  
23897 Viganò (LC) Italy

☎ +39 039 92191

☎ +39 039 9219290

✉ [customer.service@tenax.net](mailto:customer.service@tenax.net)

---

**[www.tenax.net](http://www.tenax.net)**

